

# GENERAL CATALOGUE



SYSTEMS

CO<sub>2</sub> T/RH% Kwh  
CO<sub>2</sub> Kwh  
Kwh T/RH%

We make the best control instruments, probably. And we also save energy, naturally.

PROGRAMMABLE CONTROLLERS

PARAMETRIC CONTROLLERS





# INDEX

<b>THE COMPANY</b>	<b>6</b>
<b>APPLICATIONS</b>	<b>8</b>
<b>PRODUCTS</b>	<b>10</b>
<b>SYSTEMS</b>	<b>10</b>
<b>SYSTEMS</b>	<b>11</b>
XCENTER – centralized management	14
XWEB300D – alarm management and controlling	18
XWEB500 – XWEB500D – monitoring and controlling	20
XWEB3000 – industrial monitoring and controlling	22
XWEB5000 – monitoring, controlling and supervising	24
XWEB ACCESSORIES – wireless modules – power analysis	31
XJA-XJP-XJR – relay and acquisition modules	32
<b>PROGRAMMABLE CONTROLLERS</b>	<b>34</b>
<b>PROGRAMMABLE CONTROLLERS</b>	<b>35</b>
iProGENIUS – general applications – high connectivity	36
XEV20D – stepper electronic expansion valves management	43
ACCESSORIES – wiring – modems	45
<b>PARAMETRIC CONTROLLERS</b>	<b>46</b>
<b>GENERAL PURPOSE REFRIGERATION CONTROLLERS</b>	<b>47</b>
PRIME CX – NT, MT and LT applications – serial output	48
PRIME D – NT, MT and LT applications	53
XR100/500 – NT, MT and LT applications – RS485 output	56
THERMOMETER – LCD & LED thermometers	63
<b>WING REFRIGERATION CONTROLLERS</b>	<b>65</b>
WING BASIC – NT, MT and LT applications – compact/split format	66
WING 200/500 – NT, MT and LT applications – compact/split format – RS485 output	73
<b>HACCP REFRIGERATION CONTROLLERS</b>	<b>79</b>
XR700-XW700 – NT, MT and LT applications – serial output	80
XDL – NT, MT and LT applications	86
<b>MULTIPLEXED CABINET REFRIGERATION CONTROLLERS</b>	<b>87</b>
XM – NT and LT applications – serial output	88



<b>ELECTRONIC EXPANSION VALVE DRIVERS</b>	<b>95</b>
XEV – superheat regulation – serial output	96
<b>REFRIGERATED ROOM &amp; TEMPERATURE/HUMIDITY CONTROLLERS</b>	<b>99</b>
XLR100 COOL MATE – NT, MT and LT applications – serial output	100
XLR400 COOL MATE – NT and LT applications – dual temperature management – serial output	102
XLH200/300 COOL MATE – NT and LT applications and maturing rooms – temperature/humidity management – serial output	104
XW200/500 + V-KIT – MT and LT applications – split format – serial output	106
<b>BLAST CHILLER/FREEZER REFRIGERATION CONTROLLERS</b>	<b>107</b>
XB – blast chiller and temperature maintenance applications – serial output	108
<b>COMBINED TEMPERATURE/HUMIDITY REFRIGERATION CONTROLLERS</b>	<b>111</b>
XH – MT and LT applications, maturing rooms and freezing/proving cabinet applications – serial output	112
<b>DUAL TEMPERATURE REFRIGERATION CONTROLLERS</b>	<b>117</b>
XR400-XW400 – NT, MT and LT applications – serial output	118
<b>COMPRESSOR RACK REFRIGERATION CONTROLLERS</b>	<b>121</b>
XC400/600 – up to 6 screw compressor/fan output applications – serial output	122
XC200L – up to 6 screw compressor and 4 fan output industrial applications – serial output	125
XC700/800/900M – up to 11 compressor/fan output applications – serial output	128
XC1000D – up to 15 compressor/fan output applications – serial output	132
<b>REFRIGERATED TRUCK CONTROLLERS</b>	<b>139</b>
XW20/35/40/60/300 – NT, MT and LT applications – compact/split format	140
<b>FAN SPEED CONTROLLERS</b>	<b>143</b>
XV – single-phase fan speed management	144
<b>TIME/TEMPERATURE/HUMIDITY/PRESSURE CONTROLLERS</b>	<b>147</b>
XT100 – NTC, PTC, Pt100, TcJ, TcK, TcS, 4÷20mA, 0÷1V, 0÷10V multi-probe input – serial output	148
XT200 – NTC, PTC, Pt100, TcJ, TcK, TcS multi-probe input, with time/temperature cycle management – serial output	153
XT400 – time/temperature cycle management – serial output	155
XF – cooking oven applications	157
<b>PROBES &amp; ACCESSORIES</b>	<b>160</b>
<b>PROBES</b>	<b>161</b>
<b>ACCESSORIES</b>	<b>167</b>
<b>DIMENSIONS &amp; CUT OUT</b>	<b>174</b>
<b>GENERAL TECHNICAL FEATURES</b>	<b>179</b>
<b>CORPORATE AND HOMOLOGATIONS</b>	<b>179</b>



## THE COMPANY

**HEADQUARTERS** Over 15.200m<sup>2</sup> surface area, 3.100m<sup>2</sup> of production area, 800m<sup>2</sup> of office space and over 20 years of experience in this highly specialised field of business. These statistics express the **dynamism** of a **Company** that has positioned itself among world leaders of electronics, offering a range of products that provide innovative solutions to meet the needs of the **air conditioning, industrial and commercial refrigeration and catering markets.**



**SALES TRAINING** World wide, our products are distributed and supported in **over 70 countries**, by a sales network of experienced and **qualified personnel**, guaranteeing the correct selection of controllers and an efficient after sales service. Competence, professionalism, and courtesy make our Customer Service Dept stand out. It provides our distributors and customers alike with technical support, solutions and concise answers to issues that may arise. Constant **technological development and innovation** of our products make us stand out in the market as the strategic choice for most users. This and the continuous growth of our product range requires constant training for our own staff and our distributors. To meet this challenge a fully equipped training facility with the most advance computer tecnology has been developed at our Belluno base.



## RESEARCH DEVELOPMENT PRODUCTION

Continuous **research and development** means that all our controllers feature the latest generation of microprocessors. Giving due consideration to the actual needs of many users leads us to develop Dixell's fast and simple programming methods. Most operating features are carefully developed through listening closely to the requirements of our many users. Our "Research and Development" and our "Production" departments are highly flexible, which means they can respond quickly to specific customer requirements and offer appropriate solutions. Highly sophisticated equipment is now employed in the development and control of manufacturing. Here delicate and repetitive tasks are mostly carried out by "state of the art" **automatic systems**.



**QUALITY** Dixell has been awarded with **ISO9001 certificate** and it constantly commits itself to quality in everything it does. The quality system of Dixell is conform to the Quality System Standard **UNI EN ISO 9001:2000**.



**ENVIRONMENT** Dixell pays particular attention to the **respect of the environment** and is constantly looking for new solutions in accordance with this philosophy. This is why it is putting its efforts into creating regulators that allow high **energy savings**, respecting the strict **RoSH** and **RAEE** standards (**European Directives 2002/95/CE and 2002/96/CE**) and using **packing materials** that are in accordance with **2004/12/CE European Directive**, that also guarantees noteworthy advantages for the end user.



## APPLICATIONS

### INDUSTRIAL REFRIGERATION

**Industrial refrigeration** requires the control of many different conditions to guarantee that products are processed and stored correctly. **Temperature, pressure** and **humidity** must be kept under control with reliable devices that are also simple to manage. Whether we are dealing with a **compressor rack controller** or the **smallest refrigerator** or **refrigerated transport**, controllers must provide total solutions that provide complete control. If there is an alarm, it is necessary to be advised quickly in order to intervene without delay. Therefore depending on the application Dixell provides remote assistance systems for local **monitoring**, for **supervising** or remote **control** including via **internet**. Where there are many points of sale, such as big distribution centres, the centralized management software for the Call Center is available.



### COMMERCIAL REFRIGERATION

In today's modern supermarkets, control system technology for **commercial refrigeration**, both for **cabinets** and compressor racks, plays a fundamentally vital role, both for the designer and the consumer. The concepts of integration, remote access, energy savings and functional aesthetics are important considerations in this key field of refrigeration. From the simple controller for **plug-in applications** to the most sophisticated master + multiple slave system **for multiplexed cabinets**, Dixell presents its vast experience by offering products with excellent performance and durability.





**FOOD SERVICE  
COOKING**

Dixell is equally competent in the field of **cooking**, just as it is in the field of refrigeration or **blast chiller** processes used in freshly-cooked food conservation. Dixell's solutions to the recent introduction of food hygiene regulations (HACCP) offer immediate advantages in terms of cost, time and operation of systems.



**EQUIPMENTS  
CONTRACTING**

Experience, combined with innovation, allows our products to be used in the most diverse **industrial applications**; alarm management is very important for safety and this is why all the controllers are designed to supply effective diagnostics whether at local level or by connection to remote assistance system. Dixell devices are particularly adaptable and make the application easy to use even in the industrial automation field, thanks to the wide range of products available and their compatibility with current safety standards.

**INFO**

For **further information** about conditioning products please see our air conditioning catalogue or check out our web site [www.dixell.com](http://www.dixell.com).



## SYSTEMS

The XWEB System family is based on web technology used to satisfy monitoring and supervising requirements in Commercial and Industrial Refrigeration fields from small shops to supermarkets, and refrigerated warehouses to food production centers. Other potential fields are: chemical-pharmaceutical, oenological, naval, museums, hospital, etc.

Dixell Systems conform to **HACCP** rules; the **CRO** (compressor rack optimization) reduced Set-point, anti-sweet heaters, lights and the power peaks are used with the result of having an optimize **energy savings**.

It is also important to have the possibility to have integration with air conditioning machines that are equipped with iCHILL and iPro Dixell controllers. For retrofitting we offer iCOOLL **wireless** (RF) modules plus relay and acquisition module families for probe inputs and alarm outputs.

All XWEB's can be connected anywhere with XCENTER, the program for the centralized management for a modern and organized **Call Center**, dedicated to alarm management and for a pro-active Service based on the Oracle database.

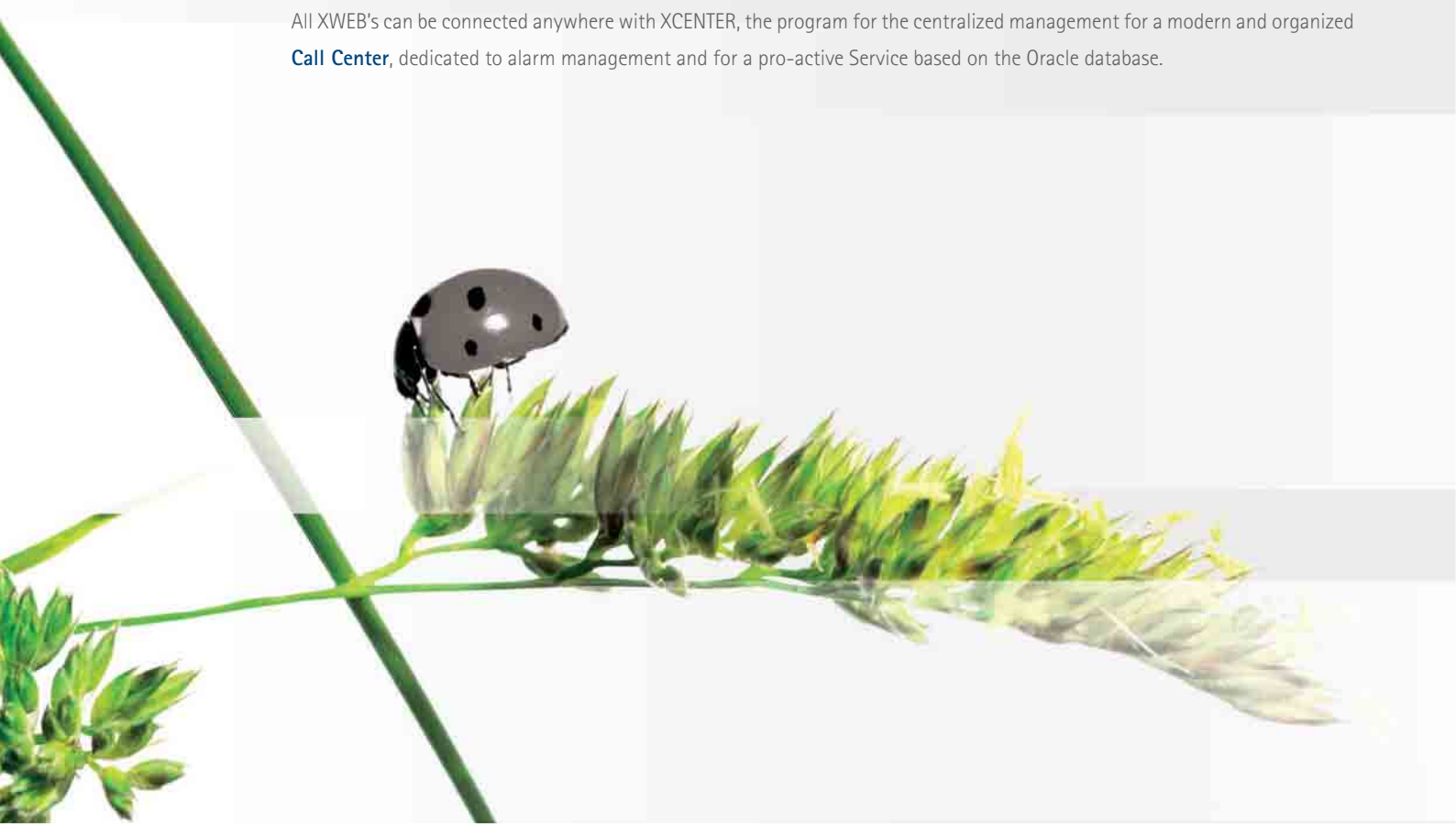



# SYSTEMS

## SECTION INDEX

FUNCTIONS	MODELS	
<b>GLOBAL RETAIL SOLUTION</b>		<b>12</b>
<b>XCENTER – centralized management</b>		<b>14</b>
Centralized management software for Call Center	XCENTER	14
<b>XWEB300D – alarm management and controlling</b>		<b>18</b>
Alarm and controlling web server	XWEB300D	18
<b>XWEB500 – XWEB500D – monitoring and controlling</b>		<b>20</b>
Monitoring and controlling web server	XWEB500 - XWEB500D	20
<b>XWEB3000 – industrial monitoring and controlling</b>		<b>22</b>
Industrial monitoring and controlling web server	XWEB3000	22
<b>XWEB5000 – monitoring, controlling and supervising</b>		<b>24</b>
Monitoring, controlling and supervising web server	XWEB5000	24
<b>XWEB FUNCTIONS</b>		<b>26</b>
<b>XWEB CONNECTIONS</b>		<b>28</b>
<b>XWEB SYSTEMS GUIDE</b>		<b>30</b>
<b>XWEB ACCESSORIES – modem – wireless modules – power analyser</b>		<b>31</b>
Connection modems and cables	XWEB MODEM – TC35-KIT – CAB/WEB/NET – CAB/WEB/PC	29
TX/RX modules for wireless network	XJ100 – XJ150 – PWS150S	31
Energy analysers	WM14 – WM22D	31
XWEB500 bracket	XW-WA	31
<b>XJA-XJP-XJR – relay and acquisition modules</b>		<b>32</b>
Relay module	XJR40D	33
Temperature/humidity/pressure probe acquisition modules	XJP30D – XJP40D – XJP60D	33
Alarm acquisition modules	XJA50D – XJA50SL	33

# GLOBAL RETAIL SOLUTION

Research, great experience, regulation and design innovation: these are the elements that allow Dixell to offer controllers and supervising systems that are in the forefront for all commercial and industrial refrigeration applications, air conditioning and catering fields. A series of specific solutions and a comprehensive range that extends from Thermometers to Multifunction Controllers, from Supervising Systems to the Call Centers, for a completely centralized plant.

In particular, Dixell systems are a range designed to satisfy all quality, user friendliness and efficiency requirements for every kind of application. Dixell, with its systems, integrates and coordinates all components of system regulation in order to optimize the efficiency and to increase energy savings.

Some of Dixell instruments that allow this are:

- the innovative suction pressure management of compressor rack's through CRO
- the dew point check and the modular management of anti-sweat heaters
- the load supervising and the electric consumption peak management

In addition the typical functions of a monitoring system:

- the temperature recording according to HACCP regulations
- the transmission and management of regulation and plant alarms



## SYSTEMS



## CALL CENTER

XCENTER



XWEB5000



XWEB3000



XWEB500 - XWEB500D



XWEB300D



Results prove that Dixell systems are in synergy with all regulation components ensuring:

- better performance
- greater efficiency
- a complete local and remote monitoring
- maximum environmental preservation

XCENTER, the centralized management software ideally suited for a modern and organized Call Center, completes the range of products. A powerful and affordable instrument that allows a remote plant monitoring.

# APPLICATIONS

**PETROL STATIONS  
STORAGE CENTRES**



**SUPERMARKETS  
HYPERMARKETS**



**PRODUCTION PLANTS  
INDUSTRIES**



**AIR CONDITIONING**

**LIGHTING**



**ENERGY SAVINGS**

**REFRIGERATION**

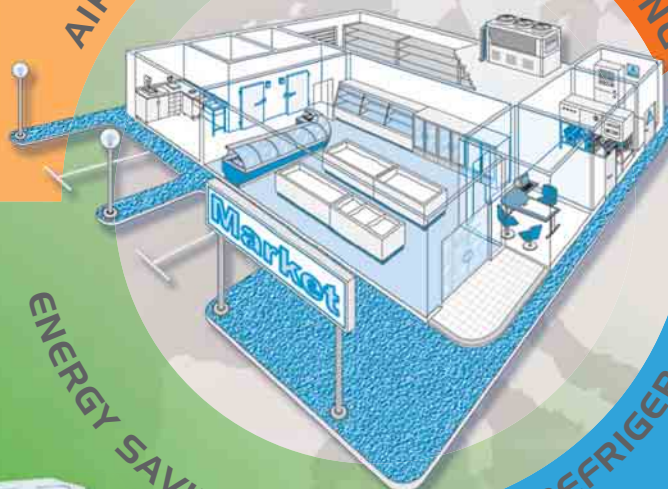



## XCENTER: CENTRALIZED MANAGEMENT SOFTWARE FOR CALL CENTER

**APPLICATIONS:** designed and developed in order to monitor plants that are positioned in different zones, XCENTER is a flexible, reliable and user-friendly software package.

Efficient assistance is a widespread requirement among distribution centers, small and big supermarkets, industrial plants etc. XCENTER gives this type of support with alarm management, continuous devices check and the recipient management with a relative report.

XCENTER doesn't have limits regarding the number of plants and controllers that can be checked and is suitable for every kind of requirement.

- Modular software that, when installed in a server PC, communicates with clients (XWEB systems and remote PC)
- Third party system compatibility
- Database Oracle® that manages many controllers
- Data and alarms files from real installations, available for all clients
- User interface is simple to understand
- Multilanguage management
- Geo-location positioning and controllers status
- Command sending to real instruments
- Possibility to quickly modify controllers parameters
- Alarm setup and management
- Alarm report via e-mail – SMS
- Recipient list management
- Statistical data management in graphical format
- Internet connection between XCENTER and the monitoring units are by means of the standard SNMP protocol or telephone line (via dial-up or an internet provider)
- Open project that allows add-on software (warehouse and accountant management,...)

### HOW TO ORDER

XCENTER X C E N T E R - A B O O O

A	B
N° of server	N° of client
O = 0 A = 1	N = 0 B = 2 L = 10

## XCENTER INSTALLATION LAYOUT

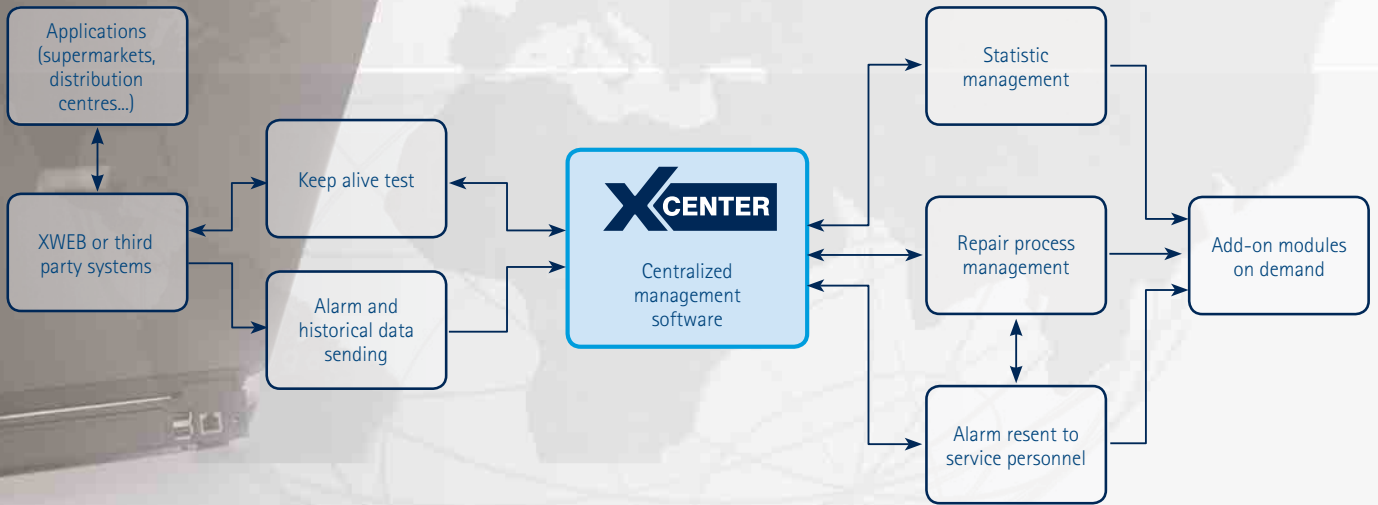

The software is composed of two modules: **server** and **client**.

The **server** can be installed in a computer with the following minimum system requirement:

- CPU Pentium® IV or similar
- 1GB RAM
- 100GB hard-disk space
- Microsoft Windows XP or Windows 2003 Server
- Permanent Internet connection
- Modem connection (optional)

The **software clients** are installed in each computer, they can operate either via an intranet or the Internet. Minimum system requirements for the clients are:

- CPU Pentium or similar
- 512MB RAM memory
- 20GB hard-disk space
- Microsoft Windows XP
- Network card and/or modem
- Microsoft Internet explorer 5.5 or higher

## XCENTER INSTALLATION

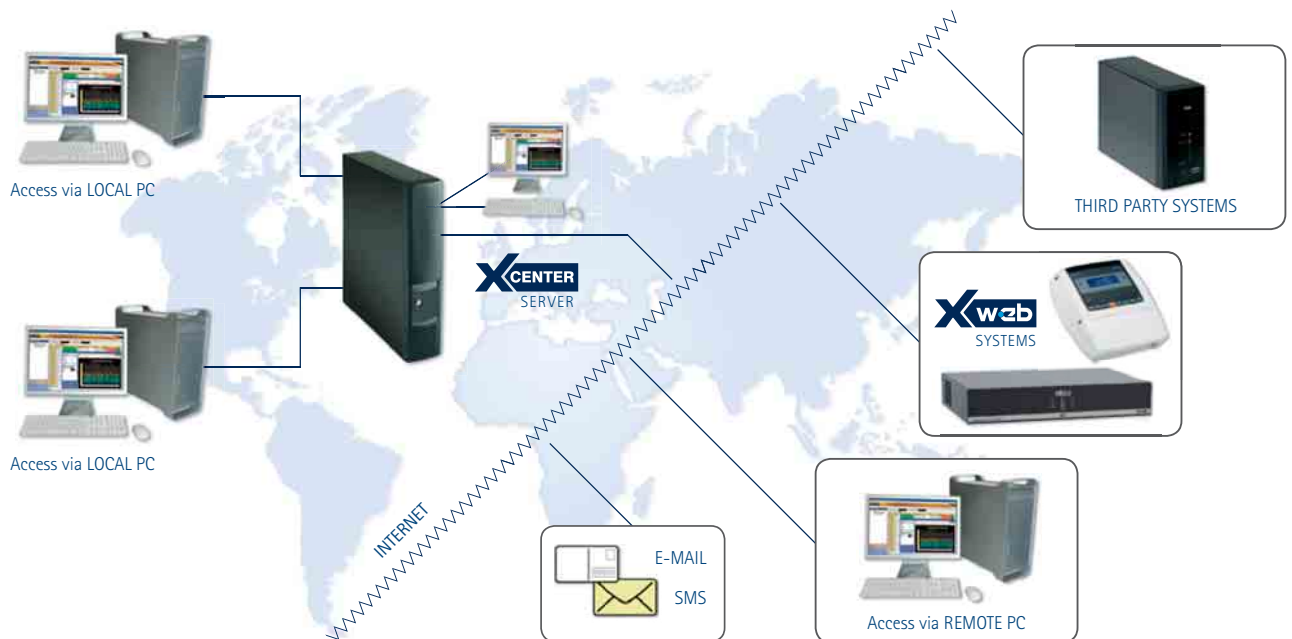

Alarm Code	Description	Severity	Status
N12/0364/2008	High temperature Pb1	High	Active
N12/0364/2008	High temperature Pb2	High	Active
N12/0364/2008	High temperature Pb3	High	Active
N12/0364/2008	High temperature Pb4	High	Active
N12/0364/2008	High temperature Pb5	High	Active
N12/0364/2008	High temperature Pb6	High	Active
N12/0364/2008	High temperature Pb7	High	Active
N12/0364/2008	High temperature Pb8	High	Active
N12/0364/2008	High temperature Pb9	High	Active
N12/0364/2008	High temperature Pb10	High	Active

## ALARM MANAGEMENT

XCENTER introduces a complete new concept regarding alarm management. An alarm that keeps on repeating itself, or that happens during night time, can be treated with a different severity. The default level of severity can be increased according to the duration, the frequency, the time of the day.

## COMMANDS AND PARAMETERS

The XCENTER user is authorized to interact with the controller directly from the program or it has the possibility to be connected to the XWEB and start using it just like via the browser. For every alarm the software creates a report to describe the complete history of the alarm. It is possible to add notes, collect a log file of the commands that has been sent and finally a form with all the information regarding the alarm can be filled in. Later, by retrieving this information, the operator will be able to have a complete overview of what happened.

**Workshop** - 11D Daily

**Event Code:** N12/0364/2008 **Description:** High temperature Pb1

**Analog Values:**  
 Supply Air (Pb1): 1.0 %  
 Evaporator (Pb2): 1.4 %  
 Product (Pb3): 0.0 %

**Device Status:** On (Defrost, Keyboard)

**Output Status:** Defrost, Light, Fan, Cooling

Department	Name	Phone	Mail
Production Control	Luca	02/20000000	luca@xcenter.com
Production Control	Luca	02/20000000	luca@xcenter.com
Production Control	Luca	02/20000000	luca@xcenter.com
Production Control	Luca	02/20000000	luca@xcenter.com
Production Control	Luca	02/20000000	luca@xcenter.com

## CONTACTS

XCENTER uses a list of recipients to be contacted for local, regional and national events. Based on need, and according to the alarm severity, the right person will be alerted.

## GRAPHICS

Alarms are displayed together with the log of the past 48 hours of the controller functions. It's possible to determine and understand the kind of problem and decide how and when intervene.

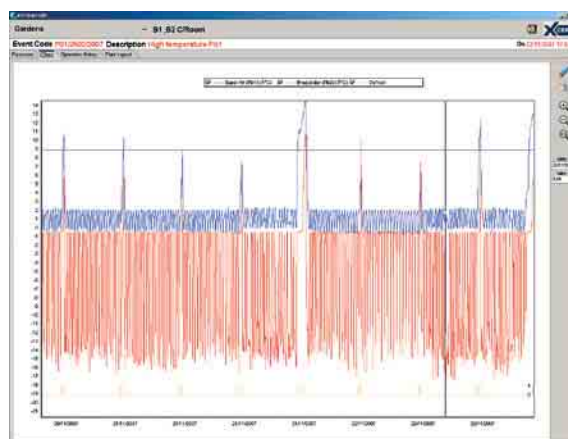







D: 10 DIN Rail

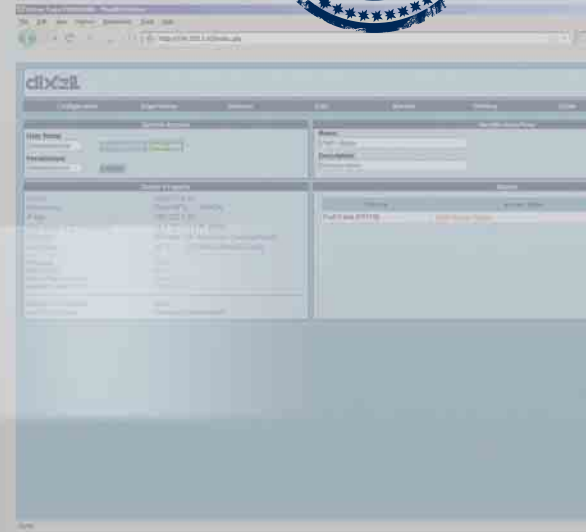

## XWEB300D: ALARM AND CONTROLLING WEB SERVER

**APPLICATIONS:** it is extremely well suited for 6 or 18 device installations such as petrol stations, mini-market, small storage centres. A simple DIN Rail mounting (4 DIN) and the absence of local user interface make the XWEB300D the ideal solution for the remote connection / assistance (via modem) to the plant. Local or remote connection from PC is made without the need for special software, only standard web browser (Microsoft Internet Explorer® or Firefox®) software is needed; the information is displayed as Web pages. The competitive price lets you to use this Web Server in applications with a only a single regulator such as compressor rack and medical close control.

- Data capture and alarm monitoring web server connectable to Dixell's controllers with serial output or to others ModBUS-RTU compatible devices
- Structure based on Linux operating system with WEB pages
- Data shown for all controller values, parameters programming and alarms
- Powerful graphs showing and exporting functions in Excel® format
- Calendar function to filter alarm transmissions to a particular service
- Alarm sending via FAX, SMS or e-mail
- Possibility to have a connection with a PDA or Smartphone
- Local or remote connection to a PC with a standard browser (Microsoft Internet Explorer® or Firefox®) for the data display and monitoring
- 8MB or 24MB internal memory to store up to 1 year data recorded with 15 min sampling time and 6 or 18 controllers
- Standard communication protocol ModBUS-RTU
- 15VA max power absorption

XWEB300D checks the unit and, in case of malfunction alarm, it notifies the assistance centre through FAX, SMS or E-mail. It allows OEM's via direct control to decide to engage a local service call out only if necessary. XWEB300D can also records all data relevant to the function of the controlled unit and insert them into a table. In this way the OEM has important information for new models for improvement of the unit itself.



Thanks to LAN port, the connection (also via internet) to the XWEB300D is easy and safe and no special software is required. It is possible to see all the variables of a controller and to manage of all parameters and alarms. With Java Applet it is possible to generate comprehensive visual graphs.

**TECHNICAL DATA**

200MHz CPU  
 Internal memory 8MB (6 instruments) and 24MB (18 instruments)  
 24Vac or 110÷230Vac ±10% power supply  
 1 LAN output  
 1 RS485 serial line for device (ModBUS – RTU) connection

1 RS232 port for external modem  
 1 configurable relay  
 Programmable sampling time from 1 to 60 minutes  
 Optional analogue or GSM internal modem  
 Direct power supply for GSM modem

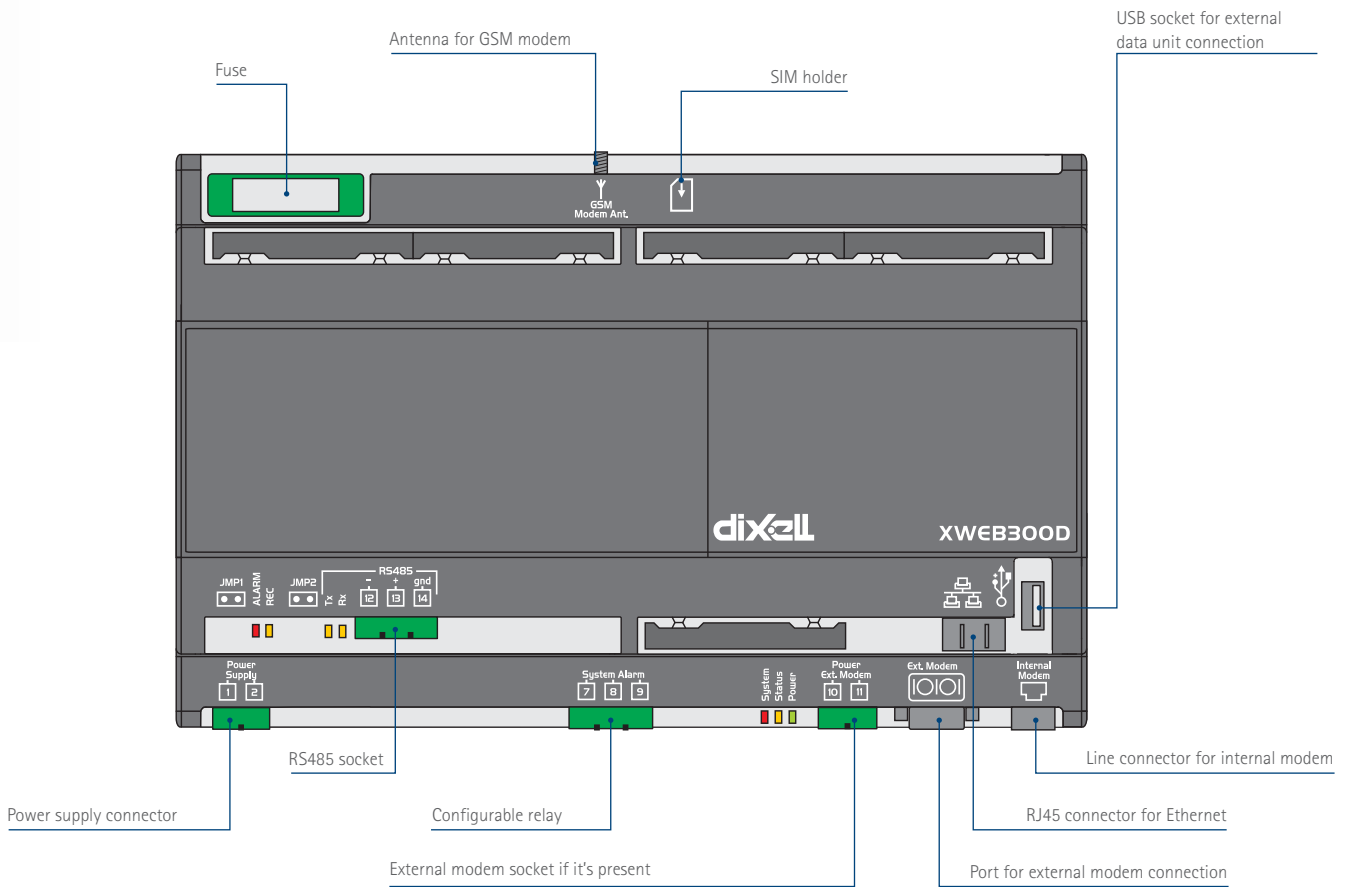

**HOW TO ORDER**

XWEB300D [X][W][E][B][3][0][0][D][ ][-][ ][A][ ][B][ ][0][ ][0][ ][E]

A	B	E
<b>Power supply</b>	<b>N. of instruments</b>	<b>Internal modem</b>
2 = 24Vac 8 = 110÷230Vac	B = 6 F = 18	0 = No 1 = Analogue modem 2 = GSM modem

More information about functions and connections at pages 26÷30

D: 10 DIN Rail



210x230mm



## XWEB500–XWEB500D: MONITORING AND CONTROLLING WEB SERVER

**APPLICATIONS:** it is extremely well suited for medium installations up to 36 or 100 devices, such as petrol stations, supermarkets or storage centres. Its innovative and useful features make the instrument suitable for medium-large applications such as production and storage goods centres. Thanks to its 2 available formats, it can be installed whether on DIN Rail or wall or panel mounting, but can also be used as desk instrument. Local or remote connection from PC is made without the need of special software, only standard web browser (Microsoft Internet Explorer® or Firefox®) software is needed; the information is displayed as Web pages.

- Monitoring and controlling web server connectable to Dixell's controllers with serial output or to others ModBUS-RTU compatible devices
- The unit can operate as a stand-alone server by means of the local keyboard and display (XWEB500)
- Electrical panel board on DIN Rail mounting (XWEB500D)
- Structure based on Linux operative system with WEB pages
- Controller values display and parameter and alarm management
- Powerful tool to view graphs and export in Microsoft Excel® format
- Calendar function for alarm transmission to the "in charge" service
- Alarm sending via FAX, SMS or e-mail
- Command sending activation through digital input
- Possibility to have a connection with a PDA or Smartphone
- Local or remote connection from PC using standard browser (Microsoft Internet Explorer® or Firefox®) for the data management and display
- 48MB or 128MB internal memory to store 1 year of data with 15min sampling time (36 or 100 controllers)
- Standard communication protocol ModBUS-RTU
- 15VA max power absorption for XWEB500D and 20VA max power absorption for XWEB500

### TECHNICAL DATA

200MHz CPU  
48MB internal memory (36 controllers) and 128MB internal memory (100 controllers)  
24Vac power supply (XWEB500D only) or 110, 230Vac  $\pm 10\%$   
1 LAN output  
1 USB output (XWEB500D) – 2 USB outputs (XWEB500)  
1 RS485 serial line for device (ModBUS – RTU) connection

1 RS232 output for external modem connection  
1 system alarm relay output  
2 RS485 alarm relay outputs  
1 digital input  
Sampling time programmable from 1 to 60 minutes  
Optional analogue internal modem or GSM  
Direct power supply for GSM modem (XWEB500D)

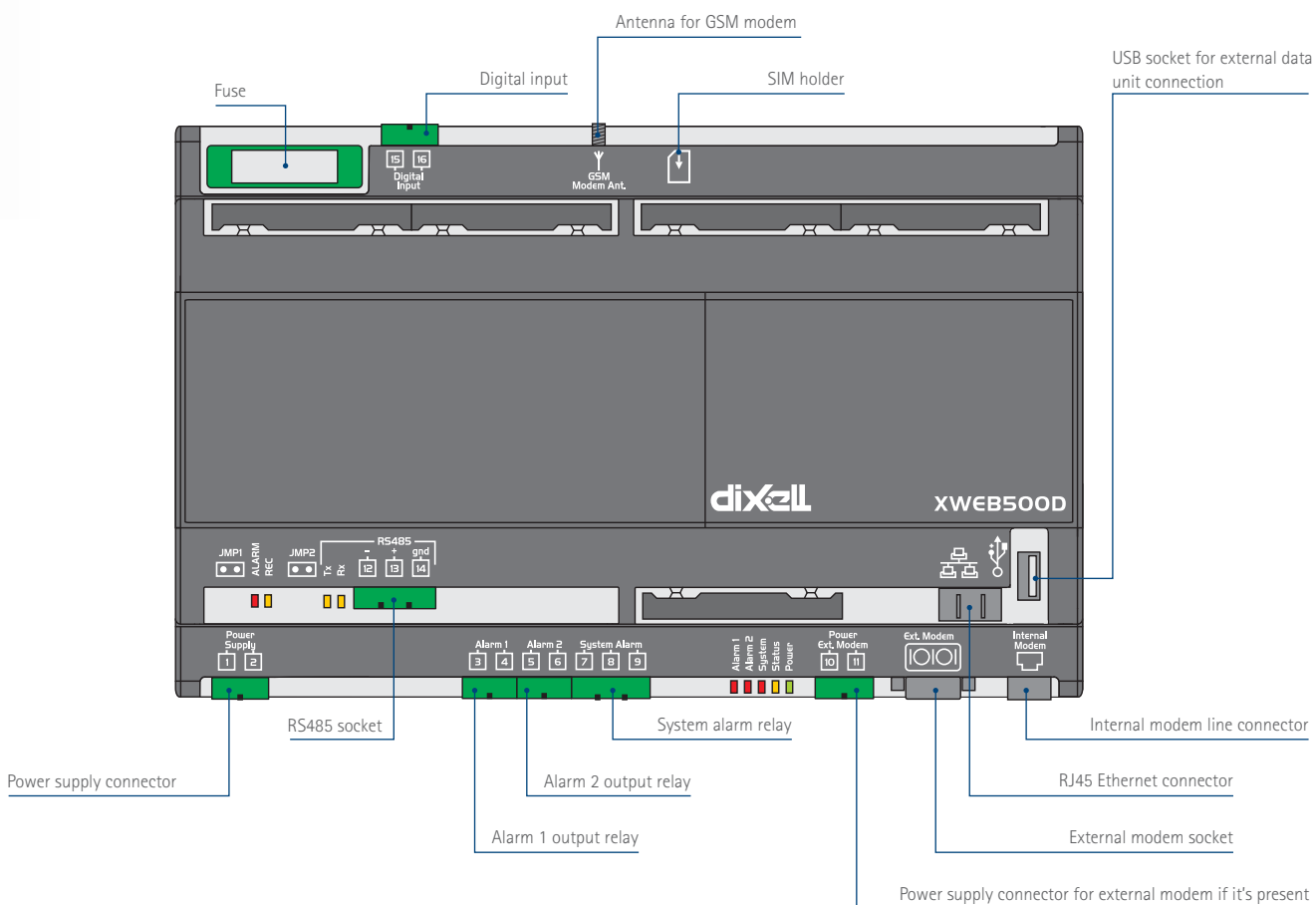
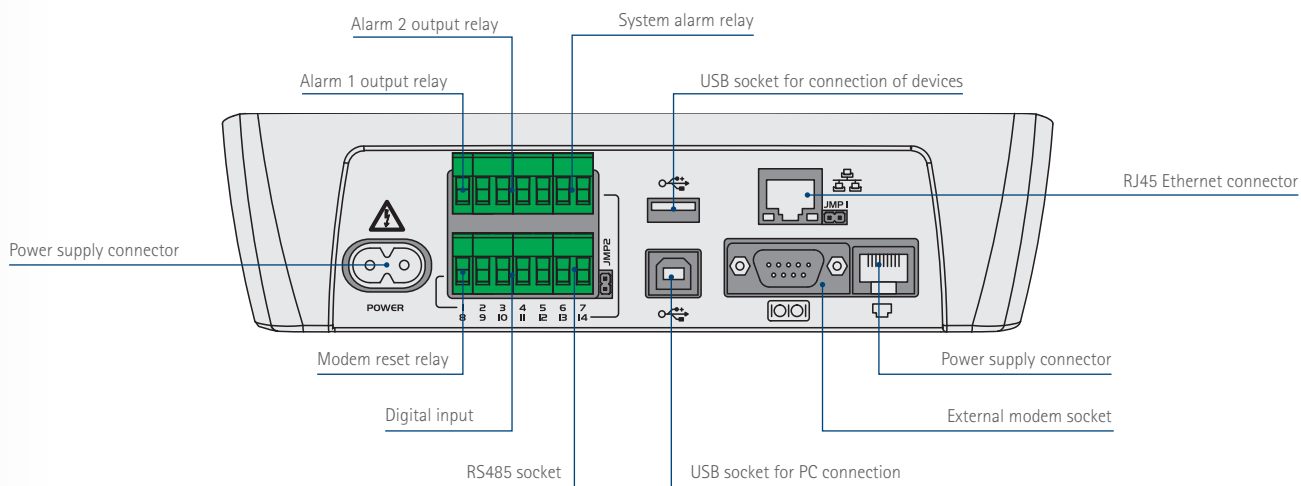

## HOW TO ORDER

XWEB500 

X	W	E	B	5	0	0	-	A	0	0	0	E
---	---	---	---	---	---	---	---	---	---	---	---	---

XWEB500D 

X	W	E	B	5	0	0	D	-	A	B	0	0	E
---	---	---	---	---	---	---	---	---	---	---	---	---	---

A	B	E
<b>Power supply</b>	<b>N. of instruments</b>	<b>Internal modem</b>
<b>2</b> = 24Vac (for XWEB500D) <b>4</b> = 110Vac (for XWEB500) <b>5</b> = 230Vac (for XWEB500) <b>8</b> = 110÷230Vac (for XWEB500D)	<b>H</b> = 36 <b>T</b> = 100	<b>0</b> = No <b>1</b> = Analogue modem <b>2</b> = GSM Modem (for XWEB500D)

More information about functions and connections at pages 26÷30



370x238mm

## XWEB3000: INDUSTRIAL MONITORING AND CONTROLLING WEB SERVER

**APPLICATIONS:** it is extremely well suited for larger installations with up to 247 devices such as supermarkets, hypermarkets or large storage and distribution centres as well as production and storage goods processing such as fast-food, restaurants, catering up to medical and pharmaceutical applications. XWEB3000 is the ideal solution for service needs (modem, ethernet and internet connection); it can operate, as a stand-alone server without using a PC but it's also simple to connect a monitor, keyboards and mouse. Local or remote connection from PC is made without the need of special software; only standard web browser (Microsoft Internet Explorer® and Firefox®) software is needed. The alarm signalling for service is very flexible and can be done through Fax, e-mail, SMS and also via relay outputs.

- Monitoring and controlling industrial web server connectable to Dixell's controllers with serial output or to others ModBUS-RTU compatible devices
- Structure based on Linux operating system with WEB pages
- All controller values can be showed using a special "Single View" window or using "Run Time" window where many controllers can be viewed at the same time. It is even possible to use a "Layout" view of the plant with pictures and schematics drawings
- Powerful tool to view graphs and export in Microsoft Excel® format
- Easy plant management by means of the "Scheduler" to send commands according to a custom calendar
- Calendar function and internal RTC both for alarm transmission to the "in charge" service and command sending to the controllers
- Possibility to divide the controllers set in different categories of products with their own sampling time
- Alarm sending via FAX, SMS or e-mail
- Commands sending activation through digital input
- Possibility to have a connection with PDA or Smartphone
- Local or remote connection from PC using standard browser (Microsoft Internet Explorer® or Firefox®) for the data management and display
- Standard communication protocol ModBUS-RTU
- 19" RACK or desk mounting
- 50VA max power absorption



Easy configuration, efficient management of all controller values and a display of controllers also using pictures and schematic drawings: these are some of the XWEB3000's strengths. It is an intuitive, powerful and at the same time, very versatile device. This web server allows parameter and alarm management with different levels and typologies, providing the user with the possibility to divide the controllers into different categories, each with their own sampling periods. Powerful tools include: the scheduler which is a graphic instrument created to manage commands sent to the controllers, data export used to save data in a Microsoft Excel file, and the back-up function to have data-safe protection even in the worst environmental usage, also to save all the unit setup.

### TECHNICAL DATA

- 1,3GHz CPU
- 512MB internal memory
- 120GB HD
- 1 LAN output
- 2 USB outputs
- 110/230Vac ±10% power supply
- 1 RS485 serial line for device (ModBUS - RTU) connection
- 1 RS232 output for external modem connection
- 1 system alarm relay output
- 2 RS485 alarm relay outputs
- 1 print output (25 pin)
- 1 digital input
- 1 keyboard/mouse connector
- 1 video output
- Sampling time programmable from 1 to 255 minutes
- Analogue internal modem (optional)

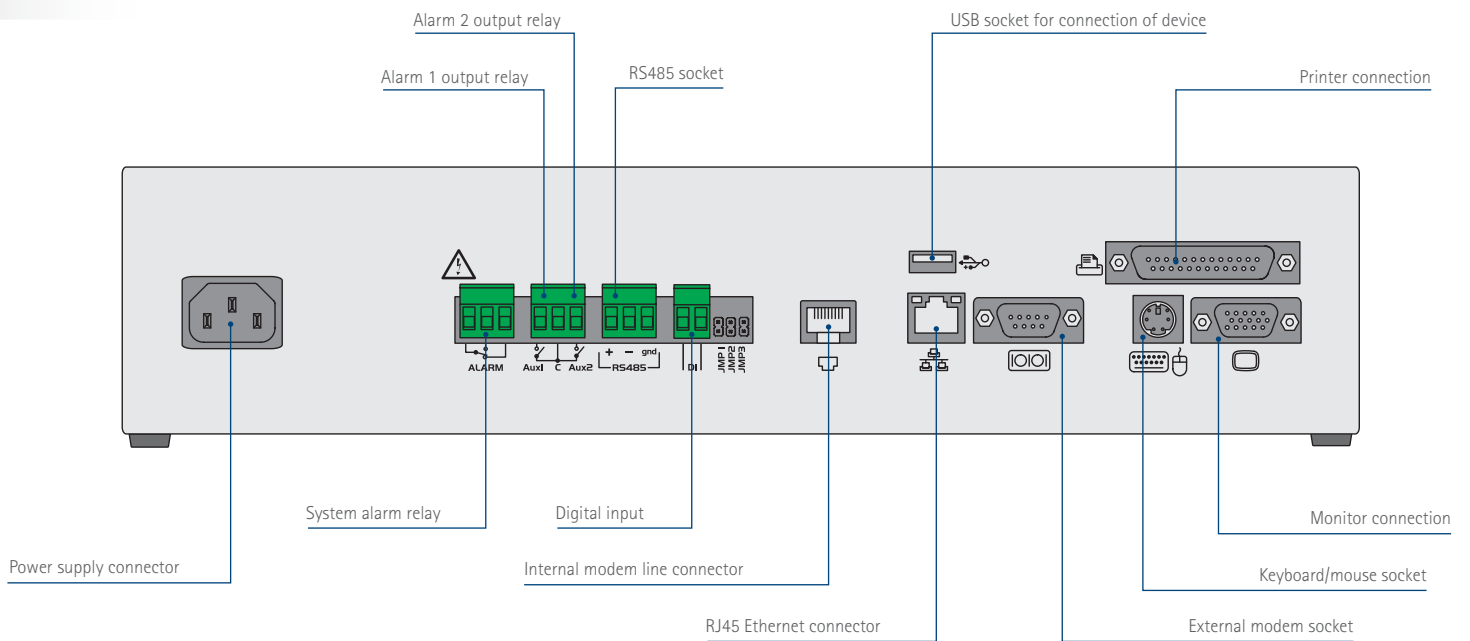

### HOW TO ORDER

XWEB3000 X W E B 3 0 0 0 - 6 0 0 0 E

E

**Internal modem**

- 0 = No
- 1 = Yes

More information about functions and connections at pages 26÷30



370x238mm



## XWEB5000: MONITORING, CONTROLLING AND SUPERVISING WEB SERVER

**APPLICATIONS:** provided with a powerful supervision engine suited for larger installations (with up to 247 devices) in the refrigeration, conditioning and building automation field, where it's necessary to program several different interactive actions that the controller has to perform. It is extremely well suited to hypermarkets, large storage and distribution centres, as well as production and storage goods processing and is ideal for the large service centre (modem, ethernet and internet connection). The system manages the alarm transmission to the "in charge" service (via Fax, e-mail, SMS and also through relay outputs) and it can also work without a PC using direct connection of a monitor, keyboard and mouse. Local or remote connection PC is made using Microsoft Internet Explorer® and Firefox® browser.

- Monitoring, controlling and supervising web server connectable to Dixell's controllers with serial output and to others ModBUS-RTU compatible devices.
- Built-in editor with local and field simulator
- Automation algorithms (to manage the use of lights, signs, the battery charge/discharge as fork lifts,...)
- Structure based on Linux operating system with WEB pages
- All controller values can be showed using a special "Single View" window or using "Run Time" window many controllers can be viewed at the same time. It is even possible to use a "Layout" view of the plant with pictures and schematics drawings
- Powerfull tool to view graphs and export in Microsoft Excel® format
- Easy plant management by means of the "Scheduler" to send commands according to a custom calendar
- Calendar function and internal RTC both for alarm transmission to the "in charge" service and command sending to the controllers
- Possibility to divide the controllers set in different categories of products with their own sampling time
- Alarm sending via FAX, SMS or e-mail
- Commands sending activation through digital input
- Possibility to have a connection with PDA or Smartphone
- Local or remote connection from PC using standard browser (Microsoft Internet Explorer® or Firefox®) for the data management and display
- Standard communication protocol ModBUS-RTU
- 19" RACK or desk mounting
- 50VA max power absorption
- Including **CRO system (Compressor Rack Optimization)** to reduce plant energy costs



## SUPERVISING

With XWEB5000 it's possible to intervene sending commands to monitored devices. The installer can create a supervision "Project" (or several "Projects") by programming links between the input variables (inputs, status and outputs of a controller) and defining what actions the system must take when these conditions are met. Unlike a standard PLC, where the user is required to know a specific programming language, with the XWEB5000 the "project" can be easily created using a simple graphic user interface, but importantly, without the need to learn a complex programming language. A specific software is not necessary: the supervising software has been written in JAVA and it runs on the client PC. The project is saved to the XWEB5000; several project can be run simultaneously.

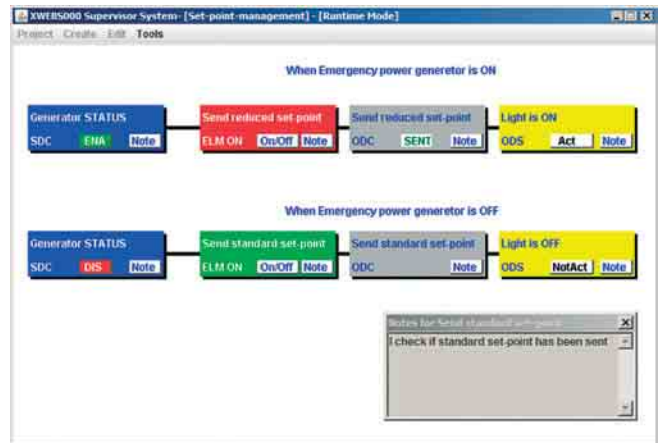

## TECHNICAL DATA

- 1,3GHz CPU
- 512MB internal memory
- 120GB HD
- 1 LAN output
- 2 USB outputs
- 110/230Vac ±10% power supply
- 1 RS485 serial line for device (ModBUS – RTU) connection
- 1 RS232 output for external modem connection

- 1 system alarm relay output
- 2 RS485 alarm relay outputs
- 1 print output (25 pin)
- 1 digital input
- 1 keyboard/mouse connector
- 1 video output
- Sampling time programmable from 1 to 255 minutes
- Analogue internal modem (optional)

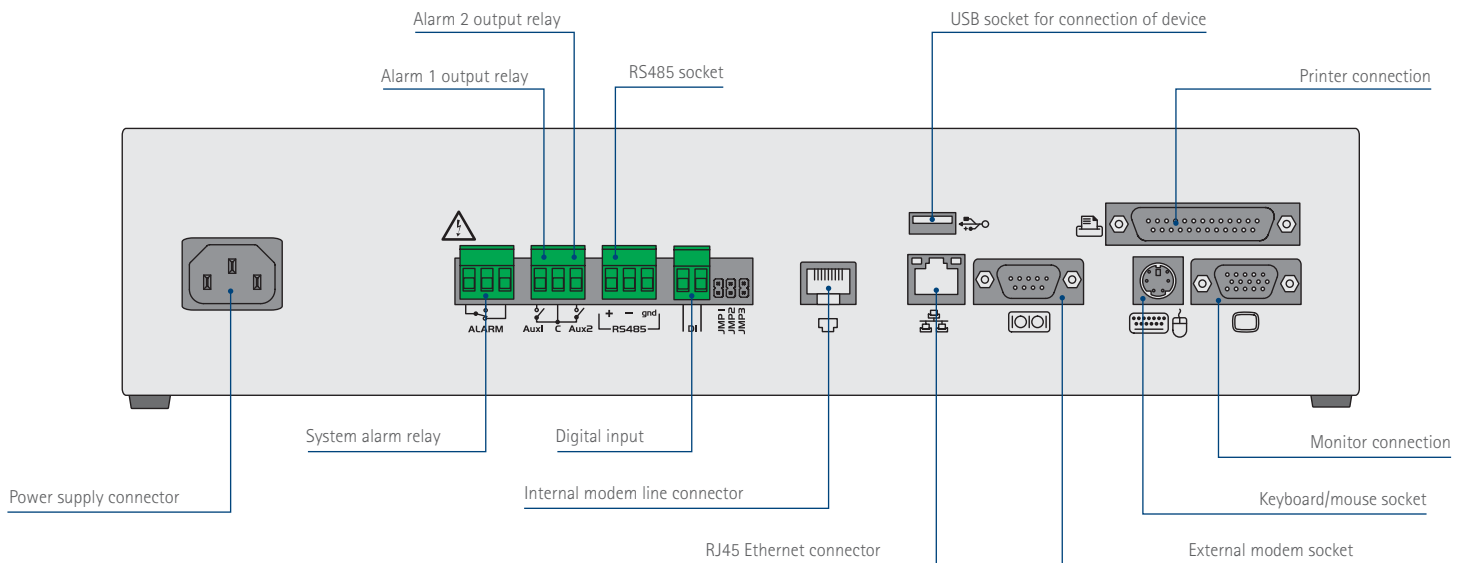

## HOW TO ORDER

XWEB5000 

X	W	E	B	5	0	0	0	-	6	0	0	0	E
---	---	---	---	---	---	---	---	---	---	---	---	---	---

E
---

**Internal modem**

- 0 = No
- 1 = Yes

# XWEB FUNCTIONS

An overview of some most important XWEB family functions.

Address	Model	Name	TR	FR	% OK	SLast	TimeOut	Occupancy	Test
73	XM463C	13 HLU	1895	0		01:00:00:100	0		Test
609	XM463C	Linear Store CR LBS1	1895	0		01:00:00:100	0		Test
110	XM463C	Linear Store CR LBS2	1877	0		01:00:00:100	0		Test
76	XM463C	13 HLU	22618	1060		83.33:16.67	0	18.67	Test
77	XM463C	13 HLU	23760	1000		83.34:16.66	0	18.66	Test
78	XM463C	13 HLU	23731	1077		83.34:16.66	0	18.66	Test
79	XM463C	13 HLU	23739	1075		83.34:16.66	0	18.66	Test
80	XM463C	13oz Deli	22742	10784		83.33:16.67	0	18.67	Test
85	XM463C	14oz Bakery	22765	10904		83.33:16.67	0	18.68	Test
95	XM463C	21oz Fruit & Veg	23739	10767		83.33:16.67	0	18.67	Test
96	XM463C	21oz in a Risk Fruit & Veg	23732	10780		83.34:16.66	0	18.66	Test
119	XM463C	20oz High Meat	22734	10770		83.34:16.66	0	18.66	Test
119	XM463C	20oz High Meat	22740	10762		83.33:16.67	0	18.67	Test
121	XM463C	1kg Omelet	23719	10765		83.33:16.67	0	18.66	Test
86	XM463C	1 The Dairy	22713	10750		83.33:16.66	0:02	18.66	Test
150	HEHRO AVAL	Energy Analyzer	10480294014			99.82:0.18	10.38	0	Test
2	XM463C	15oz Sk Icecream	22710	22707		99.99:0.01	0:01	0	Test
55	XM463C	11oz Dairy	22679	22674		99.99:0.01	0:02	0	Test
58	XM463C	11oz Dairy	22745	22707		99.94:0.16	0:18	0	Test
89	XM463C	Open CR GC1	18792	18791		99.99:0.01	0:01	0	Test
99	XM463C	Open CR GC2	18890	18782		99.82:0.17	0:17	0	Test
100	XM463C	Bakery CR H	18002	18001		99.99:0.01	0:01	0	Test
105	XM463C	Empty CR E1	18789	18789		99.99:0.01	0:01	0	Test

## RS485 LINE-CHECK

A powerful new tool is able to check performance and statistic data for each controller by carrying out a functional test for every device connected to the RS485 network. You can then have information regarding the quality of the connection. The tool is very useful especially when there is the necessity analyse a network problem; with a statistics that allows you to easily identify which instrument has a connection problem.

## PARAMETER PROGRAMMING AND RUN TIME

Thanks to the XWEB the user has an intuitive, powerful and at the same time, very versatile device, that allows him/her to modify the various functioning parameters of the instruments. It will no longer be necessary to make manual adjustments on the controller, because by using the different windows available, and with a few simple operations, it's possible to obtain the required updating. The Run Time function displays many devices together in a unique window. This is dynamic page and the data showed is updated in real time. The status of the devices connected (also from different manufacturers) is displayed simply and clearly and it's possible to modify the various functioning parameters of the instruments.

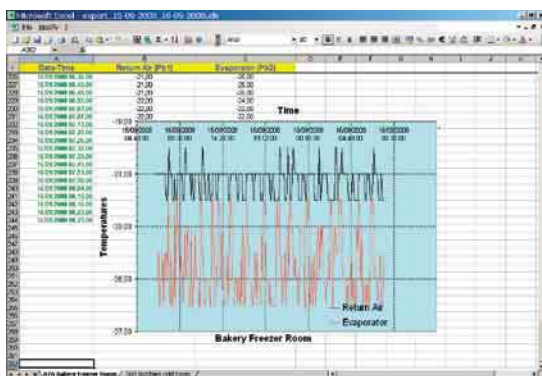

## DATA EXPORT

It is possible to export all data information in a Microsoft Excel® file. The user can later use this information to build graphs or to collect data. It is possible to select a data interval and filter between different controllers.

## LAYOUT AND GLOBAL COMMANDS (FOR XWEB500D, XWEB500, XWEB3000, XWEB5000)

A powerful graphic editor that doesn't require the installation in your PC of any additional software, is what makes XWEB layout the ideal solution. Using this function the user can access all the recorded data of the controllers and even send a command to a controller. Global Commands option let you send multiple commands to one or more controllers at the same time. In addition, using the digital input it is possible to automatically start the sending of commands.



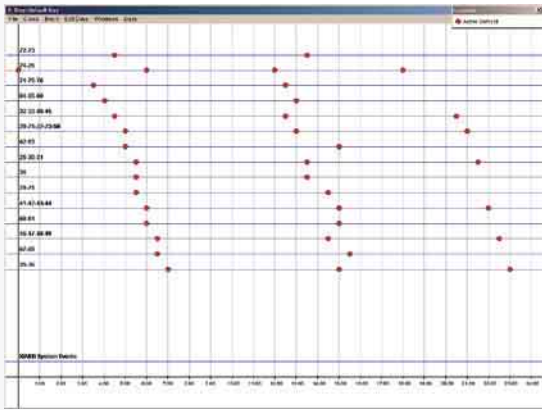

## SCHEDULER (FOR XWEB500D, XWEB500, XWEB3000, XWEB5000)

The scheduler is a powerful graphic tool to manage commands sent to the controllers. You can quickly see an overview of all daily activity. This means that energy saving routines and defrosts can be easily scheduled.

## PERFORMANCE METER (FOR XWEB500D, XWEB500, XWEB3000, XWEB5000)

This highly appreciated function allows one to verify the right temperature for single devices (wall cabinets, benches, rooms, etc.). The graphic layout offers a complete vision about the plant operating mode.

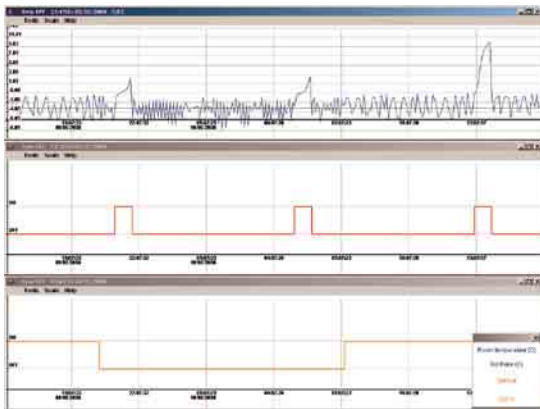

## GRAPHICS (FOR XWEB300D, XWEB500D, XWEB500, XWEB3000, XWEB5000) CIRCULAR GRAPHICS (FOR XWEB3000, XWEB5000)

The XWEB can supply powerful graphs, able to represent multiple analogue variables on the same pictorial system and the course of the status of the outputs and alarms. This allows the user to have a precise snapshot view of important variables, for easy diagnosis of faults. Thanks to the high sampling rate of circular graphs, they are more detailed and appreciated by service for diagnostics.

## CRO (FOR XWEB5000)

The connection to the modern supervising systems (of Dixell) allows, thanks to the special CRO algorithm (Compressor Rack Optimization), to manage the compressor rack set point in the best possible way, depending on the devices connected, resulting in plant optimization and energy saving. The system, equipped with the CRO function, analyzes the information from the controller to determine if a controller needs more refrigeration power and how much. The set point will be recalculated in order to satisfy the worse instance and sent from the supervising system to the XC1000D compressor rack controller; this will be the new working set point. If the supervising system can't manage the XC1000D, it's the controller that "decides" to replace the set point (coming from the system) and will then redefine the set point in the planning phase of a refrigeration plant. The 2 graphs emphasize that when the CRO algorithm is active, in a real installation, the set point becomes on average higher, and consequently the energy consumption decreases. The dotted line represents the average weekly value.

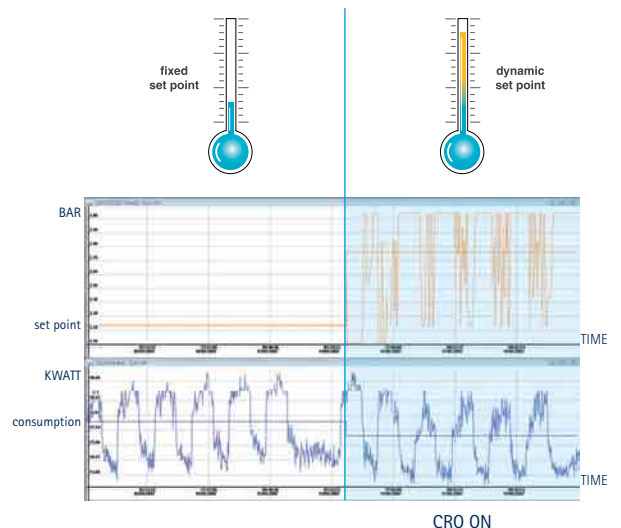

# XWEB CONNECTIONS

Among many important XWEB system features, a remarkable one is the possibility of linked servers using several methods: by PDA, by local PC or remote PC.

## CONNECTION VIA PALMTOP COMPUTER (PDA)

When the connection is made by means of a Palmtop computer (PDA), the XWEB automatically recognises it and makes several dedicated pages available. On them is possible to display all the values of a device and send it commands.



## LOCAL CONNECTIONS

XWEB server and associated systems can be locally linked connecting the system to a PC.



XWEB300D - XWEB500D - XWEB500 - XWEB3000 - XWEB5000

Thanks to their advanced features, XWEB3000 and XWEB5000 can be used as local machine by means of monitor, keyboard and mouse connection.

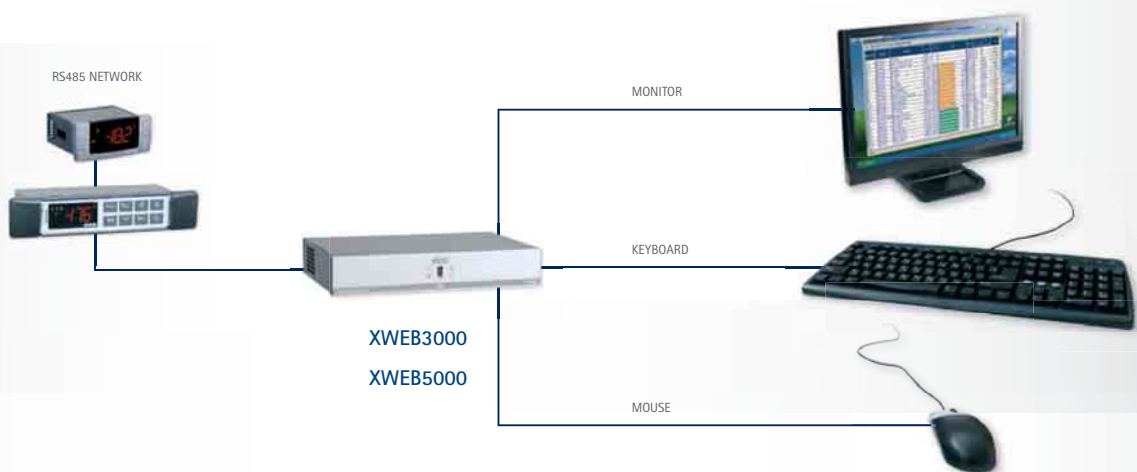

## REMOTE CONNECTIONS

XWEB Server can be remotely accessed using several methods:

- by modem with point to point connection, also with GSM modem (only for devices that support it);
- by link in local Ethernet network, by means of standard net connector RJ45;
- by direct Internet connection, if provided with a static IP address.

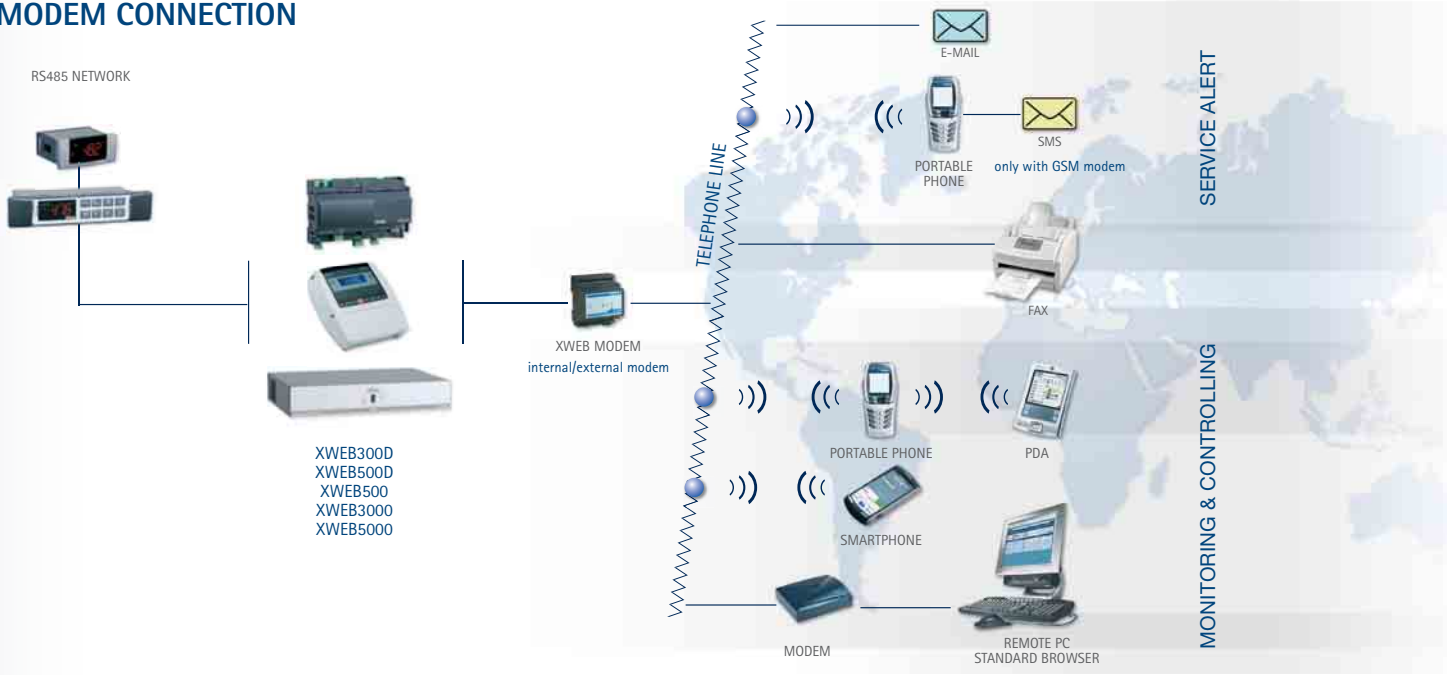

## MODEM CONNECTION

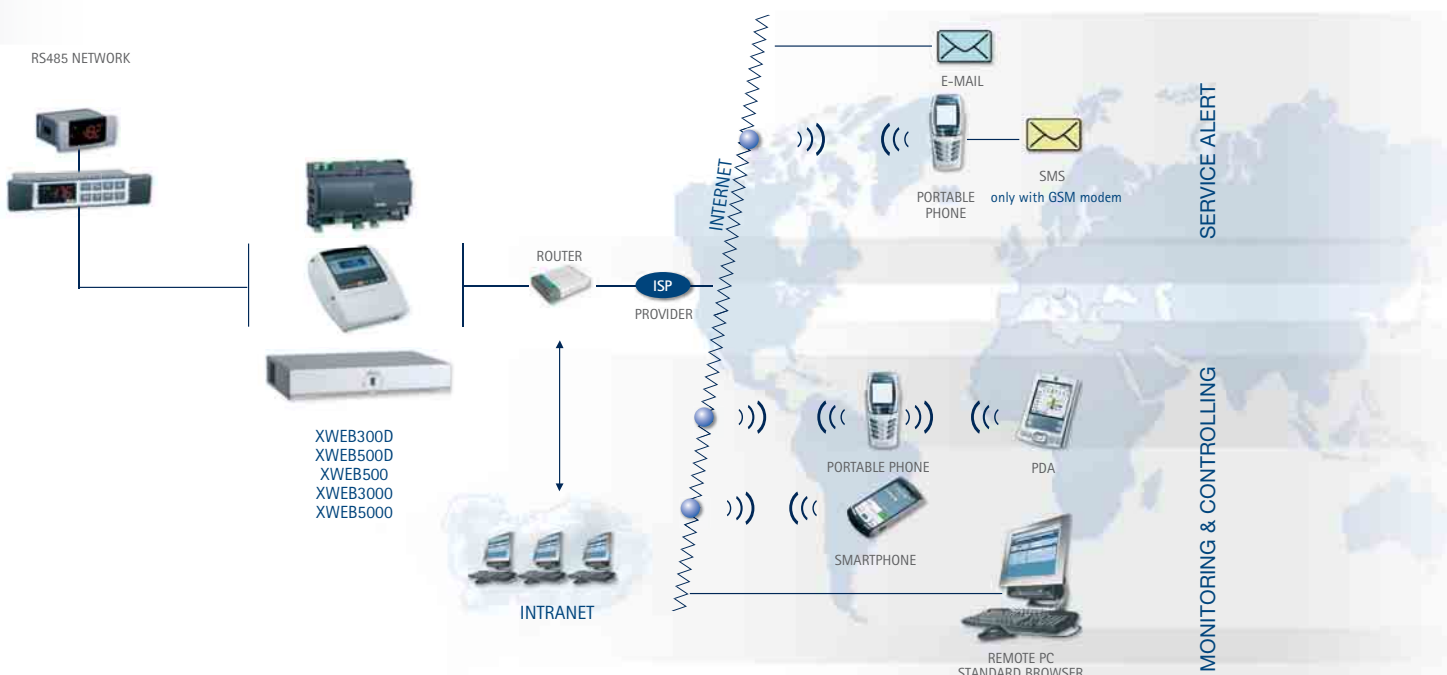

## INTERNET/INTRANET CONNECTION



## MODEMS AND CONNECTING CABLES

<b>XWEB MODEM</b>	for XWEB300D/500D 500/3000/5000	Analogue serial modem PDA compatible, 56kbps (DIN Rail format) HOW TO ORDER: XWEBMODEM-200 (with 24Vac power supply) XWEBMODEM-400 (with 110Vac power supply) XWEBMODEM-500 (with 230Vac power supply)	
<b>TC35-KIT</b>	for XWEB300D/500D/500	GSM modem kit containing the modem, the power supply unit, the transmitting antenna with the relevant cable and the connection to controlling system	
<b>CAB/WEB/NET</b>	for XWEB300D/500D 500/3000/5000	Ethernet patch cable, 3m	
<b>CAB/WEB/PC</b>	for XWEB300D/500D 500/3000/5000	Ethernet patch cross over cable, 1m	

# XWEB SYSTEMS GUIDE

	XWEB300D	XWEB500D	XWEB500	XWEB3000	XWEB5000
<b>Applications</b>	Small and medium	Medium and large	Medium and large	Large	Large with supervision
<b>Format</b>	10 DIN Rail	10 DIN Rail	210x230x87h	350x235x47h	350x235x47h
<b>Power supply</b>	24Vac or 110÷230Vac	24Vac or 110÷230Vac	110Vac or 230Vac	110/230Vac	110/230Vac
<b>On-board display</b>			•		
<b>N. of instruments</b>	6 - 18	36 - 100	100	247	247
<b>CPU</b>	200MHz	200MHz	200MHz	1,3GHz	1,3GHz
<b>Internal memory</b>	8 or 24MB	48 or 128MB	128MB	512MB	512MB
<b>USB port for PC connection</b>			•		
<b>USB output for devices connection</b>		•	•	•	•
<b>Relay output</b>	1	3	3	3	3
<b>Digital input</b>		•	•	•	•
<b>LAN output</b>	•	•	•	•	•
<b>RS485 output</b>	•	•	•	•	•
<b>External modem</b>	Analogue or GSM opt	Analogue or GSM opt	Analogue or GSM opt	Analogue	Analogue
<b>Internal modem</b>	Analogue or GSM opt	Analogue or GSM opt	Analogue opt	Analogue opt	Analogue opt
<b>Sampling time</b>	From 1 to 60 minutes	From 1 to 60 minutes	From 1 to 60 minutes	From 1 to 255 minutes	From 1 to 255 minutes
<b>RS485 line check</b>	•	•	•	•	•
<b>Parameter programming</b>	•	•	•	•	•
<b>Run time function</b>	•	•	•	•	•
<b>Data export in Excel® format</b>	•	•	•	•	•
<b>Graphics</b>	•	•	•	•	•
<b>Layout function</b>		•	•	•	•
<b>Scheduler function</b>		•	•	•	•
<b>Global commands</b>		•	•	•	•
<b>Performance meter</b>		•	•	•	•
<b>Circular graphics</b>				•	•
<b>Supervision module</b>					•
<b>CRO module</b>					•





## ACCESSORIES: TX/RX MODULES FOR WIRELESS NETWORK – POWER ANALYSERS

### WIRELESS NETWORK MODULE



- ICOLL radio communication system for controlling and supervising units
- Cover all application fields, from single benches to cold rooms and compressor racks
- The information coming from the controller are transmitted to an XJ100 module and directly sent to the XJ150 connected to the XWEB unit
- Possibility to connect many instruments to the same XJ100
- Possibility to use XJ100 as a "bridge" for the signals sent by other modules
- Easy to use and less installation time and costs
- 0,25VA max power absorption
- Operating frequency: 433,5068MHz
- Range: 80m (no obstacles)
- Wall or panel mounting
- Power supply: XJ100 (5Vdc directly from the controller); XJ150 (5Vdc from PWS150J module)

### ICOLL

XJ100	Radio-frequency communication module to use with controllers		
XJ150	Radio-frequency communication module to use with controlling system		
PWS150J	XJ150 power supplier		

Standard: EN61000-6-3 (2001) + EN 61000-6-1 (2001)  
 ETSI EN 300 220-3 V1.1.1 (2000-09)  
 ETSI EN 301 489-3 V1.2.1 (2000) + ETSI EN 301 489-1 V1.2.1 (2000)

### POWER ANALYSERS – XWEB500 BRACKET

WM14	Power analyser, three-phase, with RS485 output. 90÷260Vac power supply. Dimensions: 107,5x90x63mm. DIN Rail and wall mounting. Housing: Self-extinguishing ABS. Operating temperature: 0÷55°C (32÷131°F). Relative humidity < 90%. Technical documentation on demand.	
WM22D	Single/three-phase, 400Vac energy analyser with RS485 output. Power supply: 230Vac. Dimensions: 162,5x90x63mm. Wall and DIN Rail mounting. Housing: self extinguishing ABS. Operating temperature: 0÷55°C (32÷131°F). Relative humidity<90%. Technical documentation on demand.	
XW-WA	XWEB500 wall mounting bracket	



D: 4 DIN Rail



## XJA-XJP-XJR SERIES: RELAY AND ACQUISITION MODULES

- 4 relay output modules, managed by monitoring system (XJR)
- Digital inputs for local enable/disable of relays (XJR)
- Data acquisition modules suitable for collecting data from any kind of installation (XJP)
- Up to 6 inputs for NTC, PTC, 4÷20mA and 0÷10V and 3 digital inputs or 4 Pt100 inputs and 4 digital inputs (XJP)
- Up to 10 line voltage inputs (XJA)
- Direct line power supply 230 (110)Vac. No external transformer required
- Remote display option
- Standard communication protocol ModBUS-RTU
- Hot Key or Prog tool kit connector for a quick and easy programming
- 6VA max power absorption

### HOW TO ORDER

XJR 

X	J	R	4	0	D	-	A	0	C	0	0
---	---	---	---	---	---	---	---	---	---	---	---

A	C
<b>Power supply</b>	<b>Buzzer</b>
2 = 24Vac/dc	0 = No
4 = 110Vac	1 = Yes
5 = 230Vac	

XJA-XJP30/60 

X	J				D	-	A	B	C	D	E
---	---	--	--	--	---	---	---	---	---	---	---

XJP40 

X	J	P	4	0	D	-	A	B	0	R	4
---	---	---	---	---	---	---	---	---	---	---	---

XJA50SL 

X	J	A	5	0	S	L	-	A	0	0	0	0
---	---	---	---	---	---	---	---	---	---	---	---	---

A	B	C	D	E
<b>Power supply</b>	<b>Measurement unit</b>	<b>Alarm relay</b>	<b>Probe inputs</b>	<b>Digital inputs</b>
2 = 24Vac/dc	C = °C	0 = No	P = PTC	3 = 3 digital inputs
4 = 110Vac	F = °F	1 = Yes (only for XJA50D)	N = NTC	4 = 4 digital inputs (only for XJP40D)
5 = 230Vac	N = No temperature		R = PT100 (only for XJP40D)	5 = 5 digital inputs (only for XJA50D)
			A = 4÷20mA	6 = 6 digital inputs
			W = 0÷10V	
			O = No	



# XJA-XJP-XJR

## RELAY MODULE and PROBE and ALARM ACQUISITION MODULES



D: 4 DIN Rail

<b>XJA50D</b> <b>XJA50SL</b>	Alarms/status acquisition modules, without display, able to read up to 5 + 5 independent inputs (master + slave)
<b>XJP30D</b> <b>XJP40D</b> <b>XJP60D</b>	Probes and alarms data acquisition modules, without display, able to read up to 9 different inputs
<b>XJR40D</b>	Relay module, without display, ables to manage 4 independent output relays

FEATURES	XJA50D	XJA50SL	XJP30D	XJP40D	XJP60D	XJR40D
<b>Keyboard: push buttons</b>						4
<b>Power supply</b>	24, 110, 230Vac	from controller	24, 110, 230Vac	24, 110, 230Vac	24, 110, 230Vac	24, 110, 230Vac
<b>Inputs</b>						
Analogue			3 x NTC/PTC/ 4÷20mA/0÷10V	4x Pt100	6*x NTC/PTC/ 4÷20mA/0÷10V	
Digital inputs (power supply voltage)	5	5	3	4	3	
Digital inputs (free of voltage contacts)			3 opt		3*	4
<b>Relay outputs</b>						
N° 4	5A opt					no 8A / nc 5A
<b>Other</b>						
Hot Key/Prog Tool Kit output	pres		pres	pres	pres	pres
Remote display/keyboard output	X-REP/KB1PRG		X-REP/KB1PRG	X-REP/KB1PRG	X-REP/KB1PRG	KB1PRG
Serial output	RS485		RS485	RS485	RS485	RS485
Analog output	5	5	3	4	6	1
Buzzer						opt

\*: XJP60D has 3 analogue inputs that are configurable as free of voltage digital inputs

### XJA50D

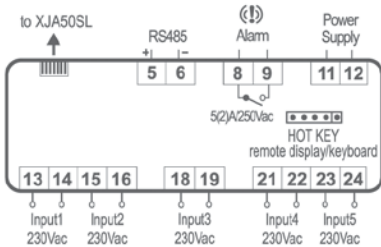

### XJA50SL

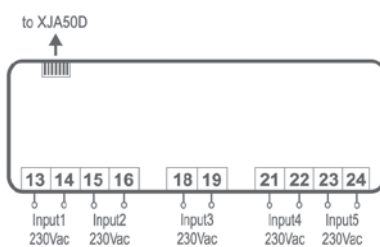

### XJP30D

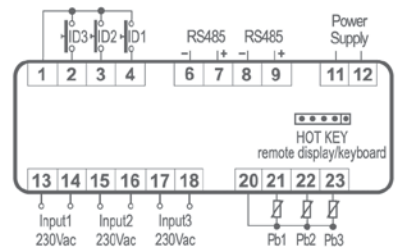

### XJP40D

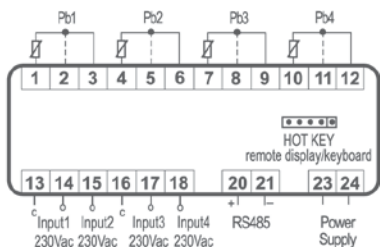

### XJP60D

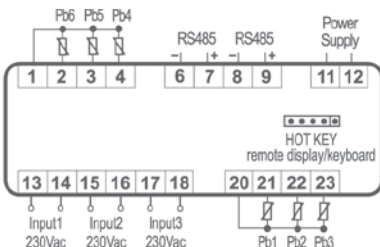

### XJR40D

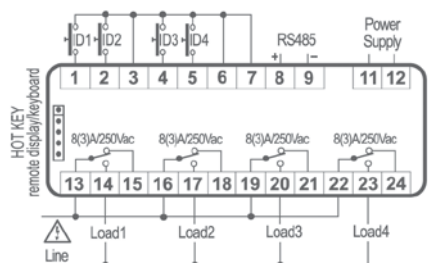

100x64mm

### KB1-PRG

6 key programming keyboard for  
XJA50D - XJP30D - XJP40D  
XJP60D - XJR40D

Display: n° digits: ± 3 d.p.

Keyboard: push buttons: 6



The cable **CAB/KB11** (1m) is designed to connect the keyboard with the XJA-XJP-XJR modules

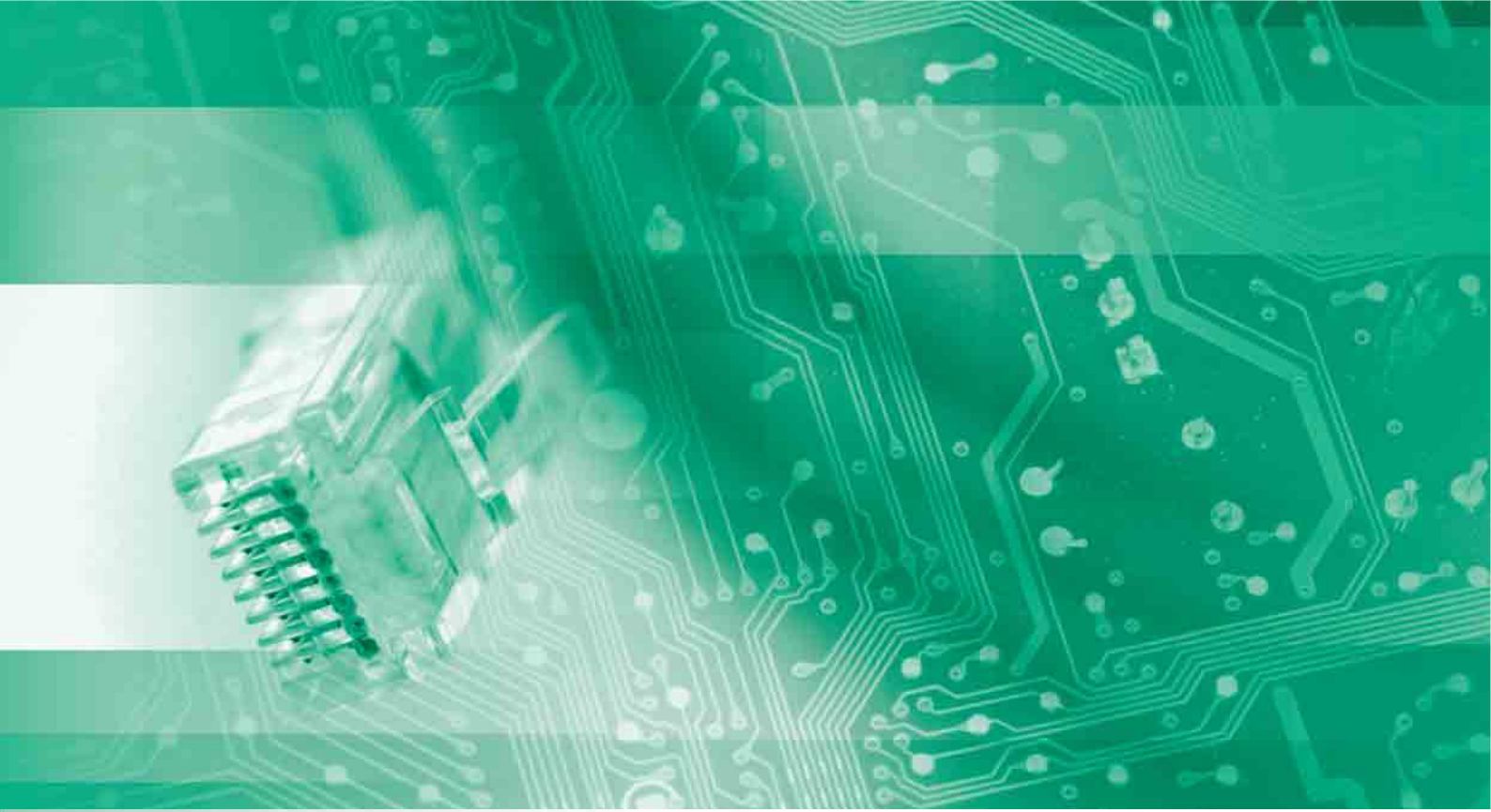

## PROGRAMMABLE CONTROLLERS

iPro family, dedicated whether for HVAC units (iPRO Chill and Domo) or for general purposes and refrigeration (iPRO Genius), is characterized by the most advanced technology in connectivity and processing speed.

It is based on a powerful platform that includes one hardware configuration that is able to expand the actual solution in the market, and a software that, thanks to the ISaGRAF® development environment allows the development through standard programming languages.

An easy and useful HMI is also guaranteed through the VISOGRAPH graphic display, as the expandability and the solution to many applications are satisfied with a complete range of accessories, among which, I/O expansion modules and proportional electronic valve management, modem, wiring...





# PROGRAMMABLE CONTROLLERS

## SECTION INDEX

FUNCTIONS	MODELS	
<b>iProGENIUS - general applications – high connectivity</b>		<b>36</b>
General purpose programmable controllers	IPG110D – IPG115D	39
Expansion module for programmable controllers	IPROEX60D	39
VISOGRAPH keyboard for programmable controllers	VGIPG	42
<b>XEV20D - stepper electronic expansion valve management</b>		<b>43</b>
Driver for unipolar and bipolar stepper electronic expansion valves	XEV20D	44
<b>ACCESSORIES - wiring - modems</b>		<b>45</b>
Wiring for programmable controllers	DWA30-KIT - DWB30-KIT - DWEX60-30KIT- DWXEV30	45
Modems and cables for programmable controllers	XWEB MODEM - TC35-KIT - CAB/WEB/NET - CAB/WEB/PC	45



D: 10 DIN Rail



D: 4 DIN Rail



82x156mm

## iProGENIUS SERIES: PROGRAMMABLE CONTROLLERS – HIGH CONNECTIVITY

The iProGenius family satisfy all requirements regarding the controlling and management of refrigeration, heating, ventilation, electric power and all building automation services.

They are suited for all applications in the PLC world and they find applications in many shopping centres, hospitals, airports, boatyards, energy management plants, and so on...

These controllers provide a high level of technology for ease of external connectivity and programmability providing simple answers to every application's needs, while ensuring a complete local or remote monitoring.

- Fully programmable controllers and high connectivity
- VISOGRAPH programmable graphic display (LCD – 240x96 pixel)
- Ethernet for connection to an intranet-internet network and to others programmable controllers for a distributed application management
- USB (host) that allows the download of applications, parameters, data/alarm logger and the applications and parameters upload
- CANBus digital communication serial protocol for the connection to other programmable controllers, to I/O expansion modules
- 2 master and slave RS485 serial output
- ModBUS-RTU standard communication protocol that allows connection to Dixell digital controllers, to XWEB supervising and controlling systems or to applications developed by third Party Systems
- BACnet communications allows the system to have easy and immediate integration with different manufactures ensuring a complete collaboration
- The possibility to have a connection to the expansion modules in order to increase system capacity
- 20VA max power absorption

### TECHNICAL DATA

LINUX Operative System  
 200MHz CPU  
 32bit processor  
 32MB RAM memory  
 128MB flash memory capacity

## ALARM MANAGEMENT

The alarm management system is the fundamental element that increases the plant efficiency, ensuring an immediate identification of plant problems and activates automatic strategies to prevent possible damages. The following possible options are available with iProGENIUS.

- Alarm sending management by e-mail, fax or sms
- Direct internet connection
- Point-to-point connection via modem, GSM and PDA modem
- Remote command sending via sms
- Possibility of updating the (iPro) on-board software via e-mail

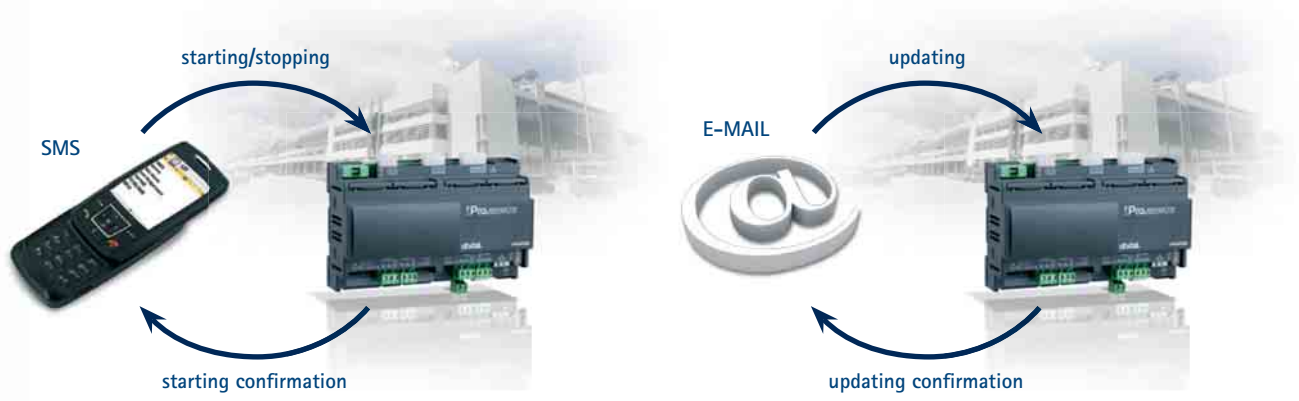

## PLANT STATUS DISPLAY

The plant maintenance staff can easily have a report of application status in order to decide how and when to intervene. The report contains all of the most important values, the plant status and operating set point.

## HOW TO ORDER

iProGENIUS 

I	P	G	1	1		D	-	1	B	C	1	0
---	---	---	---	---	--	---	---	---	---	---	---	---

<b>B</b>	<b>C</b>
<b>Modem</b>	<b>Ethernet</b>
0 = No 1 = Internal 2 = External (GSM/XWEB Modem)	0 = No 1 = Yes

DEVELOPMENT TOOL 

I	S	A	T	O	O	L	-	0	0	0	0	E
---	---	---	---	---	---	---	---	---	---	---	---	---

<b>E</b>
<b>Visoprog</b>
0 = No 1 = Yes

IProEX60D 

I	P	R	O	E	X	6	O	D	-	1	0	0	0	0
---	---	---	---	---	---	---	---	---	---	---	---	---	---	---

VisoGRAPH 

V	G	I	P	G	-	A	B	C	0	0
---	---	---	---	---	---	---	---	---	---	---

<b>A</b>	<b>B</b>	<b>C</b>
<b>Buzzer</b>	<b>Kind of mounting</b>	<b>Internal probe</b>
0 = No 1 = Yes	P = Panel W = Wall	0 = No 1 = Yes

## ISAGRAF®

In order to create programs that will be uploaded into the iPro series Dixell has selected ISaGRAF®; a software environment that enables you to create local or distributed control systems. ISaGRAF® offers a combination of a highly portable, robust management engine (Virtual Machine) and an intuitive application development environment (Workbench). The output of the development environment is selectable as either portable "C" source code or TIC (target independent code). The ISaGRAF® Virtual Machine is a powerful, optimized and very fast control engine that executes the TIC. Virtual Machine and all options are offered ready to use on NT, Linux, CE 3.0 and QNX. Additionally, this control engine has been designed such that the source code of the Virtual Machine is available in a toolkit format, providing portability to any OS on any hardware platform. The Enhanced options for ISaGRAF® transform this outstanding controller into a top of the line PLC, DCS or RTU.

## ISAGRAF® BECAUSE

- This development environment is international, complete, standard
- Is ideal for small applications but it can manage several I/O points
- It is the most used (more than 40.000 developers in the world and more than 500.000 applications in the last 10 years)
- It includes 5 different programming languages coded according to IEC61131
- It integrates the best system for simulation and remote debugging
- It is supported all over the world (essential for training and assistance)

The ISaGRAF® Application development Workbench supports all of the standard IEC 6-1131 control program languages plus Flow Chart.

- SFC: Sequential Function Chart
- ST: Structured Text
- FBD: Function Block Diagram
- IL: Instruction List
- FC: Flow Chart
- LD: Ladder Diagram

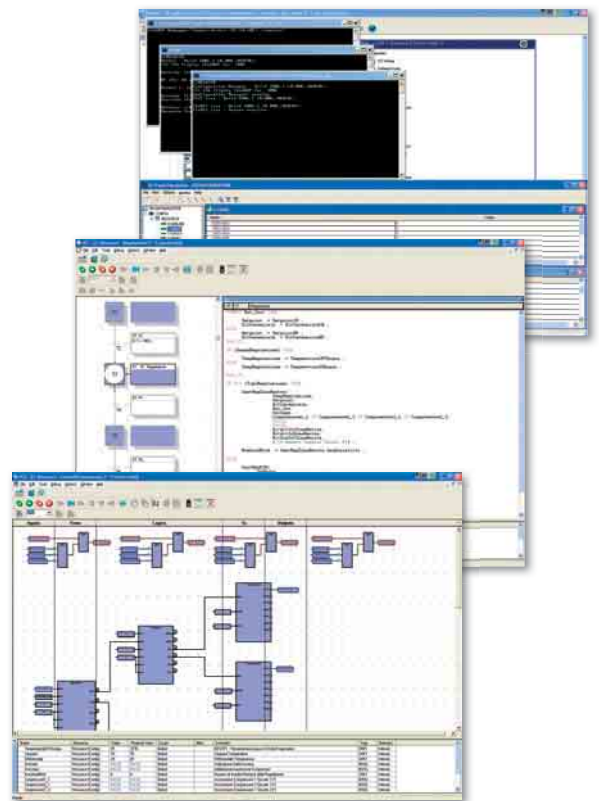

## DEVELOPMENT TOOLS

**ISA TOOL** is a complete tool, provided by Dixell, that allows the final user to work independently to create programs for iPro controllers, taking advantage of all the programmable series potential. The package includes manuals and the **WIZMATE** software, a useful instrument that allows a simple iPro controllers programming mode. Another utility provided by Dixell is the **VISOPROG** software for the graphic interfaces creation of **VISOGRAPH** displays.

The user can choose among 2 options:

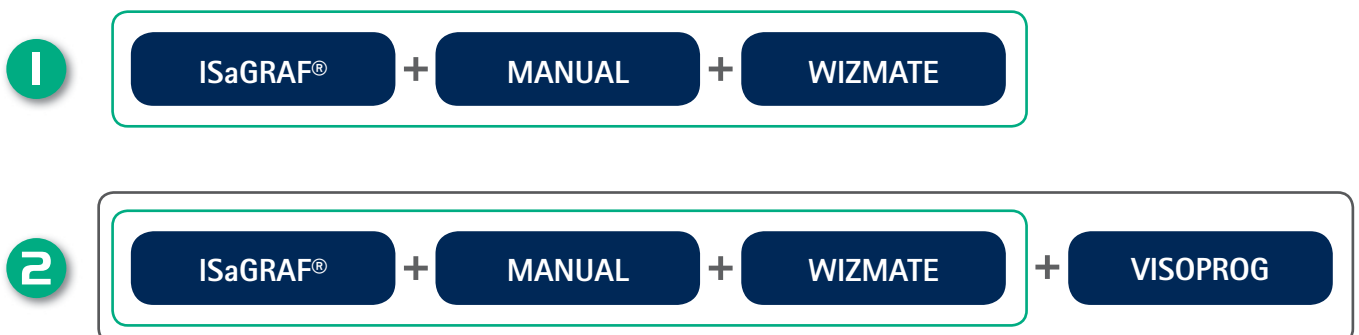



D: 4 DIN Rail



D: 10 DIN Rail

<b>IPG110D</b>	General purposes programmable controller with 10 relay outputs
<b>IPG115D</b>	General purposes programmable controller with 15 relay outputs
<b>I PROEX60D</b>	Expansion module for iPro family programmable controllers

FEATURES	IPG110D	IPG115D	I PROEX60D
<b>Power supply</b>	24Vac/dc (from TF20D)	24Vac/dc (from TF20D)	24Vac/dc (from TF10D)
<b>Probe inputs</b>			
0÷1V - 0÷5V - 0÷10V - 2÷20mA - 4÷20mA - NTC - PTC - DI	10 config	10 config	7 config
<b>Digital inputs</b>			
Opto-insulated	20 config	20 config	3 config
<b>Relay outputs</b>			
Configurable	9 x 5A + 1 x 8A	12 x 5A + 3 x 8A	6 x 5A
<b>Other outputs</b>			
PWM outputs for fan speed module	2	2	
0÷10V or 4÷20mA outputs for fan speed module	2 config	2 config	
0÷10V outputs for external relay drives	4 config	4 config	3 config
Remote keyboards (up to 2)	VGIPG	VGIPG	
Master serial output	RS485	RS485	
Slave serial output	RS485	RS485	
USB	pres	pres	
Modem output	GSM, XWEB Modem opt	GSM, XWEB Modem opt	
CANBus output	pres	pres	pres
Ethernet enabled	opt	opt	
<b>Other</b>			
Expansion module	I PROEX60D	I PROEX60D	
DIP switch for address selection			pres
Internal modem	opt	opt	
RTC	pres	pres	
Buzzer	pres	pres	

IPG110D - IPG115D

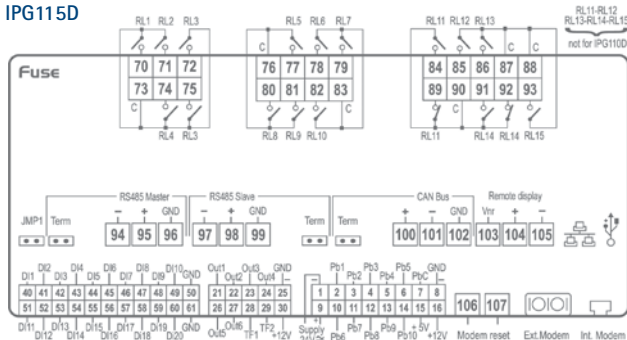

I PROEX60D

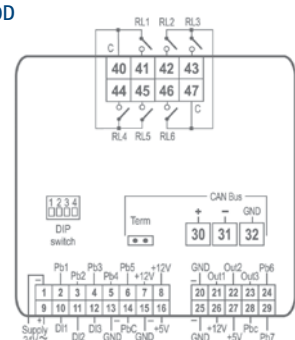

# iProGENIUS CONNECTIONS

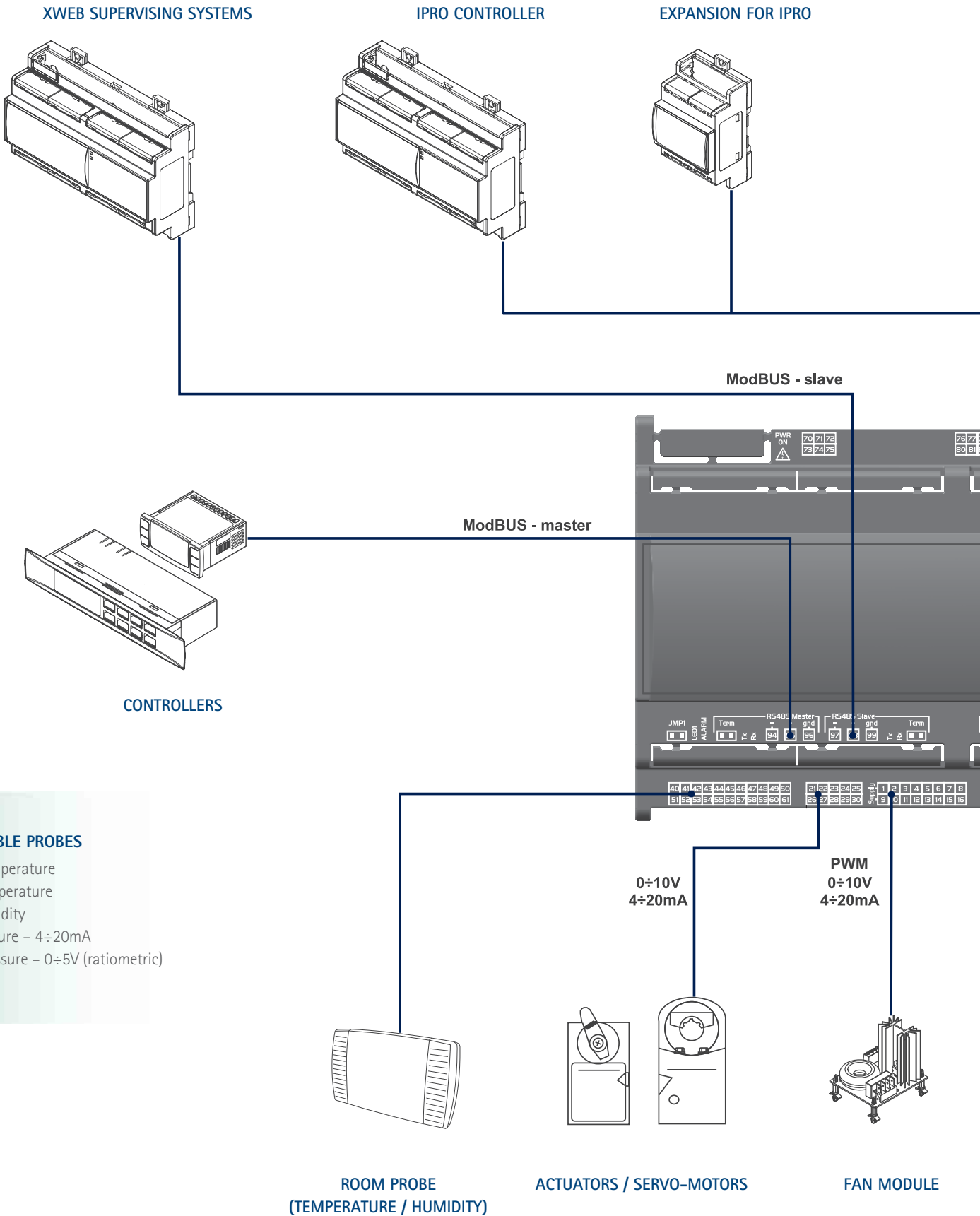



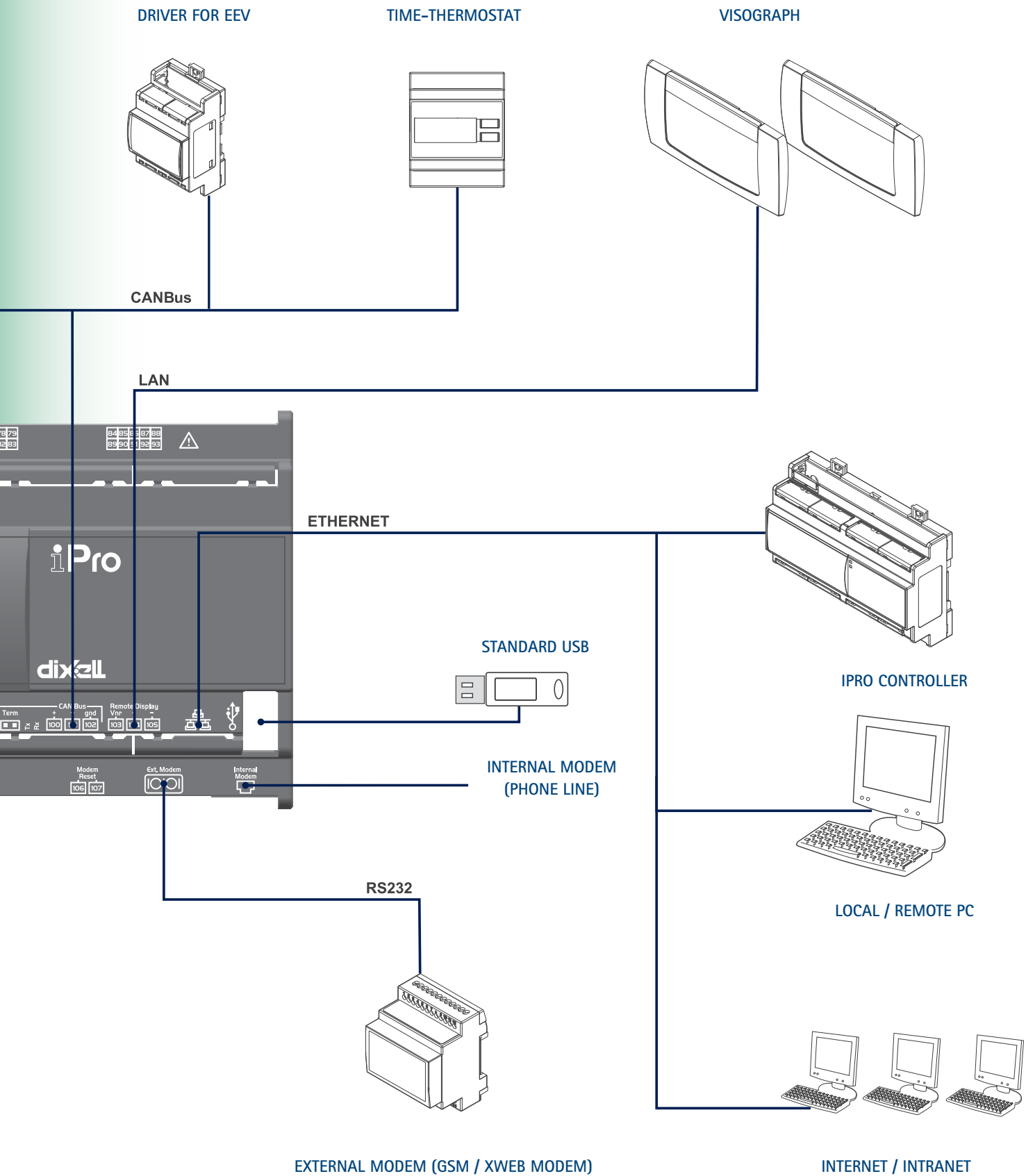

# VISOGRAPH

## PROGRAMMABLE GRAPHIC DISPLAY



82x156mm

VGIPG

Programmable graphic display (LCD – 240x96pixel) for programmable controllers

### FEATURES

For models  
Power supply  
VISOKEY output  
Buzzer  
Mounting

IPG110D – IPG115D  
From controller  
pres  
opt  
wall or panel

### VGIPG

- Great versatility and extensive customization opportunities
- Easy interface
- Complete integration with ISaGRAF® projects
- IP65 front protection
- Oriental characters support
- Keyboard lock function
- VISOPROG or iPro USB connector for an easy programming
- Up to 2 keyboards connectable to programmable controllers

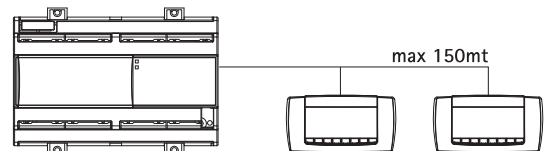

## VISOKEY

Programming key for VGIPG



## VISOPROG

The VISOPROG is a tool that allows one to create the VISOGRAPH keyboard graphic interfaces. The program, installed on a PC, is connected to ISaGRAF® project and has a basic interface that the user can easily customize depending on his requirements. VISOPROG allows one to transfer the user interface from a PC to a VGIPG keyboard. Follows a VISOPROG operating screens with the related VISOGRAPH final interface.

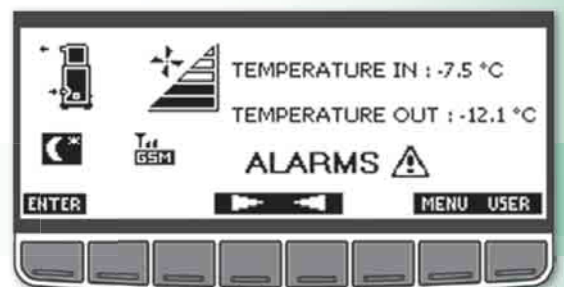
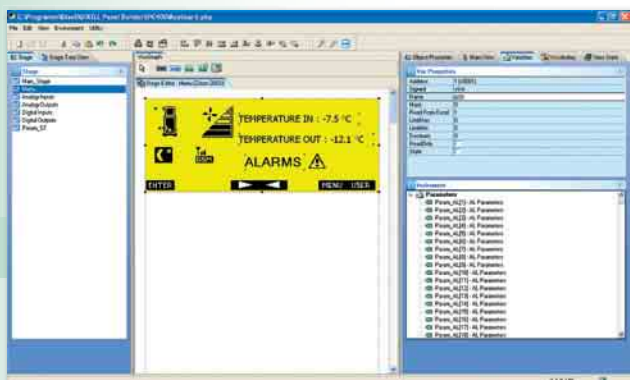



D: 4 DIN Rail

## XEV20D: STEPPER ELECTRONIC EXPANSION VALVE DRIVER MANAGEMENT

- iPro controllers driver for stepper electronic expansion valves management
- Ideal to control superheat regulation
- Energy savings improvement
- Single or double circuit
- Unipolar/bipolar stepper valve support as, for example, SPORLAN, ALCO, DANFOSS, SAGINOMIA and PARKER
- Temperature analog inputs (NTC, PTC, Pt1000)
- Pressure analog inputs (0÷5V, 4÷20mA)
- 4 position DIP Switch to set the address
- LAN output for the connection to other drivers or to parametric controllers
- CAN Bus output for the connection to iPro controllers series
- Up to 15 connectable driver modules using CANBus serial output
- Kind of available gas: R22, R134A, R404A, R407, R410, R507

### HOW TO ORDER

XEV20D 

X	E	V	2	0	D	-	1	1	C	0	0
---	---	---	---	---	---	---	---	---	---	---	---

	C	
--	---	--

N° of valves

0 = 1 valve

1 = 2 valves

# XEV20D

## DRIVER for UNIPOLAR and BIPOLAR STEPPER ELECTRONIC EXPANSION VALVES



D: 4 DIN Rail

XEV20D

Driver for unipolar and bipolar stepper electronic expansion valves can be used with iProGENIUS programmable controllers

### FEATURES

### XEV20D

#### Power supply

24Vac/dc (from TF20D/TF40D)

#### Probe inputs

0÷5V - 4÷20mA - NTC - PTC - Pt1000

up to 4 config

#### Other outputs

DIP switch for address selection

pres

LAN output

pres

CANBus output

pres

XEV20D - 1 circuit

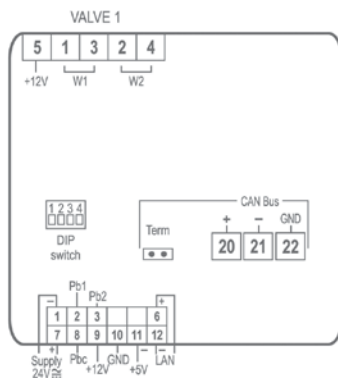

XEV20D - 2 circuits

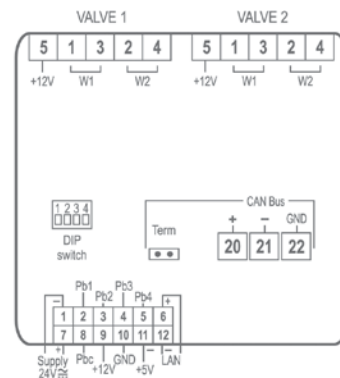

## TRANSFORMER SELECTION TABLE ACCORDING TO THE VALVES KIND AND NUMBER

KIND OF VALVE	XEV20D - 1 VALVE	XEV20D - 2 VALVES
<b>Bipolar – 4 wires</b> ALCO EX and EX5/8 SPORLAN SEI-SHE DANFOSS ETS	0.9A max current <b>TF20</b> (20VA) transformer	0.9A max current per valve <b>TF40</b> (40VA) transformer
<b>Unipolar – 5/6 wires</b> SPORLAN SAGINOMIA PARKER ESK	0.33A max current <b>TF20</b> (20VA) transformer	0.33A max current per valve <b>TF20</b> (20VA) transformer

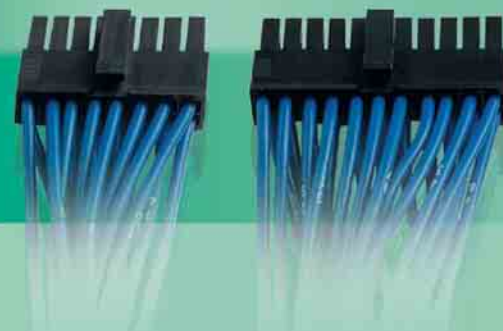

## ACCESSORIES: WIRING - MODEMS

### WIRING FOR PROGRAMMABLE CONTROLLERS

DWA30-KIT	for IPG110D	3 disconnectable female connectors, 10-16-22 pins with wires 3m and 2 disconnectable female connectors, 6-8 pins with wires 3m	
DWB30-KIT	for IPG115D	3 disconnectable female connectors, 10-16-22 pins with wires 3m and 3 disconnectable female connectors, 6-8-10 pins with wires 3m	
DWEX60-30KIT	for IPROEX60D	3 disconnectable female connectors, 8-10-16 pins with wires 3m	
DWXEV30	for XEV20D	Disconnectable female connectors, 12 pins with wires 3m	

### MODEMS AND CABLES FOR PROGRAMMABLE CONTROLLERS

XWEB MODEM	Analogue serial modem PDA compatible, 56kbps (DIN Rail format) HOW TO ORDER: XWEBMODEM-200 (with 24Vac power supply) XWEBMODEM-400 (with 110Vac power supply) XWEBMODEM-500 (with 230Vac power supply)	
TC35-KIT	GSM modem kit containing the modem, the power supply unit, the transmitting antenna with the relevant cable and the connection to controlling system	
CAB/WEB/NET	Ethernet patch cable, 3m	
CAB/WEB/PC	Ethernet patch cross over cable, 1m	



## PARAMETRIC CONTROLLERS

Different needs that crowd the refrigeration world are satisfied with a complete series of parametric controllers with an innovative design and intuitive interfaces.

Intelligent algorithms, that are oriented toward **energy savings** and innovative functions mark a range of products that includes different fields in the cooling world offers a wide range of general purpose solutions, for multiplexed cabinets, cabinets and rooms, blast chiller, compressor racks and refrigerated trucks. Specific solutions that are used also in applications such as fan speed control, heated cabinets and ovens and in temperature, humidity and pressure regulation.





# GENERAL PURPOSE REFRIGERATION CONTROLLERS

## SECTION INDEX

FUNCTIONS	MODELS	
<b>PRIME CX - NT, MT and LT applications - serial output</b>		<b>48</b>
Thermostat and "off cycle" defrost controller	XR10CX - XR20CX	49
N.T. - M.T. - L.T. controllers	XR30CX - XR35CX - XR36CX - XR40CX - XR50CX - XR56CX	49
M.T. - L.T. controllers	XR60CX - XR64CX - XR70CX - XR71CX - XR72CX - XR75CX	51
<b>PRIME D - NT, MT and LT applications</b>		<b>53</b>
Thermostat and "off cycle" defrost controller	XR10D - XR20D	54
N.T. - M.T. - L.T. controllers	XR30D - XR40D	54
M.T. - L.T. controllers	XR60D - XR70D	55
Milk tank controllers	XR80D	55
<b>XR100/500 - NT, MT and LT applications - RS485 output</b>		<b>56</b>
Thermostat and "off cycle" defrost multifunction controllers with RS485	XR110C - XR120C - XR120D	57
Multifunction controllers with RS485 for N.T. - M.T. - L.T.	XR130C - XR130D - XR140C - XR140D	58
Multifunction controllers with RS485 for M.T. - L.T.	XR150C-XR160C-XR160D-XR170C-XR170D-XR172C-XR40SL	59
Multifunction controllers with RS485 and real time clock for N.T. - M.T. - L.T.	XR530C - XR530D - XR563D	61
Multifunction controllers with RS485 and real time clock for M.T. - L.T.	XR570C - XR570D - XR572C - XR40SL	62
<b>THERMOMETER - LCD &amp; LED thermometers</b>		<b>63</b>
Thermometer with liquid crystal display	LC11	64
LED thermometers	XT11S - XR100C - XA100C	64

# Prime



CX: 32x74mm

IP65

CX  
line



## PRIME CX SERIES: NT, MT AND LT APPLICATIONS – SERIAL OUTPUT

- Innovative digital controllers dedicated to heat and M.T. – LT. refrigeration
- Easy and intuitive programming mode
- Display with icons and integrated measurement units
- On/off key
- Plastic front frame with "cut out" "WING" compatible
- Up to 2 light switches
- Energy saving cycles through digital input
- Fast freezing with dedicated set point
- Regulation stop through auxiliary probe
- Regulation restart with door open alarm
- Temperature or HACCP Max and Min functions
- Configurable digital input also as probe
- Virtual probe management
- Condenser temperature management to prevent critical plant situations
- Hot Key connector for a quick and easy programming
- Serial line connection to monitoring systems
- Connection for X-REP remote display (alternative to TTL output)
- 3VA max power absorption
- Display with red LED (10,5mm high) and icons

### HOW TO ORDER

PRIME CX [X] [R] [ ] [ ] [C] [X] [ ] [A] [B] [C] [D] [E]

**-17.8**

For blue display please contact Dixell

A		B		C			D			E	
Power supply	Inputs	Buzzer	X-REP (excludes TTL output)	RS485 output (only for XR35/75CX)	Measurement unit	RTC	Compressor output	Connections			
0 = 12Vac/dc	P = PTC	0 No	No	No	C °C	No	0 8A	Screw			
1 = 24Vac/dc	N = NTC	1 Yes	No	No	F °F	No	1 20A	Screw			
2 = 24Vac	S = Pt1000 only	2 No	Yes	No	H °C Heating only for XR10CX	No	3 16A	Screw			
3 = 9÷40Vdc	for XR35/75CX	3 Yes	Yes	No	L °F Heating only for XR10CX	No	6 8A	Faston			
4 = 110Vac		4 No	No	Yes	I °C	Yes	7 20A	Faston			
5 = 230Vac		5 Yes	No	Yes	M °F	Yes	8 16A	Faston			
		6 No	Yes	Yes							
		7 Yes	Yes	Yes							



# PRIME CX

## THERMOSTAT and CONTROLLERS with "OFF CYCLE" DEFROST for NORMAL, MEDIUM and LOW TEMPERATURE



CX: 32x74mm

<b>XR10CX</b>	Digital thermostat with heating or cooling action
<b>XR20CX</b>	Digital controller for N.T. with "off cycle" defrost
<b>XR30CX</b>	Digital controller for N.T. with "off cycle" defrost and additional configurable relay
<b>XR35CX</b>	Digital controller for N.T. with "off cycle" defrost, additional configurable relay and RS485
<b>XR36CX</b>	2 set point digital controller for N.T. with "off cycle" defrost

FEATURES	XR10CX	XR20CX	XR30CX	XR35CX	XR36CX
<b>Display: n° digits</b>	± 3 d.p.	± 3 d.p.	± 3 d.p.	± 3 d.p.	± 3 d.p.
<b>Power supply</b>	12, 24Vac/dc 24, 110, 230Vac 9÷40Vdc *	12, 24Vac/dc 24, 110, 230Vac 9÷40Vdc *	12, 24Vac/dc 24, 110, 230Vac 9÷40Vdc *	24, 110, 230Vac	12, 24Vac/dc 24, 110, 230Vac 9÷40Vdc *
<b>Probe inputs</b>					
Thermostat	NTC/PTC	NTC/PTC	NTC/PTC	PTC/Pt1000	NTC/PTC
Thermostat 2					NTC/PTC
Defrost				PTC/Pt1000	
Defrost 2					
Condenser	NTC/PTC on HOT KEY	NTC/PTC on HOT KEY	NTC/PTC on HOT KEY	PTC/Pt1000	NTC/PTC on HOT KEY
<b>Digital inputs</b>					
Alarm, start defrost, AUX, door switch, pressure switch, probe	config	config	config	config	config
Alarm, start defrost, AUX, door switch, pressure switch				config	
<b>Relay outputs</b>					
Compressor	8A, 20A opt	8A, 20A opt	8A, 20A opt	8A, 16A opt	8A, 20A opt
Compressor 2					
Thermostat 2					8A
Defrost					
Defrost 2					
Fans					
Light or alarm			8A		
Anti-sweat				8A	
<b>Other</b>					
Hot Key/Prog Tool Kit output	pres	pres	pres	pres	pres
Remote display output	X-REP opt	X-REP opt	X-REP opt	X-REP opt	X-REP opt
Serial output	TTL	TTL	TTL	TTL/RS485 opt	TTL
Buzzer	opt	opt	opt	opt	opt
Real time clock			opt	opt	

\*: only for models with compressor = 8A

**XR10CX  
XR20CX**

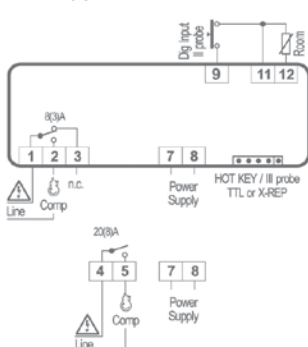

**XR30CX**

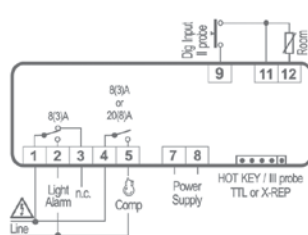

**XR35CX**

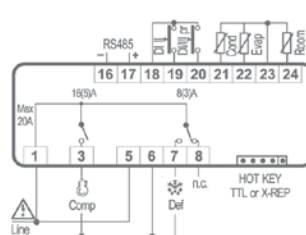

**XR36CX**

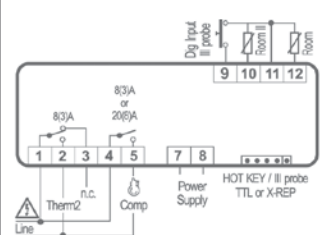

# PRIME CX

## CONTROLLERS for NORMAL, MEDIUM and LOW TEMPERATURE



CX: 32x74mm

<b>XR40CX</b>	Digital controller for M.T. and L.T. with electrical or hot gas defrost
<b>XR50CX</b>	Digital controller for M.T. and L.T. with electrical or hot gas defrost and auxiliary relay
<b>XR56CX</b>	2 set point digital controller for M.T. and L.T. with electrical or hot gas defrost and auxiliary relay

FEATURES	XR40CX	XR50CX		XR56CX	
<b>Display: n° digits</b>	± 3 d.p.	± 3 d.p.	± 3 d.p.	± 3 d.p.	± 3 d.p.
<b>Power supply</b>	12, 24Vac/dc 24, 110, 230Vac 9÷40Vdc *	12, 24Vac/dc 24, 110, 230Vac 9÷40Vdc *	24, 110, 230Vac	12, 24Vac/dc 24, 110, 230Vac 9÷40Vdc *	24, 110, 230Vac
<b>Probe inputs</b>					
Thermostat	NTC/PTC	NTC/PTC	NTC/PTC	NTC/PTC	NTC/PTC
Thermostat 2				NTC/PTC	NTC/PTC
Defrost	NTC/PTC	NTC/PTC	NTC/PTC		
Defrost 2					
Condenser	NTC/PTC on HOT KEY	NTC/PTC on HOT KEY	NTC/PTC on HOT KEY	NTC/PTC on HOT KEY	NTC/PTC on HOT KEY
<b>Digital inputs</b>					
Alarm, start defrost, AUX, door switch, pressure switch, probe	config	config	config	config	config
Alarm, start defrost, AUX, door switch, pressure switch					
<b>Relay outputs</b>					
Compressor	8A, 20A opt	8A, 16A opt	20A	8A, 16A opt	20A
Compressor 2					
Thermostat 2				8A	8A
Defrost	8A	8A	8A		
Defrost 2					
Fans					
Light or alarm		8A	5A	8A	5A
Anti-sweat					
<b>Other</b>					
Hot Key/Prog Tool Kit output	pres	pres	pres	pres	pres
Remote display output	X-REP opt	X-REP opt	X-REP opt	X-REP opt	X-REP opt
Serial output	TTL	TTL	TTL	TTL	TTL
Buzzer	opt	opt	opt	opt	opt
Real time clock					

\*: only for models with compressor = 8A

XR40CX

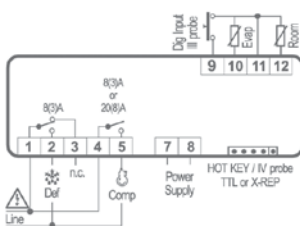

XR50CX

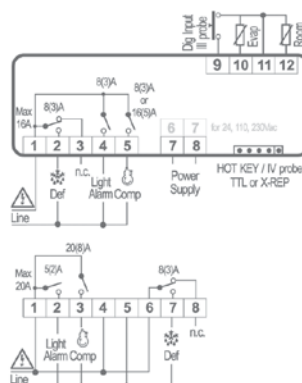

XR56CX

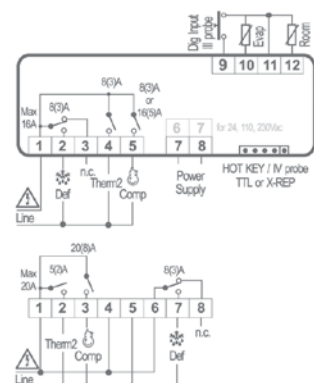

# PRIME CX

## CONTROLLERS for MEDIUM and LOW TEMPERATURE



CX: 32x74mm

<b>XR60CX</b>	Digital controller for M.T. and L.T. ventilated applications with dual humidity function
<b>XR64CX</b>	Digital controller for M.T. and L.T. ventilated applications with dual evaporator
<b>XR70CX</b>	Digital controller for M.T. and L.T. ventilated applications with auxiliary relay and dual humidity function

FEATURES	XR60CX		XR64CX		XR70CX	
<b>Display: n° digits</b>	± 3 d.p.	± 3 d.p.	± 3 d.p.	± 3 d.p.	± 3 d.p.	± 3 d.p.
<b>Power supply</b>	12, 24Vac/dc 24, 110, 230Vac 9÷40Vdc *	24, 110, 230Vac	24, 110, 230Vac	12Vac/dc	24, 110, 230Vac	12Vac/dc
<b>Probe inputs</b>						
Thermostat	NTC/PTC	NTC/PTC	NTC/PTC	NTC/PTC	NTC/PTC	NTC/PTC
Thermostat 2						
Defrost	NTC/PTC	NTC/PTC	NTC/PTC	NTC/PTC	NTC/PTC	NTC/PTC
Defrost 2			NTC/PTC	NTC/PTC		
Condenser	NTC/PTC on HOT KEY	NTC/PTC on HOT KEY	NTC/PTC on HOT KEY	NTC/PTC on HOT KEY	NTC/PTC on HOT KEY	NTC/PTC on HOT KEY
<b>Digital inputs</b>						
Alarm, start defrost, AUX, door switch, pressure switch, probe	config	config	config	config	config	config
Alarm, start defrost, AUX, door switch, pressure switch						
<b>Relay outputs</b>						
Compressor	8A, 16A opt	20A	8A, 16A opt	16A	8A, 16A opt	16A
Compressor 2						
Thermostat 2						
Defrost	8A	8A	8A	16A	8A	16A
Defrost 2			8A	16A		
Fans	8A	5A	5A	16A	5A	16A
Light or alarm					8A	
Anti-sweat						
<b>Other</b>						
Hot Key/Prog Tool Kit output	pres	pres	pres	pres	pres	pres
Remote display output	X-REP opt	X-REP opt	X-REP opt	X-REP opt	X-REP opt	X-REP opt
Serial output	TTL	TTL	TTL	TTL	TTL	TTL
Buzzer	opt	opt	opt	opt	opt	opt
Real time clock						

\*: only for models with compressor = 8A

XR60CX

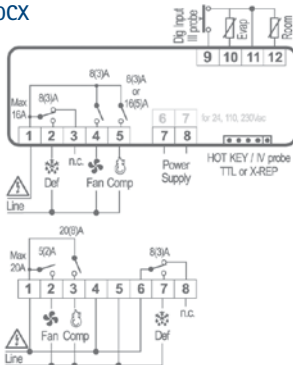

XR64CX

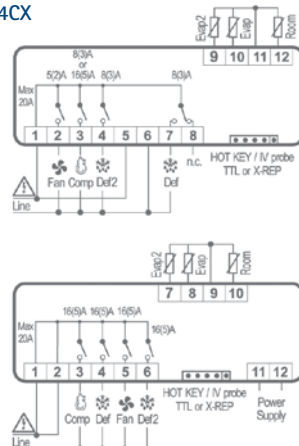

XR70CX

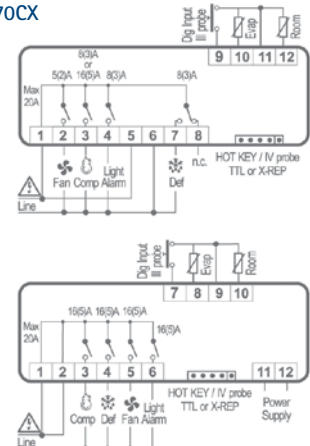

# PRIME CX

## CONTROLLERS for MEDIUM and LOW TEMPERATURE



CX: 32x74mm

<b>XR71CX</b>	Digital controller for M.T. and L.T. ventilated applications with anti-sweat heaters management
<b>XR72CX</b>	Digital controller for M.T. and L.T. ventilated applications with dual compressor management
<b>XR75CX</b>	Digital controller for M.T. and L.T. ventilated applications with auxiliary relay, dual humidity function and RS485

FEATURES	XR71CX		XR72CX		XR75CX
<b>Display: n° digits</b>	± 3 d.p.	± 3 d.p.	± 3 d.p.	± 3 d.p.	± 3 d.p.
<b>Power supply</b>	24, 110, 230Vac	12Vac/dc	24, 110, 230Vac	12Vac/dc	24, 110, 230Vac
<b>Probe inputs</b>					
Thermostat	NTC/PTC	NTC/PTC	NTC/PTC	NTC/PTC	PTC/Pt1000
Thermostat 2					
Defrost	NTC/PTC	NTC/PTC	NTC/PTC	NTC/PTC	PTC/Pt1000
Defrost 2					
Condenser	NTC/PTC on HOT KEY	NTC/PTC on HOT KEY	NTC/PTC on HOT KEY	NTC/PTC on HOT KEY	PTC/Pt1000
<b>Digital inputs</b>					
Alarm, start defrost, AUX, door switch, pressure switch, probe	config	config	config	config	config
Alarm, start defrost, AUX, door switch, pressure switch					config
<b>Relay outputs</b>					
Compressor	8A, 16A opt	16A	8A, 16A opt	16A	8A, 16A opt
Compressor 2			8A	16A	
Thermostat 2					
Defrost	8A	16A	8A	16A	8A
Defrost 2					
Fans	5A	16A	5A	16A	5A
Light or alarm					8A
Anti-sweat	8A	16A			
<b>Other</b>					
Hot Key/Prog Tool Kit output	pres	pres	pres	pres	pres
Remote display output	X-REP opt	X-REP opt	X-REP opt	X-REP opt	X-REP opt
Serial output	TTL	TTL	TTL	TTL	TTL/RS485 opt
Buzzer	opt	opt	opt	opt	opt
Real time clock					opt

XR71CX

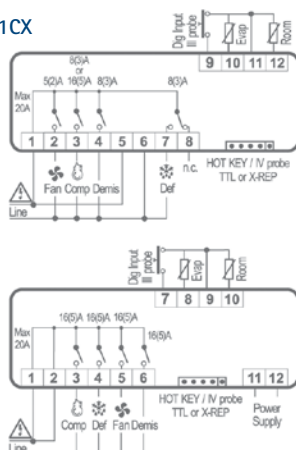

XR72CX

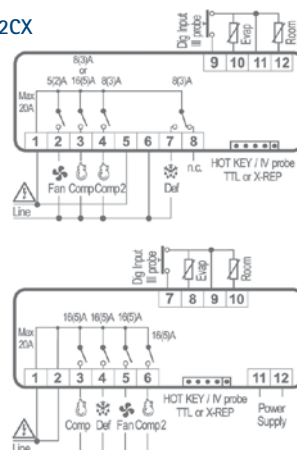

XR75CX

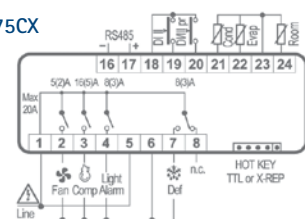



D: 4 DIN Rail



## PRIME D SERIES: CONTROLLERS FOR NT, MT AND LT

- Innovative digital controllers dedicated to normal and low temperature refrigerated applications
- Direct line power supply 230 (110)Vac. No external transformer required
- Direct driving of compressors up to 1,2HP, (20A relay inside)
- Pre-programming of the main control variables, easy and intuitive programming mode
- Keyboard lock, alarm signalling by relay, display or buzzer
- Configurable digital input for door switch, defrost, general or serious alarm
- Auxiliary relay activated through keys or digital input
- Hot Key connector for a quick and easy programming
- HACCP function
- 3VA max power absorption
- Display with red LED (13,2mm high)

### HOW TO ORDER

PRIME D  X  R    D -  A  B  C  D  E

**-17.8**

For blue display please contact Dixell

A	B	C	D	E
<b>Power supply</b>	<b>Input</b>	<b>Buzzer</b>	<b>Measurement unit</b>	<b>Compressor output</b>
<b>2</b> = 24Vac <b>4</b> = 110Vac <b>5</b> = 230Vac	<b>P</b> = PTC <b>N</b> = NTC	<b>0</b> = No <b>1</b> = Yes	<b>C</b> = °C <b>F</b> = °F <b>H</b> = °C heating only for XR10D <b>L</b> = °F heating only for XR10D	<b>0</b> = 8A <b>1</b> = 20A

# PRIME D

## THERMOSTAT and CONTROLLERS for NORMAL, MEDIUM and LOW TEMPERATURE



D: 4 DIN Rail

<b>XR10D</b>	Digital thermostat with heating or cooling action
<b>XR20D</b>	Digital controller for N.T. with "off cycle" defrost
<b>XR30D</b>	Digital controller for N.T. with "off cycle" defrost and additional configurable relay
<b>XR40D</b>	Digital controller for M.T. and L.T. with electrical or hot gas defrost

FEATURES	XR10D	XR20D	XR30D	XR40D
<b>Display: n° digits</b>	± 3 d.p.	± 3 d.p.	± 3 d.p.	± 3 d.p.
<b>Power supply</b>	24, 110, 230Vac	24, 110, 230Vac	24, 110, 230Vac	24, 110, 230Vac
<b>Probe inputs</b>				
Thermostat	NTC/PTC	NTC/PTC	NTC/PTC	NTC/PTC
Defrost				NTC/PTC
<b>Digital inputs</b>				
Alarm, start defrost, AUX, door switch, pressure switch	config	config	config	config
<b>Relay outputs</b>				
Compressor	no 8A / nc 5A, 20A opt	no 8A / nc 5A, 20A opt	no 8A / nc 5A, 20A opt	no 8A / nc 5A, 20A opt
Defrost				no 8A / nc 5A
Fans				
Alarm				
Agitator				
Alarm or auxiliary			no 8A / nc 5A	
<b>Other</b>				
Functions	HACCP	HACCP	HACCP	HACCP
Hot Key output	pres	pres	pres	pres
Buzzer	opt	opt	opt	opt

XR10D  
XR20D

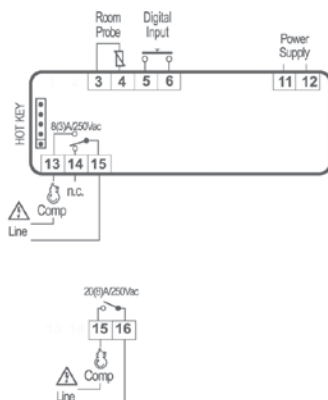

XR30D

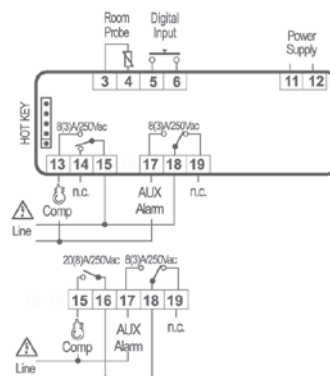

XR40D

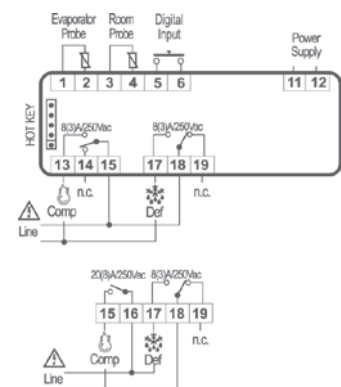

# PRIME D

## CONTROLLERS for MEDIUM and LOW TEMPERATURE and for MILK TANK CONTROLLERS



D: 4 DIN Rail

<b>XR60D</b>	Digital controller for M.T. and L.T. ventilated applications with door switch capability
<b>XR70D</b>	Digital controller for M.T. and L.T. for ventilated applications with door switch capability and auxiliary relay
<b>XR80D</b>	Digital controller for milk tank refrigerators with agitation cycle capability

FEATURES	XR60D	XR70D	XR80D
<b>Display: n° digits</b>	± 3 d.p.	± 3 d.p.	± 3 d.p.
<b>Power supply</b>	24, 110, 230Vac	24, 110, 230Vac	24, 110, 230Vac
<b>Probe inputs</b>			
Thermostat	NTC/PTC	NTC/PTC	NTC/PTC
Defrost	NTC/PTC	NTC/PTC	
<b>Digital inputs</b>			
Alarm, start defrost, AUX, door switch, pressure switch	config	config	
<b>Relay outputs</b>			
Compressor	no 8A / nc 5A, 20A opt	no 8A / nc 5A, 20A opt	no 8A / nc 5A, 20A opt
Defrost	no 8A / nc 5A	no 8A / nc 5A	
Fans	8A	8A	
Alarm		no 8A / nc 5A	
Agitator			no 8A / nc 5A opt
Alarm or auxiliary			no 8A / nc 5A
<b>Other</b>			
Functions	HACCP	HACCP	min/max
Hot Key output	pres	pres	pres
Buzzer	opt	opt	opt

XR60D

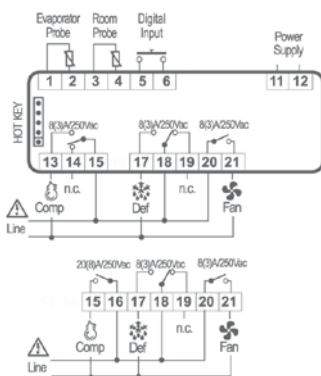

XR70D

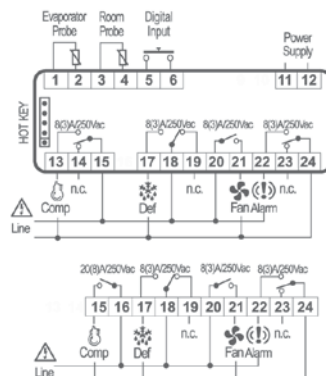

XR80D

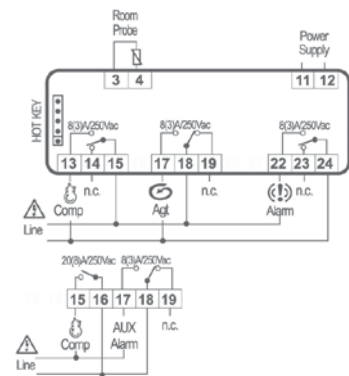



D: 4 DIN Rail



C: 32x74mm

## XR100/500 SERIES: CONTROLLERS FOR NT, MT AND LT – RS485 OUTPUT

- Digital controllers suitable for both heating and cooling applications
- Built in RS485 for connection to Dixell's monitoring system
- Temperature control can be performed on probe 1, probe 2 or by the difference between probe 1 and 2
- Complete compressor and defrost management
- Recording of minimum and maximum temperatures
- Standard communication protocol ModBUS-RTU
- Hot Key or Prog tool kit connector for a quick and easy programming
- 3VA max power absorption
- Display with red LED (13,2 mm high)

### HOW TO ORDER

XR100/500  X  R     -  A  B  C  D  E

 For blue display please contact Dixell

XR40SL  X  R  4  0  S  L -  A  0  0  0  0

A	B	C	D	E		
Power supply	Input	Compressor	Measurement unit	Built-in RS485	4÷20mA	X-REP
<b>0</b> = 12Vac/dc <b>1</b> = 24Vac/dc <b>2</b> = 24Vac <b>4</b> = 110Vac <b>5</b> = 230Vac <b>6</b> = 110/230Vac	<b>P</b> = PTC <b>N</b> = NTC	<b>0</b> = 8A <b>1</b> = 20A for XR110C and XR120C	<b>C</b> = °C <b>F</b> = °F <b>H</b> = °C heating for XR110C <b>L</b> = °F heating for XR110C <b>K</b> = °C no evaporator probe for XR140C <b>Y</b> = °F no evaporator probe for XR140C	<b>1</b> Yes <b>2</b> Yes <b>3</b> No <b>4</b> No	No No Yes Yes	No Yes No Yes



# XR100

## THERMOSTAT and "OFF CYCLE" DEFROST MULTIFUNCTION CONTROLLERS with RS485 OUTPUT



C: 32x74mm



D: 4 DIN Rail

XR110C

Digital thermostat for heating or cooling action with built in RS485

XR120C  
XR120D

Digital controllers, with built in RS485, for N.T. with "off cycle" defrost

FEATURES	XR110C	XR120C	XR120D
<b>Display: n° digits</b>	± 3 d.p.	± 3 d.p.	± 3 d.p.
<b>Power supply</b>	12Vac/dc, 24Vac/dc opt 110, 230Vac	12Vac/dc, 24Vac/dc opt 110, 230Vac	110, 230Vac
<b>Probe inputs</b>			
Thermostat	NTC/PTC	NTC/PTC	NTC/PTC
Defrost			
Display			NTC/PTC
<b>Digital inputs</b>			
Start defrost, pressure switch, energy saving, AUX, generic alarm, serious alarm mode	config	config	config
Door switch			pres
<b>Relay outputs</b>			
Compressor	8A, 20A opt	8A, 20A opt	8A
Defrost			
Fans			
Alarm			
<b>Other</b>			
Hot Key/Prog Tool Kit output	pres	pres	pres
Remote display output			
Serial output	RS485	RS485	RS485
Analog output			
Buzzer	pres	pres	pres
Real time clock			

XR110C  
XR120C

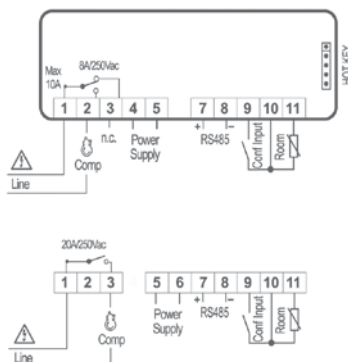

XR120D

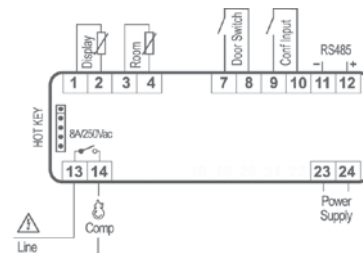

# XR100

## MULTIFUNCTION CONTROLLERS with RS485 OUTPUT for NORMAL, MEDIUM and LOW TEMPERATURE



C: 32x74mm



D: 4 DIN Rail

**XR130C**  
**XR130D**

Digital controllers for N.T. with "off cycle" defrost, additional configurable relay and built in RS485

**XR140C**  
**XR140D**

Digital controllers for M.T. and L.T. refrigerated applications with electrical or hot gas defrost function and built in RS485

FEATURES	XR130C	XR130D	XR140C	XR140D
<b>Display: n° digits</b>	± 3 d.p.	± 3 d.p.	± 3 d.p.	± 3 d.p.
<b>Power supply</b>	12Vac/dc 24 Vac/dc opt	110, 230Vac	12Vac/dc 24Vac/dc opt	110, 230Vac
<b>Probe inputs</b>				
Thermostat	NTC/PTC	NTC/PTC	NTC/PTC	NTC/PTC
Defrost			NTC/PTC	NTC/PTC
Display	NTC/PTC	NTC/PTC	NTC/PTC	NTC/PTC
<b>Digital inputs</b>				
Start defrost, pressure switch, energy saving, AUX, generic alarm, serious alarm mode	config	config	config	config
Door switch	pres	pres	pres	pres
<b>Relay outputs</b>				
Compressor	8A	8A	8A	8A
Defrost			8A	no 8A / nc 5A
Fans				
Alarm	8A	16A		
<b>Other</b>				
Hot Key/Prog Tool Kit output	pres	pres	pres	pres
Remote display output	X-REP opt		X-REP opt	
Serial output	RS485	RS485	RS485	RS485
Analog output	4÷20mA opt		4÷20mA opt	
Buzzer	pres	pres	pres	pres
Real time clock				

**XR130C**

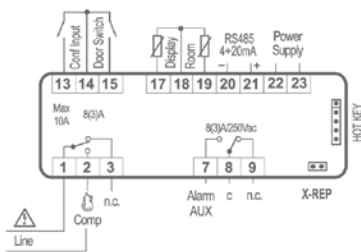

**XR130D**

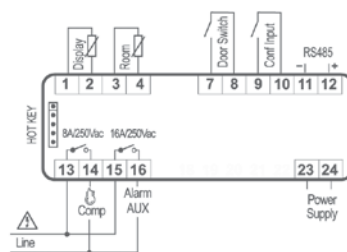

**XR140C**

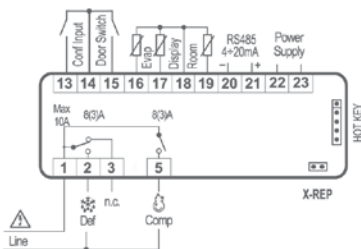

**XR140D**

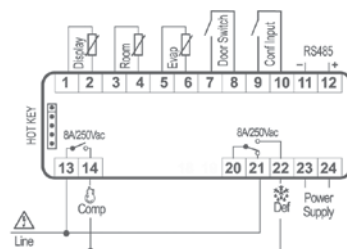

# XR100

## MULTIFUNCTION CONTROLLERS with RS485 OUTPUT for MEDIUM and LOW TEMPERATURE



C: 32x74mm

D: 4 DIN Rail

**XR150C**

Digital controller for M.T. and LT. refrigerated applications with electrical or hot gas defrost function, auxiliary relay and built in RS485

**XR160C  
XR160D**

Digital controllers for M.T. and LT. ventilated applications with door switch capability and built in RS485

FEATURES	XR150C	XR160C	XR160D
<b>Display: n° digits</b>	± 3 d.p.	± 3 d.p.	± 3 d.p.
<b>Power supply</b>	12, 24Vac/dc	12, 24Vac/dc	110, 230Vac
<b>Probe inputs</b>			
Thermostat	NTC/PTC	NTC/PTC	NTC/PTC
Defrost	NTC/PTC	NTC/PTC	NTC/PTC
Display	NTC/PTC	NTC/PTC	NTC/PTC
<b>Digital inputs</b>			
Start defrost, pressure switch, energy saving, AUX, generic alarm, serious alarm mode	config	config	config
Door switch	pres	pres	pres
<b>Relay outputs</b>			
Compressor	8A	8A	8A
Defrost	8A	8A	no 8A / nc 5A
Fans		8A	8A
Alarm	8A		
<b>Other</b>			
Hot Key/Prog Tool Kit output	pres	pres	pres
Remote display output	X-REP opt	X-REP opt	
Serial output	RS485	RS485	RS485
Analog output	4÷20mA opt	4÷20mA opt	
Buzzer	pres	pres	pres
Real time clock			

**XR150C**

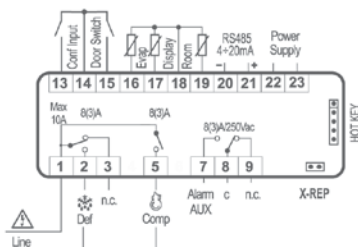

**XR160C**

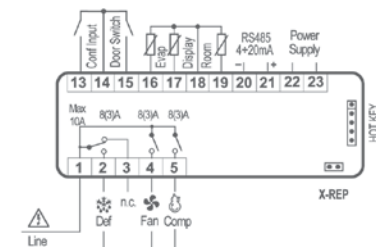

**XR160D**



# XR100

## MULTIFUNCTION CONTROLLERS with RS485 OUTPUT for MEDIUM and LOW TEMPERATURE



C: 32x74mm

D: 4 DIN Rail

<b>XR170C XR170D</b>	Digital controllers for M.T. and L.T. for ventilated applications with door switch capability, auxiliary relay and built in RS485
<b>XR172C</b>	Digital controller for M.T. and L.T. for ventilated applications with door switch capability, auxiliary relay and built in RS485 for use with slave unit XR40SL
<b>XR40SL</b>	Slave module for XR172C controller with direct 230Vac power supply connection and 20A compressor relay

FEATURES	XR170C	XR170D	XR172C	XR40SL
<b>Display: n° digits</b>	± 3 d.p.	± 3 d.p.	± 3 d.p.	
<b>Power supply</b>	12, 24Vac/dc	110, 230Vac	da XR40SL	24, 110, 230Vac
<b>Probe inputs</b>				
Thermostat	NTC/PTC	NTC/PTC	NTC/PTC	
Defrost	NTC/PTC	NTC/PTC	NTC/PTC	
Display	NTC/PTC	NTC/PTC	NTC/PTC	
<b>Digital inputs</b>				
Start defrost, pressure switch, energy saving, AUX, generic alarm, serious alarm mode	config	config	config	
Door switch	pres	pres	pres	
<b>Relay outputs</b>				
Compressor	8A	8A		20A
Defrost	8A	no 8A / nc 5A		16A
Fans	8A	8A		8A
Alarm	8A	16A		8A
<b>Other</b>				
Hot Key/Prog Tool Kit output	pres	pres	pres	
Remote display output	X-REP opt		X-REP opt	
Serial output	RS485	RS485	RS485	
Analog output	4÷20mA opt		4÷20mA opt	
Buzzer	pres	pres	pres	
Real time clock				

XR170C

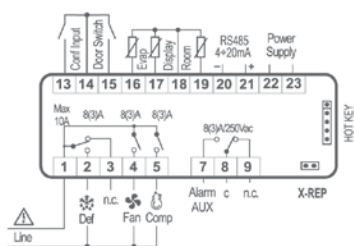

XR170D

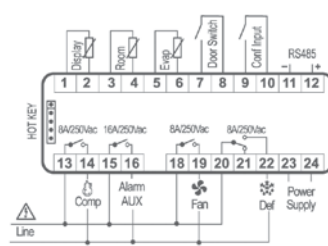

XR172C

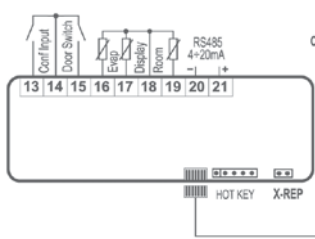

XR40SL

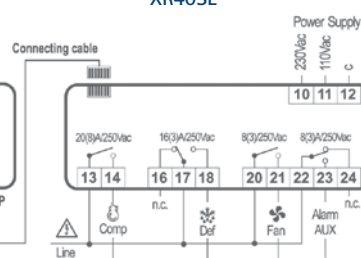

# XR500

## MULTIFUNCTION CONTROLLERS with RS485 OUTPUT and REAL TIME CLOCK for NORMAL, MEDIUM and LOW TEMPERATURE



C: 32x74mm

D: 4 DIN Rail

**XR530C**  
**XR530D**

Digital controllers for N.T. with "off cycle" defrost, additional configurable relay, built in RS485 and internal real time clock

**XR563D**

Digital controller for M.T. and L.T. ventilated applications with door switch capability, light relay, built in RS485 and internal real time clock

FEATURES	XR530C	XR530D	XR563D
<b>Display: n° digits</b>	± 3 d.p.	± 3 d.p.	± 3 d.p.
<b>Power supply</b>	12, 24Vac/dc	110,230Vac	110, 230Vac
<b>Probe inputs</b>			
Thermostat	NTC/PTC	NTC/PTC	NTC/PTC
Defrost			NTC/PTC
Display	NTC/PTC	NTC/PTC	NTC/PTC
<b>Digital inputs</b>			
Start defrost, pressure switch, energy saving, AUX, generic alarm, serious alarm mode	config	config	config
Door switch (light for XR563D)	pres	pres	pres
<b>Relay outputs</b>			
Compressor	8A	8A	8A
Defrost			no 8A / nc 5A
Fans			8A
Alarm (light for XR563D)	16A	16A	16A
<b>Other</b>			
Hot Key/Prog Tool Kit output	pres	pres	pres
Remote display output	X-REP opt		
Serial output	RS485	RS485	RS485
Analog output	4÷20mA opt		
Buzzer	pres	pres	pres
Real time clock	pres	pres	pres

**XR530C**

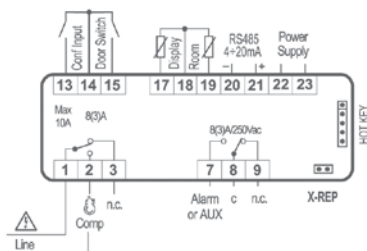

**XR530D**

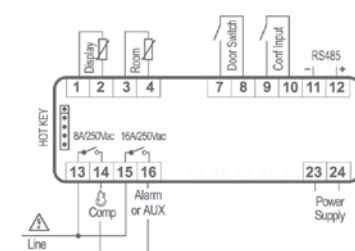

**XR563D**



# XR500

## MULTIFUNCTION CONTROLLERS with RS485 OUTPUT and REAL TIME CLOCK for MEDIUM and LOW TEMPERATURE



C: 32x74mm

D: 4 DIN Rail

<b>XR570C XR570D</b>	Digital controllers for M.T. and L.T. for ventilated applications with door switch capability, auxiliary relay, built in RS485 and internal real time clock
<b>XR572C</b>	Digital controller for M.T. and L.T. for ventilated applications with door switch capability, auxiliary relay, built in RS485 and internal real time clock for use with slave unit XR40SL
<b>XR40SL</b>	Slave module to be connected to XR572C controller with direct 230Vac power supply connection and 20A compressor relay

FEATURES	XR570C	XR570D	XR572C	XR40SL
<b>Display: n° digits</b>	± 3 d.p.	± 3 d.p.	± 3 d.p.	
<b>Power supply</b>	12, 24Vac/dc	110, 230Vac	da XR40SL	24, 110, 230Vac
<b>Probe inputs</b>				
Thermostat	NTC/PTC	NTC/PTC	NTC/PTC	
Defrost	NTC/PTC	NTC/PTC	NTC/PTC	
Display	NTC/PTC	NTC/PTC	NTC/PTC	
<b>Digital inputs</b>				
Start defrost, pressure switch, energy saving, AUX, generic alarm, serious alarm mode	config	config	config	
Door switch	pres	pres	pres	
<b>Relay outputs</b>				
Compressor	8A	8A		20A
Defrost	8A	no 8A / nc 5A		16A
Fans	8A	8A		8A
Alarm	8A	16A		8A
<b>Other</b>				
Hot Key/Prog Tool Kit output	pres	pres	pres	
Remote display output	X-REP opt		X-REP opt	
Serial output	RS485	RS485	RS485	
Analog output	4÷20mA opt		4÷20mA opt	
Buzzer	pres	pres	pres	
Real time clock	pres	pres	pres	

XR570C

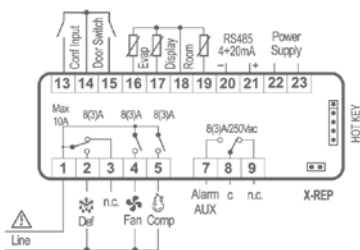

XR570D

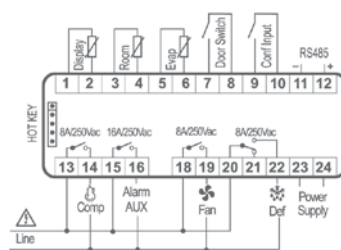

XR572C

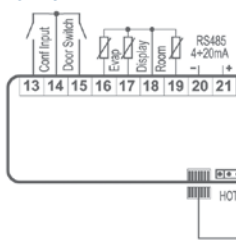

XR40SL

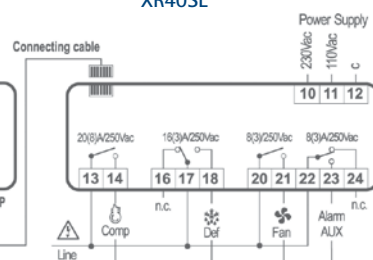



C: 32x74mm



S: 31x64mm



C: 32x74mm



28x48mm

## THERMOMETER: LCD & LED THERMOMETERS

- Measurement unit integrated on the display (XA100C)
- Hot Key or Prog Tool Kit connector for a quick and easy programming (XA100C)
- 3VA max power absorption (S-C formats)
- Display with red LED 11,5mm high (S format) and 13,2mm high (C format)

### HOW TO ORDER

XT11S [X][T][1][1][S][-][A][B][C][O][N]  For blue display please contact Dixell

A	B	C
<b>Power supply</b>	<b>Digits n° - measurement unit</b>	<b>Display update delay</b>
0 = 12Vac/dc 1 = 24Vac/dc 4 = 110Vac 5 = 230Vac	0 = °C - integer 1 = °F - integer 2 = °C - decimal point	0 = no delay 1 = 1 min 2 = 3 min

XR100C [X][R][1][0][0][C][-][A][B][O][D][O]  For blue display please contact Dixell

A	B	D
<b>Power supply</b>	<b>Input</b>	<b>Measurement unit</b>
0 = 12Vac/dc 1 = 24Vac/dc 4 = 110Vac 5 = 230Vac	0 = PTC N = NTC	C = °C F = °F

XA100C [X][A][1][0][0][C][-][A][B][O][D][U]  For blue display please contact Dixell

A	B	D
<b>Power supply</b>	<b>Measurement unit</b>	<b>Input</b>
0 = 12Vac/dc 1 = 24Vac/dc 4 = 110Vac 5 = 230Vac	C = °C F = °F B = Bar P = PSI H = %RH N = No measurement unit	P = PTC (NTC) T = PTC (NTC, Pt100, TcJ, TcK, TcS) A = 4±20mA, 0÷1V, 0÷10V B = PP07 (-0.5÷7bar) C = PP30 (0÷30bar) D = PP11 (-0.5÷11bar) H = XH10/20P

# THERMOMETER

## THERMOMETER with LIQUID CRYSTAL DISPLAY and LED THERMOMETERS



28x48mm

S: 31x64mm

C: 32x74mm

<b>LC11</b>	Liquid crystal thermometer – white or black colour available
<b>XT11S</b>	Digital thermometer with max and min log, powered directly by main voltage. Accessories: PB-KIT
<b>XR100C</b>	Digital thermometer powered directly by main voltage
<b>XA100C</b>	Configurable digital indicators

FEATURES	LC11	XT11S	XR100C	XA100C
<b>Display: n° digits</b>	± 3 LCD	± 3 d.p.	± 3 d.p.	± 3 d.p.
<b>Power supply</b>	battery – 24 month duration	12, 24Vac/dc	12, 24Vac/dc	12, 24Vac/dc
<b>Measurement range</b>	-40÷50°C -40÷122°F	110, 230Vac -40÷110°C -40÷230°F	110, 230Vac probe dependent	110, 230Vac probe dependent
<b>Inputs</b>				
Probe	NTC included	NTC included	NTC/PTC	NTC, PTC, Pt100 TcJ, TcK, TcS 4÷20mA, 0÷1V, 0÷10V
<b>Other</b>				
Hot Key/Prog Tool Kit output				pres
Digital input				pres
Serial output				TTL
Buzzer				opt
Offset adjustment		back side trimmer		via keyboard

XT11S

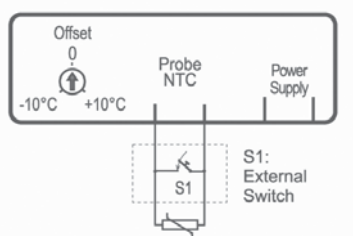

XR100C

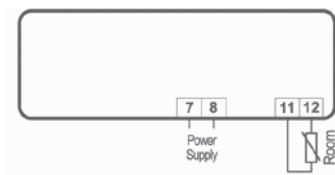

XA100C

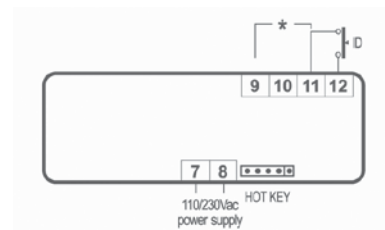

\* 4÷20mA, 0÷1V, 0÷10V=9(In); 11(gnd); 10(+)  
\* Pt100=9 - 11(10) \*NTC, PTC=9(In); 10(gnd)  
\* TcK, TcJ, TcS=9(+)- 11(-)

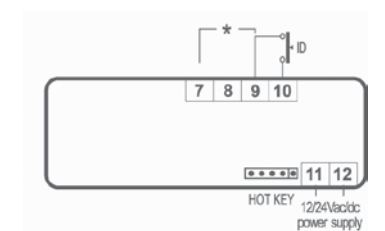

\* 4÷20mA, 0÷1V, 0÷10V=7(In); 9(gnd); 8(+)  
\* Pt100=7 - 9(8) \*NTC, PTC=7(In); 8(gnd)  
\* TcK, TcJ, TcS=7(+)- 9(-)





## WING REFRIGERATION CONTROLLERS

### SECTION INDEX

FUNCTIONS	MODELS	
<b>WING BASIC - NT, MT and LT applications – compact/split format</b>		<b>66</b>
Thermostats and "off cycle" defrost multifunction controllers	XW10L - XW10V - XW20L - XW20LS - XW20V - XW20VS - XW20K	68
Multifunction controllers for N.T. – M.T. – L.T.	XW35VS - XW40L - XW40LS - XW40V - XW40K	69
Multifunction controllers for M.T. – L.T.	XW60L - XW60LS - XW60V - XW60VS - XW60K - XW70L	70
Keyboards for multifunction controllers in K format	CX620 - T620 - V620	72
<b>WING 200/500 - NT, MT and LT applications – compact/split format – RS485 output</b>		<b>73</b>
"off cycle" defrost advanced multifunction controllers	XW220L - XW220K	74
Advanced multifunction controllers for N.T.	XW230L - XW230K	74
Advanced multifunction controllers for M.T. – L.T.	XW260L - XW260K - XW263L - XW264L - XW264K XW270L - XW270K - XW271L - XW271K - XW272K	75 76
Advanced multifunction controllers with real time clock for M.T. – L.T.	XW563L - XW570L - XW570K	77
Keyboards for advanced multifunction controllers in K format	T620 - V620 - T820 - V820 - T821 - V821 - T850 - V850	78



## WING BASIC SERIES: CONTROLLERS FOR NT, MT AND LT APPLICATIONS - COMPACT/SPLIT FORMAT

- Multifunction WING BASIC series dedicated to N.T. and L.T. refrigerated applications
- Innovative and elegant design that enhances the aesthetics and functionality of the final product
- Direct live and neutral load connections for reduction of wiring costs
- Display with icons and integrated measurement units (L and CX formats)
- Direct driving of compressors up to 1,2HP (20A relay inside)
- Direct line power supply. No external transformer required
- Up to 8 push buttons with direct action for user friendly interface
- Maximum and minimum temperature recording
- Energy saving cycle through digital input (L and K formats)
- Continuous cycle with a dedicated set point (L and K formats)
- Virtual probe management (L and K formats)
- Hot Key connector for a quick and easy programming
- Connection for X-REP remote display (L and K formats, for LS format is an alternative to TTL output)
- Serial connection to monitoring systems (L, LS and K formats)
- 7VA max power absorption
- Display with red LED (10,5mm high) and icons (L, LS and CX formats), 13,2mm high (VS and V formats)



LS/VS formats are the ideal solution for OEM applications with a reduced space

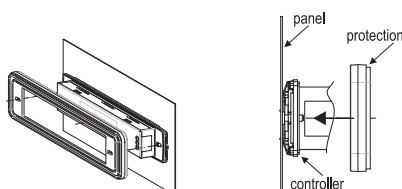

Horizontal controllers are available also in a back-panel mounting version



L format is provided with a wide display with integrated icons of the real time situation and the measurement unit, for clear and continuous monitoring

## HOW TO ORDER

WING L [X] [W] [ ] [ ] [L] [-] [A] [B] [C] [D] [E] [-] [N]



For inox version and blue display please contact Dixell

A	B	C	D	E
<b>Power supply</b> 2 = 24Vac 4 = 110Vac 5 = 230Vac	<b>Input</b> N NTC P PTC L NTC M PTC Q NTC R PTC	<b>Light relay</b> 8A 8A 16A 16A 16A neon 16A neon	<b>Buzzer</b> 0 No 1 Yes 2 No 3 Yes	<b>RTC</b> No No Yes Yes
			<b>Measurement unit</b> C = °C F = °F	<b>Comp. output</b> 0 20A 1 20A
				<b>X-REP</b> No Yes

WING LS [X] [W] [ ] [ ] [L] [S] [-] [A] [B] [C] [D] [E] [-] [N]



For inox version and blue display please contact Dixell

A	B	C	D	E
<b>Power supply</b> 2 = 24Vac 4 = 110Vac 5 = 230Vac	<b>Input</b> N = NTC P = PTC	<b>Buzzer</b> 0 No 1 Yes 2 No 3 Yes	<b>RTC</b> No No Yes Yes	<b>Measurement unit</b> C = °C F = °F
				<b>X-REP (excludes TTL output)</b> 1 = No 2 = Yes

WING V [X] [W] [ ] [ ] [V] [-] [A] [B] [C] [D] [E]



For blue display please contact Dixell

WING VS [X] [W] [ ] [ ] [V] [S] [-] [A] [B] [C] [D] [O]



For blue display please contact Dixell

A	B	C	D	E
<b>Power supply</b> 2 = 24Vac 4 = 110Vac 5 = 230Vac	<b>Input</b> N = NTC P = PTC	<b>Buzzer</b> 0 = No 1 = Yes	<b>Measurement unit</b> C = °C F = °F	<b>Compressor output</b> 0 = 8A 1 = 20A

WING K [X] [W] [ ] [ ] [K] [-] [A] [B] [C] [D] [O]

A	B	C	D
<b>Power supply</b> 2 = 24Vac 4 = 110Vac 5 = 230Vac	<b>Input / light relay</b> N = NTC P = PTC L = NTC / 16A neon M = PTC / 16A neon	<b>Housing</b> 0 = Open board "OS" 1 = Open board + 8 DIN Rail base 2 = 8 DIN Rail 3 = "GS" housing	<b>Measurement unit</b> C = °C F = °F

T,V KEYBOARDS [ ] [ ] [ ] [ ] [-] [A] [O] [O] [D] [O]



For inox version and blue display please contact Dixell

CX KEYBOARD [C] [X] [ ] [ ] [ ] [-] [A] [O] [O] [N] [O]



For blue display please contact Dixell

A	D
<b>Buzzer</b> 0 = No 1 = Yes	<b>Measurement unit</b> C = °C F = °F

# WING BASIC

## THERMOSTATS and "OFF CYCLE" DEFROST MULTIFUNCTION CONTROLLERS



L, LS: 38x185mm V, VS: 100x64mm K: OS/GS/8 DIN Rail

**XW10L**  
**XW10V**

Digital thermostats for heating or cooling applications, with light relay

**XW20L**  
**XW20LS**  
**XW20V**  
**XW20VS**  
**XW20K**

Digital controllers for N.T. applications with "off cycle" defrost and light relay

FEATURES	XW10L	XW10V	XW20L	XW20LS	XW20V	XW20VS	XW20K
<b>Display: n° digits</b>	± 3 d.p.	± 3 d.p.	± 3 d.p.	± 3 d.p.	± 3 d.p.	± 3 d.p.	on keyboard ± 3 d.p.
<b>Keyboard: push buttons</b>	6	6	6	6	6	6	CX620 - T620 - V620: 6
<b>Power supply</b>	24, 110, 230Vac	24, 110, 230Vac	24, 110, 230Vac	24, 110, 230Vac	24, 110, 230Vac	24, 110, 230Vac	24, 110, 230Vac
<b>Probe inputs</b>							
Thermostat	NTC/PTC	NTC/PTC	NTC/PTC	NTC/PTC	NTC/PTC	NTC/PTC	NTC/PTC
Defrost				NTC/PTC			
Condenser	NTC/PTC		NTC/PTC				NTC/PTC
Display	NTC/PTC		NTC/PTC			NTC/PTC	NTC/PTC
<b>Digital inputs</b>							
Alarm, start defrost, door switch, pressure switch	config	config	config	config*	config	config	config
DI 2	config		config				
<b>Relay outputs</b>							
Compressor	20A	8A, 20A opt	20A	20A	8A, 20A opt	16A	20A
Defrost							
Fans							
Light, ON/OFF	8A, 16A opt	16A	8A, 16A opt	8A	16A	16A	16A
Alarm, AUX							
<b>Other</b>							
Hot Key/Prog Tool Kit output	pres	pres	pres	pres	pres	pres	pres
Serial output	TTL		TTL	TTL			TTL
Remote display output	X-REP opt		X-REP opt	X-REP opt			
Buzzer	opt	opt	opt	opt	opt	opt	on keyboard
Real time clock	opt		opt	opt			

\*: configurabile also as a probe

**XW10L**  
**XW20L**

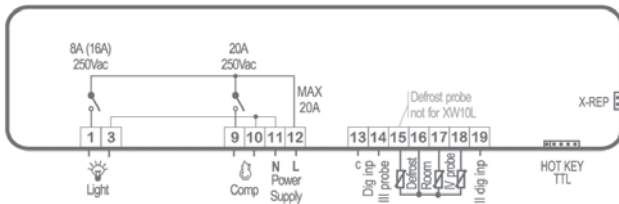

**XW20LS**

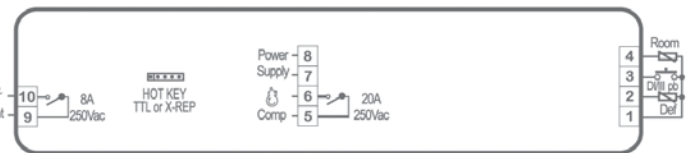

**XW10V**  
**XW20V**

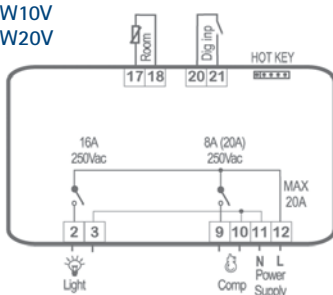

**XW20VS**

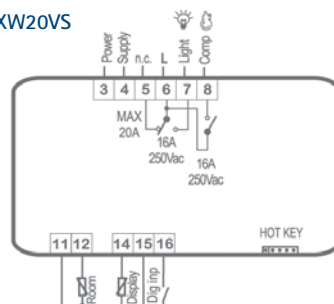

**XW20K**

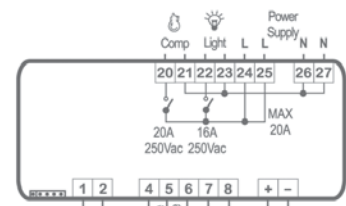

# WING BASIC

## MULTIFUNCTION CONTROLLERS for NORMAL, MEDIUM and LOW TEMPERATURE



L, LS: 38x185mm V, VS: 100x64mm K: OS/GS/8 DIN Rail

**XW35VS**

Digital controller for N.T. applications with "off cycle" defrost, light relay and fans

**XW40L  
XW40LS  
XW40V  
XW40K**

Digital controllers for M.T. and L.T. with electrical or hot gas defrost function and light relay

FEATURES	XW35VS	XW40L	XW40LS	XW40V	XW40K
<b>Display: n° digits</b>	± 3 d.p.	± 3 d.p.	± 3 d.p.	± 3 d.p.	on keyboard ± 3 d.p.
<b>Keyboard: push buttons</b>	6	6	6	6	CX620 - T620 - V620: 6
<b>Power supply</b>	24, 110, 230Vac	24, 110, 230Vac	24, 110, 230Vac	24, 110, 230Vac	24, 110, 230Vac
<b>Probe inputs</b>					
Thermostat	NTC/PTC	NTC/PTC	NTC/PTC	NTC/PTC	NTC/PTC
Defrost		NTC/PTC	NTC/PTC	NTC/PTC	NTC/PTC
Condenser		NTC/PTC			NTC/PTC
Display	NTC/PTC	NTC/PTC			NTC/PTC
<b>Digital inputs</b>					
Alarm, start defrost, door switch, pressure switch	config	config	config*	config	config
DI 2		config			
<b>Relay outputs</b>					
Compressor	16A	20A	20A	8A, 20A opt	20A
Defrost		8A	8A	8A	16A
Fans	8A				
Light, ON/OFF	16A	8A, 16A opt	8A	16A	16A
Alarm, AUX					
<b>Other</b>					
Hot Key/Prog Tool Kit output	pres	pres	pres	pres	pres
Serial output		TTL	TTL		TTL
Remote display output		X-REP opt	X-REP opt		
Buzzer	opt	opt	opt	opt	on keyboard
Real time clock		opt	opt		

\*: configurabile also as a probe

### XW40L

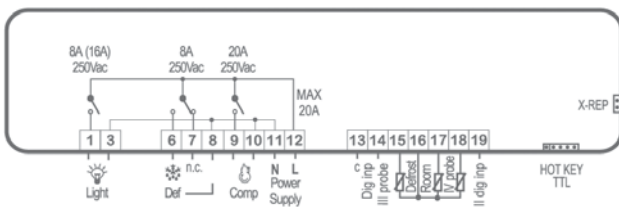

### XW40LS

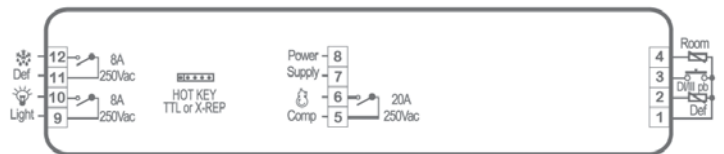

### XW35VS

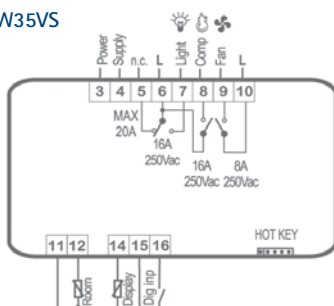

### XW40V

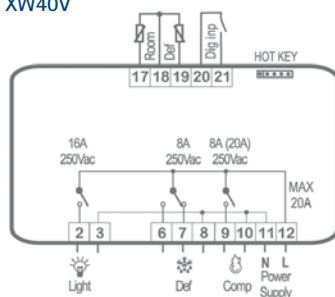

### XW40K

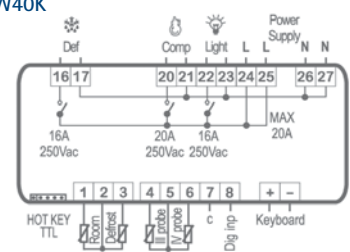

# WING BASIC

## MULTIFUNCTION CONTROLLERS for MEDIUM and LOW TEMPERATURE



XW60L  
XW60LS  
XW60V

Digital controllers for M.T. and L.T. for ventilated applications

L, LS: 38x185mm

V: 100x64mm

FEATURES	XW60L	XW60LS	XW60V
<b>Display: n° digits</b>	± 3 d.p.	± 3 d.p.	± 3 d.p.
<b>Keyboard: push buttons</b>	6	5	6
<b>Power supply</b>	24, 110, 230Vac	24, 110, 230Vac	24, 110, 230Vac
<b>Probe inputs</b>			
Thermostat	NTC/PTC	NTC/PTC	NTC/PTC
Defrost	NTC/PTC	NTC/PTC	NTC/PTC
Condenser	NTC/PTC		
Display	NTC/PTC		
<b>Digital inputs</b>			
Alarm, start defrost, door switch, pressure switch	config	config*	config
DI 2	config		
<b>Relay outputs</b>			
Compressor	20A	20A	8A, 20A opt
Defrost	8A	8A	8A
Fans	8A	8A	8A
Light, ON/OFF	8A, 16A opt		16A
Alarm, AUX			
<b>Other</b>			
Hot Key/Prog Tool Kit output	pres	pres	pres
Serial output	TTL	TTL	
Remote display output	X-REP opt	X-REP opt	
Buzzer	opt	opt	opt
Real time clock	opt	opt	

\*: configurabile also as a probe

### XW60L

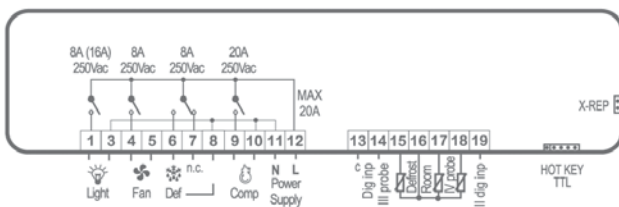

### XW60LS

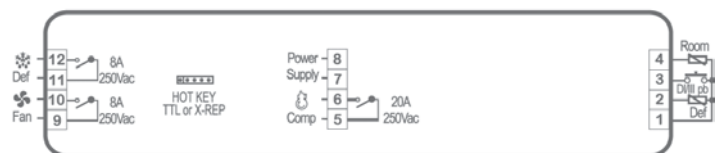

### XW60

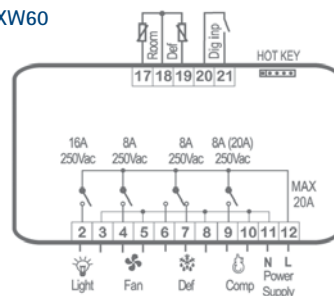

# WING BASIC

## MULTIFUNCTION CONTROLLERS for MEDIUM and LOW TEMPERATURE



L: 38x185mm VS: 100x64mm K: OS/GS/8 DIN Rail

**XW60VS**  
**XW60K**

Digital controllers for M.T. and L.T. for ventilated applications

**XW70L**

Digital controller for M.T. and L.T. for ventilated applications with light relay management and auxiliary relay output

FEATURES	XW60VS	XW60K	XW70L
<b>Display: n° digits</b>	± 3 d.p.	on keyboard ± 3 d.p.	± 3 d.p.
<b>Keyboard: push buttons</b>	5	CX620 - T620 - V620: 6	8
<b>Power supply</b>	24, 110, 230Vac	24, 110, 230Vac	24, 110, 230Vac
<b>Probe inputs</b>			
Thermostat	NTC/PTC	NTC/PTC	NTC/PTC
Defrost	NTC/PTC	NTC/PTC	NTC/PTC
Condenser		NTC/PTC	NTC/PTC
Display	NTC/PTC	NTC/PTC	NTC/PTC
<b>Digital inputs</b>			
Alarm, start defrost, door switch, pressure switch	config	config	config
DI 2			config
<b>Relay outputs</b>			
Compressor	16A	20A	20A
Defrost	16A	16A	8A
Fans	8A	8A	8A
Light, ON/OFF		16A	8A, 16A opt
Alarm, AUX			8A
<b>Other</b>			
Hot Key/Prog Tool Kit output	pres	pres	pres
Serial output		TTL	TTL
Remote display output			X-REP opt
Buzzer	opt	on keyboard	opt
Real time clock			opt

**XW60VS**

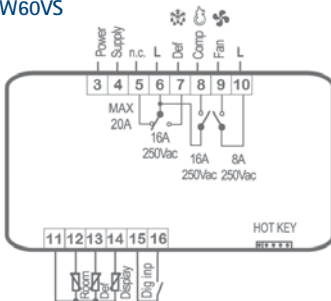

**XW70L**

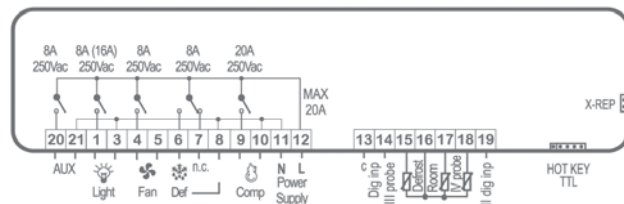

**XW60K**

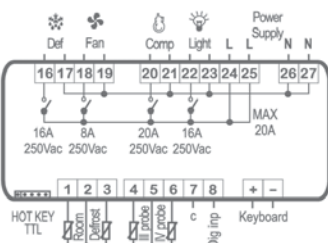

# WING BASIC

## KEYBOARDS for MULTIFUNCTION CONTROLLERS in K FORMAT



CX620  
T620  
V620

6 key keyboards for controllers in K format

FEATURES	CX620	T620	V620
Display: n° digits	± 3 d.p.	± 3 d.p.	± 3 d.p.
Keyboard: push buttons	6	6	6
Slave module	XW20K XW40K XW60K	XW20K XW40K XW60K	XW20K XW40K XW60K
Buzzer	opt	opt	opt



CX format is provided with a wide display with integrated icons of real time situation and measurement unit, for clear and continuous monitoring

### THE POWER MODULES IN K FORMAT ARE AVAILABLE IN 4 DIFFERENT VERSIONS:

**OS:** open board



**8 DIN Rail base:** open board with 8 DIN bottom



**GS:** with plastic housing 225x180x84mm



**8 DIN Rail:** with 8 DIN plastic housing







100x64mm



38x185mm



L: 38x185mm



L: 38x185mm

## WING 200/500 SERIES: CONTROLLERS FOR NT, MT AND LT APPLICATIONS – RS485 OUTPUT

- Advanced multifunction controllers for both heating and cooling applications
- Innovative and elegant design that enhances the aesthetics and functionality of the controller
- Direct load connections
- 20A compressor relay and neon light relay
- Up to 8 keys keyboard with direct access to the main functions
- Direct 230 (110)Vac power supply – No external transformer required
- Minimum and maximum temperature recording
- Standard communication protocol ModBUS-RTU
- Hot Key or Prog tool kit connector for a quick and easy programming
- 10VA max power absorption
- Display with red LED (13,2mm high)

### HOW TO ORDER

WING L  X  W     L -  A  B  C  D  E



A	B	C	D	E			
<b>Power supply</b> 4 = 110Vac 5 = 230Vac	<b>Input / light relay</b> N = NTC / standard L = NTC / neon	<b>Terminal blocks</b> 0 = Standard terminal blocks 1 = Disconnectable terminal blocks with screw	<b>Measurement unit</b> C = °C F = °F		<b>Built-in RS485</b>	<b>4÷20mA</b>	<b>X-REP</b>
				0	No	No	No
				1	No	No	Yes
				2	No	Yes	No
				3	No	Yes	Yes
				4	Yes	No	No
				5	Yes	No	Yes
				6	Yes	Yes	No
				7	Yes	Yes	Yes

KEYBOARDS     -  A  O  O  D  O



A	D
<b>Buzzer</b>	<b>Measurement unit</b>
0 = No 1 = Yes	C = °C F = °F

WING K  X  W     K -  A  B  C  D  E

A	B	C	D	E		
<b>Power supply</b> 4 = 110Vac 5 = 230Vac	<b>Input / light relay</b> N = NTC / standard L = NTC / neon	<b>Housing</b> 0 = Open board "OS" 1 = Cover in aluminium "OA" 2 = "GS" housing 182x142x76mm 3 = "PS" housing 4 = "GS" housing 225x180x84mm	<b>Measurement unit</b> C = °C F = °F		<b>Built-in RS485</b>	<b>4÷20mA</b>
				0	No	No
				2	No	Yes
				4	Yes	No
				6	Yes	Yes

# WING 200

## "OFF CYCLE" DEFROST ADVANCED MULTIFUNCTION CONTROLLERS for NORMAL TEMPERATURE



L: 38x185mm



K: 05/0A/GS/PS

XW220L  
XW220K

Multifunction digital controllers for N.T. with "off cycle" defrost

XW230L  
XW230K

Multifunction digital controllers for N.T. with "off cycle" defrost, auxiliary and alarm outputs

FEATURES	XW220L	XW220K	XW230L	XW230K
<b>Display: n° digits</b>	± 3 d.p.	on keyboard ± 3 d.p.	± 3 d.p.	on keyboard ± 3 d.p.
<b>Keyboard: push buttons</b>	6	T620 – V620: 6	8	T820 – V820: 8
<b>Power supply</b>	110, 230Vac	110, 230Vac	110, 230Vac	110, 230Vac
<b>Probe inputs</b>				
Thermostat	NTC	NTC	NTC	NTC
Defrost				
Display	NTC	NTC	NTC	NTC
<b>Digital inputs</b>				
Alarm, block alarm, pressure switch, start defrost, energy saving, ON/OFF, AUX, holiday	config	config	config	config
Door switch	pres	pres	pres	pres
<b>Relay outputs</b>				
Compressor	20A	20A	20A	20A
Compressor 2				
Defrost				
Defrost 2				
Fans				
ON/OFF				
Light	16A, 16A neon opt	16A, 16A neon opt	16A, 16A neon opt	16A, 16A neon opt
Alarm			8A	8A
Auxiliary			16A	16A
<b>Other</b>				
Hot Key/Prog Tool Kit output	pres	pres	pres	pres
Remote display output	X-REP opt		X-REP opt	
Serial output	TTL, RS485 opt	TTL, RS485 opt	TTL, RS485 opt	TTL, RS485 opt
Analog output	4÷20mA opt		4÷20mA opt	
Buzzer	pres	on keyboard opt	pres	on keyboard opt
Real time clock				

XW220L

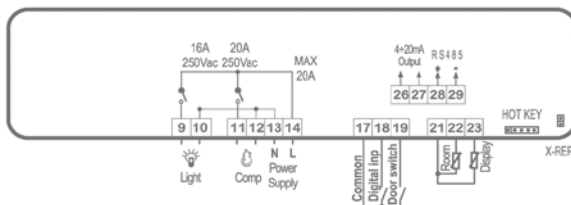

XW220K

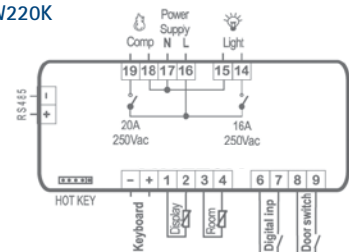

XW230L

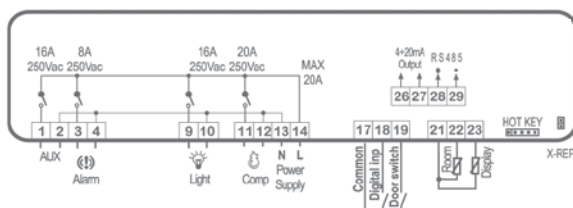

XW230K

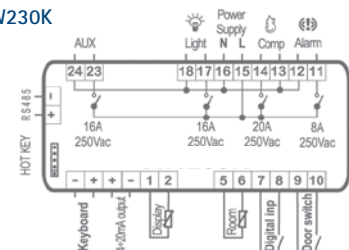

# WING 200

## ADVANCED MULTIFUNCTION CONTROLLERS for MEDIUM and LOW TEMPERATURE



L: 38x185mm



K: OS/OA/GS/PS

**XW260L**  
**XW260K**

Multifunction digital controllers for M.T. and L.T. ventilated applications

**XW263L**

Multifunction digital controller for M.T. and L.T. ventilated applications with 16A defrost standard relay

**XW264L**  
**XW264K**

Multifunction digital controllers for M.T. and L.T. ventilated applications with double evaporator management

FEATURES	XW260L	XW260K	XW263L	XW264L	XW264K
<b>Display: n° digits</b>	± 3 d.p.	on keyboard ± 3 d.p.	± 3 d.p.	± 3 d.p.	on keyboard ± 3 d.p.
<b>Keyboard: push buttons</b>	6	T620 – V620: 6	6	6	T620 – V620: 6
<b>Power supply</b>	110, 230Vac	110, 230Vac	110, 230Vac	110, 230Vac	110, 230Vac
<b>Probe inputs</b>					
Thermostat	NTC	NTC	NTC	NTC	NTC
Defrost	NTC	NTC	NTC	NTC	NTC
Display (defrost 2 for XW264)	NTC	NTC		NTC	NTC
<b>Digital inputs</b>					
Alarm, block alarm, pressure switch, start defrost, energy saving, ON/OFF, AUX, holiday	config	config	config	config	config
Door switch	pres	pres	pres	pres	pres
<b>Relay outputs</b>					
Compressor	20A	20A	8A	20A	8A
Compressor 2					
Defrost	8A	8A	16A	8A	8A
Defrost 2				8A	8A
Fans	8A	8A	8A	8A	8A
ON/OFF				16A	16A
Light	16A, 16A neon opt	16A, 16A neon opt	16A, 16A neon opt	16A, 16A neon opt	16A, 16A neon opt
Alarm					
Auxiliary					
<b>Other</b>					
Hot Key/Prog Tool Kit output	pres	pres	pres	pres	pres
Remote display output	X-REP opt			X-REP opt	
Serial output	TTL, RS485 opt	TTL, RS485 opt	RS485	TTL, RS485 opt	TTL, RS485 opt
Analog output	4÷20mA opt	4÷20mA opt		4÷20mA opt	4÷20mA opt
Buzzer	pres	on keyboard opt	pres	pres	on keyboard opt
Real time clock					

**XW260L**

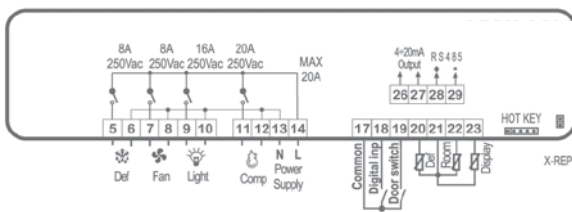

**XW263L**

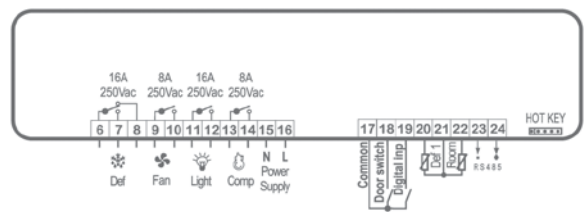

**XW260K**

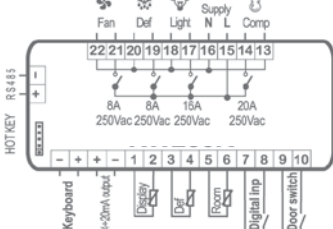

**XW264L**

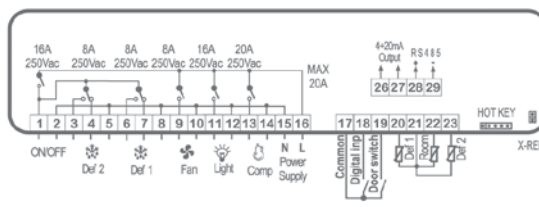

**XW264K**

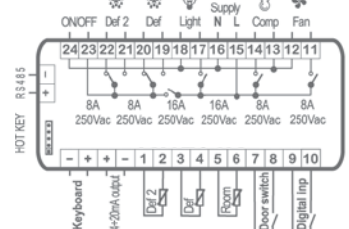

# WING 200

## ADVANCED MULTIFUNCTION CONTROLLERS for MEDIUM and LOW TEMPERATURE



L: 38x185mm



K: 05/0A/GS/PS

**XW270L  
XW270K**

Multifunction digital controllers for M.T. and L.T. ventilated applications with auxiliary relay output

**XW271L  
XW271K**

Multifunction digital controllers for M.T. and L.T. ventilated applications with anti condensing heater relay output

**XW272K**

Multifunction digital controller for M.T. and L.T. ventilated applications with twin compressors management

FEATURES	XW270L	XW270K	XW271L	XW271K	XW272K
<b>Display: n° digits</b>	± 3 d.p.	on keyboard ± 3 d.p.	± 3 d.p.	on keyboard ± 3 d.p.	on keyboard ± 3 d.p.
<b>Keyboard: push buttons</b>	8	T820 – V820: 8	8	T821 – V821: 8	T620 – V620: 6
<b>Power supply</b>	110, 230Vac	110, 230Vac	110, 230Vac	110, 230Vac	110, 230Vac
<b>Probe inputs</b>					
Thermostat	NTC	NTC	NTC	NTC	NTC
Defrost	NTC	NTC	NTC	NTC	NTC
Display	NTC	NTC	NTC	NTC	NTC
<b>Digital inputs</b>					
Alarm, block alarm, pressure switch, start defrost, energy saving, ON/OFF, AUX, holiday	config	config	config	config	config
Door switch	pres	pres	pres	pres	pres
<b>Relay outputs</b>					
Compressor	20A	20A	20A	20A	20A
Compressor 2					20A
Defrost	8A	8A	8A	8A	8A
Defrost 2					
Fans	8A	8A	8A	8A	8A
ON/OFF					
Light	16A, 16A neon opt	16A, 16A neon opt	16A, 16A neon opt	16A, 16A neon opt	16A, 16A neon opt
Alarm	8A	8A	8A	8A	8A
Auxiliary	16A	16A	16A*	16A*	
<b>Other</b>					
Hot Key/Prog Tool Kit output	pres	pres	pres	pres	pres
Remote display output	X-REP opt		X-REP opt		
Serial output	TTL, RS485 opt	TTL, RS485 opt	TTL, RS485 opt	TTL, RS485 opt	TTL, RS485 opt
Analog output	4÷20mA opt	4÷20mA opt	4÷20mA opt	4÷20mA opt	4÷20mA opt
Buzzer	pres	on keyboard opt	pres	on keyboard opt	on keyboard opt
Real time clock					

\*: on XW271K the auxiliary relay is anti-condensing heater

### XW270L – XW271L

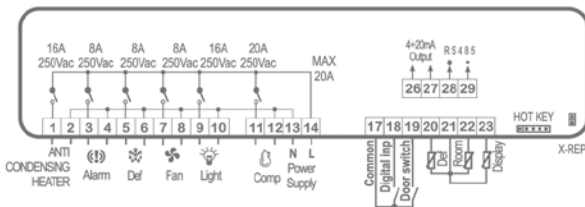

### XW270K – XW271K

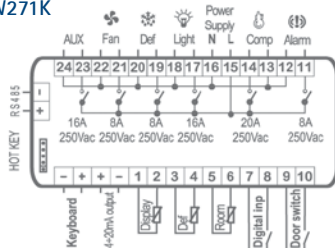

### XW272K

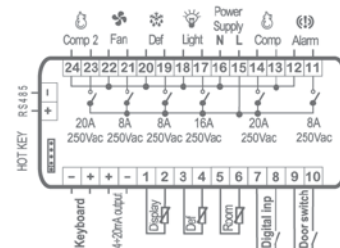

# WING 500

## ADVANCED MULTIFUNCTION CONTROLLERS with REAL TIME CLOCK for MEDIUM and LOW TEMPERATURE



L: 38x185mm



K: OS/OA/GS/PS

**XW563L**

Multifunction digital controller for M.T. and L.T. ventilated applications with internal real time clock

**XW570L  
XW570K**

Multifunction digital controllers for M.T. and L.T. ventilated applications with internal real time clock and auxiliary relay output

FEATURES	XW563L	XW570L	XW570K
<b>Display: n° digits</b>	± 3 d.p.	± 3 d.p.	on keyboard ± 3 d.p.
<b>Keyboard: push buttons</b>	8	8	T850 - V850: 8
<b>Power supply</b>	110, 230Vac	110, 230Vac	110, 230Vac
<b>Probe inputs</b>			
Thermostat	NTC	NTC	NTC
Defrost	NTC	NTC	NTC
Display		NTC	NTC
<b>Digital inputs</b>			
Alarm, block alarm, pressure switch, start defrost, energy saving, ON/OFF, AUX, holiday	config	config	config
Door switch	pres	pres	pres
<b>Relay outputs</b>			
Compressor	8A	20A	20A
Compressor 2			
Defrost	16A	8A	8A
Defrost 2			
Fans	8A	8A	8A
ON/OFF			
Light	16A, 16A neon opt	16A, 16A neon opt	16A, 16A neon opt
Alarm		8A	8A
Auxiliary		16A	16A
<b>Other</b>			
Hot Key/Prog Tool Kit output	pres	pres	pres
Remote display output		X-REP opt	X-REP opt
Serial output	RS485	TTL, RS485 opt	TTL, RS485 opt
Analog output		4÷20mA opt	4÷20mA opt
Buzzer	pres	pres	pres
Real time clock	pres	pres	pres

**XW563L**

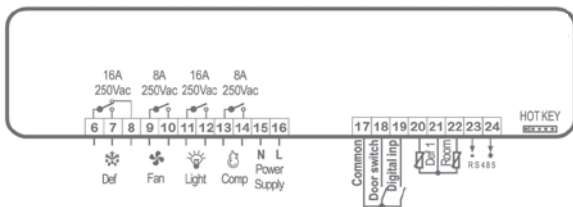

**XW570L**

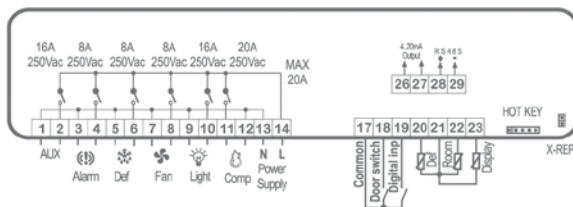

**XW570K**

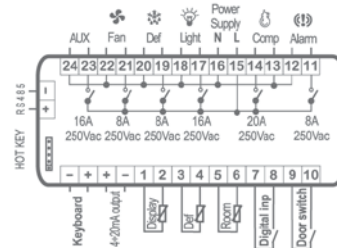

# WING 200/500

## KEYBOARDS for ADVANCED MULTIFUNCTION CONTROLLERS in K FORMAT



38x185mm



100x64mm

<b>T620 V620</b>	6 key keyboards for controllers in K format
<b>T820 V820</b>	8 key keyboards for controllers in K format
<b>T821 V821</b>	8 key keyboards for controllers in K format with key for anti-condensing heater
<b>T850 V850</b>	8 key keyboards for controllers in K format with real time clock

FEATURES	T620 - V620	T820 - V820	T821 - V821	T850 - V850
Display: n° digits	± 3 d.p.	± 3 d.p.	± 3 d.p.	± 3 d.p.
Keyboard: push buttons	6	8	8	8
Slave module	XW220K XW260K XW264K XW272K	XW230K XW270K	XW271K	XW570K
Buzzer	opt	opt	opt	opt

### THE POWER MODULES IN K FORMAT ARE AVAILABLE IN DIFFERENT VERSIONS:

**OS:** open board



**OA:** open board with aluminium protection



**GS:** standard case



**PS:** UL case





# HACCP REFRIGERATION CONTROLLERS

## SECTION INDEX

FUNCTIONS	MODELS	
<b>XR700-XW700</b> - NT, MT and LT applications – serial output		<b>80</b>
"off cycle" defrost controllers with HACCP function	XR720C - XW720L - XW720V	83
Controllers with HACCP function for M.T. - L.T.	XR740C - XW740L - XW740V - XR745C	
	XR760C - XW760L - XW760V - XR775C	84
<b>XDL</b> - NT, MT and LT applications		<b>86</b>
Temperature recording device	XDL01 - PW-DL - XJDL40D	86



V: 100x64mm



C: 32x74mm



L: 38x185mm



## XR700-XW700 SERIES: CONTROLLERS FOR NT, MT AND LT APPLICATIONS – SERIAL OUTPUT

- Advanced multifunction controllers with HACCP function
- Innovative and elegant design that enhances the aesthetics and functionality of the controller
- Monitoring, signaling and recording of the critical temperature
- Correct storage of products
- Direct 230Vac power supply
- Up to 4 relays and 2 digital inputs
- 6 keys keyboard with direct access to the main functions (WING format)
- Hand held infrared reader unit to download from the controllers all the data and to transfer them directly to a printer
- Hot Key or Prog tool kit connector for a quick and easy programming
- 4VA max power absorption
- Dual display with red LED (8,0mm high) and yellow LED (5,6mm high) and 14 icons

### HOW TO ORDER

XR700C [X] [R] [7] [ ] [ ] [C] [ - ] [A] [B] [O] [D] [E]



A	B	D	E
<b>Power supply</b>	<b>IR output</b>	<b>Measurement unit</b>	<b>RS485 output</b>
0 = 12Vac/dc 1 = 24Vac/dc 4 = 110Vac 5 = 230Vac	0 = No 1 = Yes	C = °C F = °F	0 = No 1 = Yes

XW700L/V [X] [W] [7] [ ] [ ] [ ] [ - ] [A] [B] [O] [D] [E]



A	B	D	E
<b>Power supply</b>	<b>Input / light relay</b>	<b>Measurement unit</b>	<b>Compressor output and IR</b>
4 = 110Vac 5 = 230Vac	N = NTC / standard L = NTC / neon	C = °C F = °F	0 = 8A 1 = 20A 2 = 8A + IR 3 = 20A + IR



DISPLAY ICONS	MEANING
°C	Celsius degrees
°F	Fahrenheit degrees
H!	High temperature alarm
L!	Low temperature alarm
! (with thermometer)	Critical temperature (minimum or maximum)
! (with square)	Digital input alarm
Book icon	Alarm list
Clock icon	Clock
Calendar icon	Date
WiFi icon	Infrared transmission
Menu	It signals "The function menu"
From	Start time
To	End time



### COMPLETE

The **dual display** with **14 icons** shows complete information about the status of the machine. Without the need to enter into the programming mode, all the main functioning of the cooling system is displayed with only one key touch.

## MAIN WINDOWS



### Normal operation

The controller displays temperature and time. The output status is monitored by small leds on the display.



### Temperature alarm

The controller displays the temperature and how far away it is from the set point.



### Book of alarms list

The last 20 alarms are recorded in the controller. The book icon flashing means that a new alarm has occurred. To see the alarm list press one of the HACCP buttons.



### Complete info of events

Book of Alarms List contains the record of previous alarms - type of alarm (eg., high temp, blackout etc.), times, duration, dates, critical temperatures reached.



### Safe and protected

A Security Code can be required for the following operations:

- reset alarm list;
- high/low alarm values modification;
- special functions.



```

<<<DIXELL>>>
ALARM LIST
ARCHIVES AVAILABLE: 01

* DEVICE N.01
* SET POINT      : -5.0°C
* LOW ALARM      : -15.0°C
* HIGH ALARM     : -0.5°C
* FROM          : 05-06-08 10:27
* TO            : 16-07-08 17:09
* ALARMS        : 04

01 - HIGH TEMPERATURE ALARM
FROM      : 13-07-08 11:27
TO        : 13-07-08 12:13
CRITICAL T : 04.6°C
DETECTED  : 13-07-08 12:02

02 - EXTERNAL ALARM
FROM      : 29-06-08 01:57
TO        : 29-06-08 02:23

03 - LOW TEMPERATURE ALARM
FROM      : 18-06-08 18:26
TO        : 18-06-08 18:53
CRITICAL T : -17.1°C
DETECTED  : 18-06-08 18:49

04 - EXTERNAL ALARM
FROM      : 08-06-08 08:40
TO        : 08-06-08 10:13

* END OF ALARM

End of printing
  
```

A typical report with alarms

An optional hand held infrared reader unit is available to download from controllers (up to 40) all the recorded data and to transfer them directly to a printer provided with IR port. A PC is not required.

## iPRINT: THE INFRARED FACILITY

### EG. HIGH TEMPERATURE ALARM

When a high (or low) temperature alarm occurs, instrument records the start ① and end time ②, the date and the maximum (or minimum) temperature ③ reached.

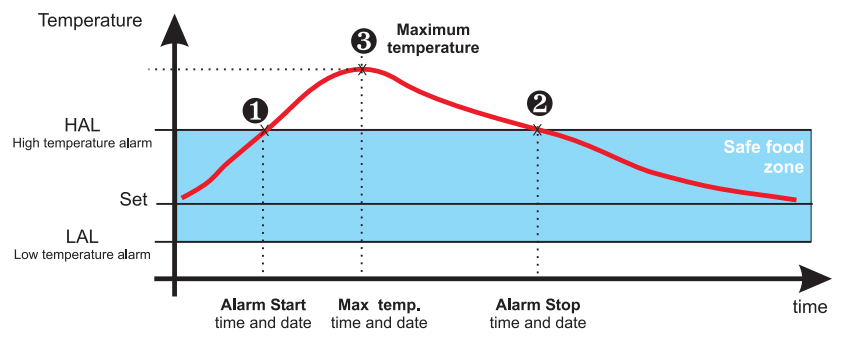

### BLACKOUT ALARM

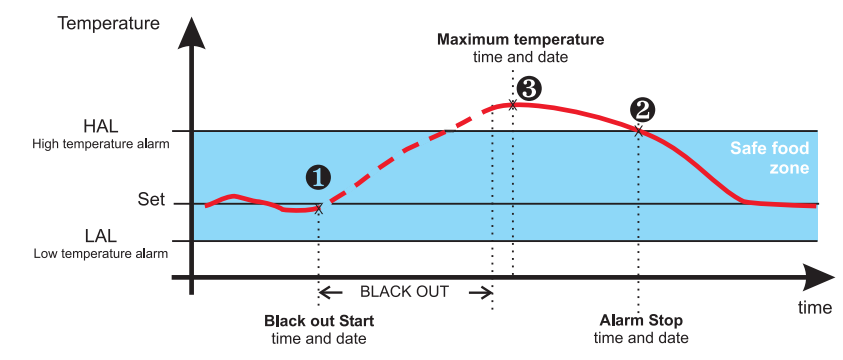

If, after a blackout, the temperature is higher than the alarm value, the start of the blackout ① and the end of alarm temperature ② together with the max temperature reached ③ are recorded.

# XR700-XW700

## "OFF CYCLE" DEFROST CONTROLLERS with HACCP FUNCTION



C: 32x74mm

L: 38x185mm

V: 100x64mm

XR720C  
XW720L  
XW720V

Digital controllers for N.T. with "off cycle" defrost

FEATURES	XR720C	XW720L	XW720V
<b>First display: n° digits</b>	± 3 d.p.	± 3 d.p.	± 3 d.p.
<b>Second display: n° digits</b>	± 4 d.p.	± 4 d.p.	± 4 d.p.
<b>Keyboard: push buttons</b>	4	6	6
<b>Power supply</b>	110, 230Vac	110, 230Vac	110, 230Vac
<b>Probe inputs</b>			
Thermostat	NTC	NTC	NTC
Defrost			
Display	NTC	NTC	NTC
<b>Digital inputs</b>			
Alarm, door switch, light, defrost	config	config	config
Door switch			
<b>Relay outputs</b>			
Compressor	8A	8A, 20A opt	8A, 20A opt
Defrost			
Fans			
Light		8A	16A
Light, alarm			
<b>Other</b>			
Hot Key/Prog Tool Kit output	pres	pres	pres
Serial output		TTL	TTL
Infrared output	opt	opt	opt
Buzzer	pres	pres	pres
Real time clock	pres	pres	pres

XR720C

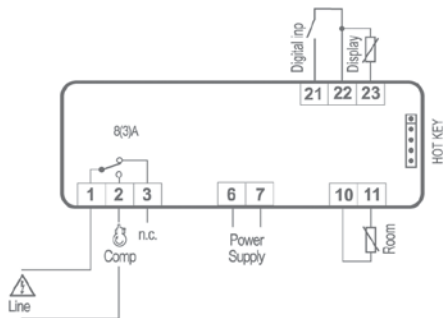

XW720L

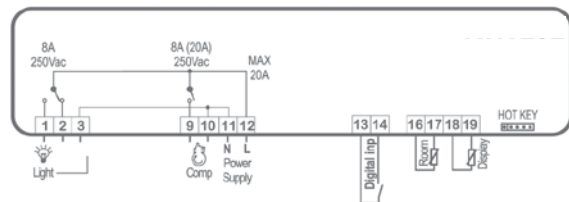

XW720V

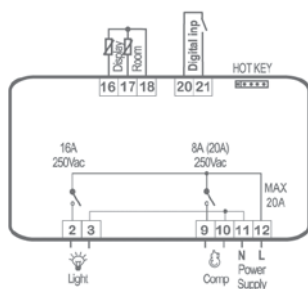

# XR700-XW700

## CONTROLLERS with HACCP FUNCTION for MEDIUM and LOW TEMPERATURE



C: 32x74mm

L: 38x185mm

V: 100x64mm

**XR740C**  
**XW740L**  
**XW740V**

Digital controllers for M.T and L.T. with defrost management

**XR745C**

Digital controller for M.T and L.T. with defrost management and RS485 serial output

FEATURES	XR740C	XW740L	XW740V	XR745C
<b>First display: n° digits</b>	± 3 d.p.	± 3 d.p.	± 3 d.p.	± 3 d.p.
<b>Second display: n° digits</b>	± 4 d.p.	± 4 d.p.	± 4 d.p.	± 4 d.p.
<b>Keyboard: push buttons</b>	4	6	6	4
<b>Power supply</b>	110, 230Vac	110, 230Vac	110, 230Vac	12, 24Vac/dc
<b>Probe inputs</b>				
Thermostat	NTC	NTC	NTC	NTC
Defrost	NTC	NTC	NTC	NTC
Display	NTC	NTC	NTC	NTC
<b>Digital inputs</b>				
Alarm, door switch, light, defrost	config	config	config	config
Door switch				pres
<b>Relay outputs</b>				
Compressor	8A	8A, 20A opt	8A, 20A opt	8A
Defrost	8A	8A	8A	8A
Fans				
Light		8A	16A	
Light, alarm				
<b>Other</b>				
Hot Key/Prog Tool Kit output	pres	pres	pres	pres
Serial output		TTL	TTL	TTL, RS485 opt
Infrared output	opt	opt	opt	opt
Buzzer	pres	pres	pres	pres
Real time clock	pres	pres	pres	pres

XR740C

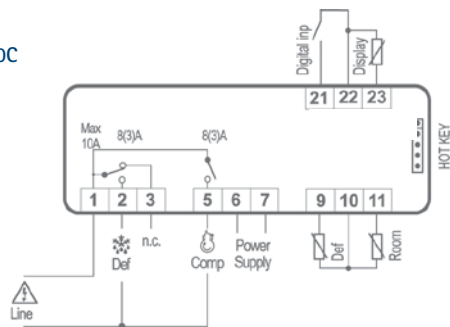

XW740L

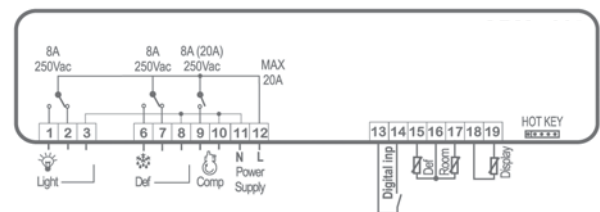

XW740V

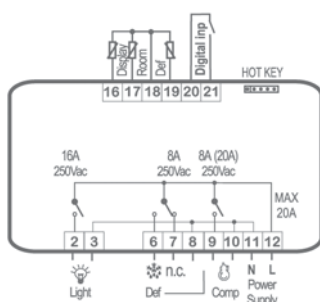

XR745C

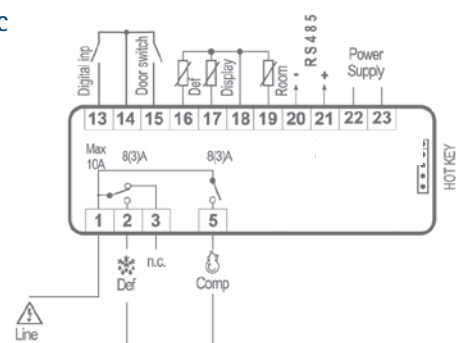

# XR700-XW700

## CONTROLLERS with HACCP FUNCTION for MEDIUM and LOW TEMPERATURE



C: 32x74mm

L: 38x185mm

V: 100x64mm

**XR760C**  
**XW760L**  
**XW760V**

Digital controllers for M.T. and L.T. ventilated applications

**XR775C**

Digital controller for M.T. and L.T. ventilated applications with RS485 serial output

FEATURES	XR760C	XW760L	XW760V	XR775C
<b>First display: n° digits</b>	± 3 d.p.	± 3 d.p.	± 3 d.p.	± 3 d.p.
<b>Second display: n° digits</b>	± 4 d.p.	± 4 d.p.	± 4 d.p.	± 4 d.p.
<b>Keyboard: push buttons</b>	4	6	6	4
<b>Power supply</b>	110, 230Vac	110, 230Vac	110, 230Vac	12, 24Vac/dc
<b>Probe inputs</b>				
Thermostat	NTC	NTC	NTC	NTC
Defrost	NTC	NTC	NTC	NTC
Display	NTC	NTC	NTC	NTC
<b>Digital inputs</b>				
Alarm, door switch, light, defrost	config	config	config	config
Door switch				pres
<b>Relay outputs</b>				
Compressor	8A	8A, 20A opt	8A, 20A opt	8A
Defrost	8A	8A	8A	8A
Fans	8A	8A	8A	8A
Light		8A	16A	
Light, alarm				8A config
<b>Other</b>				
Hot Key/Prog Tool Kit output	pres	pres	pres	pres
Serial output		TTL	TTL	TTL, RS485 opt
Infrared output	opt	opt	opt	opt
Buzzer	pres	pres	pres	pres
Real time clock	pres	pres	pres	pres

XR760C

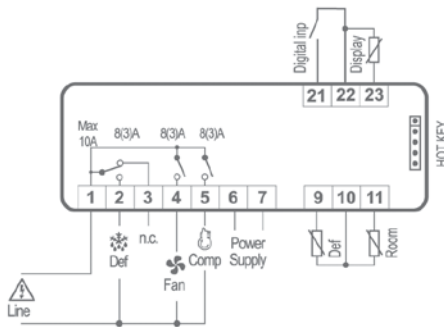

XW760L

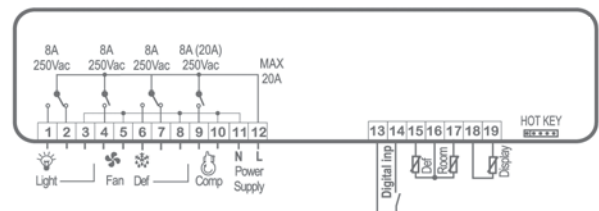

XW760V

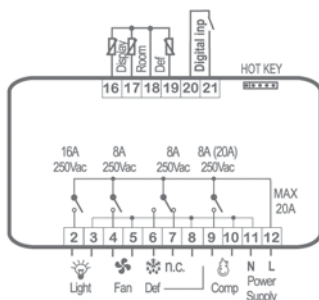

XR775C

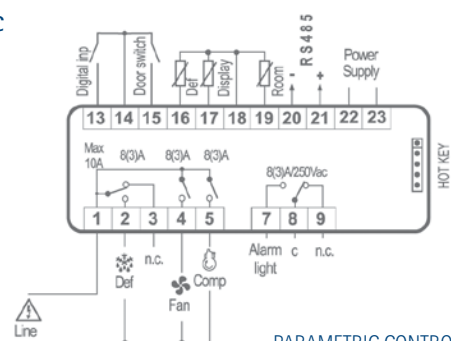



45x70mm

	A	B	C	D	E	F
1	DATE	PB1	PB2	PB3	PB4	STATUS
2	19/05/2008 11:34	-18.4	-25.8	—	—	ON/C
3	19/05/2008 11:44	-17.8	-25.8	—	—	ON/C
4	19/05/2008 11:54	-18.0	-25.6	—	—	ON/C
5	19/05/2008 12:04	—	—	—	—	OFF
6	19/05/2008 12:14	-18.5	-24.8	—	—	ON/C
7	19/05/2008 12:24	-17.7	-25.2	—	—	ON/C
8	19/05/2008 12:34	-18.0	-25.5	—	—	ON/C
9	19/05/2008 12:44	-18.4	-25.7	—	—	ON/C



## XDL SERIES: TEMPERATURE RECORDING DEVICE FOR NT, MT AND LT APPLICATIONS

- The XDL is a temperature and status recording module for refrigerating applications that works in accordance to HACCP rules. It works with Dixell instruments equipped with the serial output or combined with XJDL40D probe module. Monitoring of temperature, alarms and digital inputs is simple and intuitive, and data can be easily downloaded on a USB key
- Connection to Dixell controllers that are provided with serial output (through PW-DL)
- Stand-alone operation in a 4 DIN module (XJDL40D provided with 4 NTC probes, 4 DI and 1 relay output)
- Fast and simple mounting
- Recorded data download on a USB key: txt format that can also be displayed in EXCEL
- Data recording: up to 1 year with sampling up to 16 minutes (settable)
- TTL and RS485 inputs with internal converter (on PW-DL or XJDL40D)
- 4VA max power absorption
- Dual display with red LED (8,0mm high) and yellow LED (5,6mm high) and 13 icons

### XDL01 - PW-DL

The XDL01 data recording module is connected to PW-DL power supply that it's also an interface for Dixell instruments with TTL or RS485 serial output

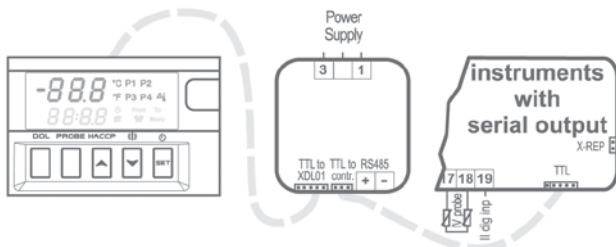

### XDL01 - XJDL40D

The XDL01 data recording module it's directly connected to the XJDL40D controller available in 4DIN format. The XJDL40D has 4 built-in digital inputs, one 8A relay output and 4 NTC probe inputs

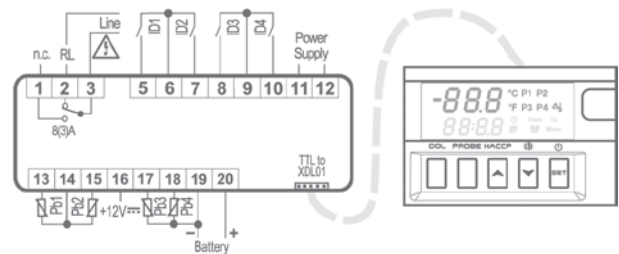

## HOW TO ORDER

XDL01 X D L 0 1 - 0 0 0 D 0

PW-DL P W - D L - A 0 0 0 0

XJDL40D X J D L 4 0 D - A B 0 D 0

A	B	D
<b>Power supply</b>	<b>Battery</b>	<b>Measurement unit</b>
2 = 24Vac 4 = 110Vac 5 = 230Vac	0 = No 1 = Yes	0 = °C decimal 1 = °C integer 2 = °F



# MULTIPLYED CABINET REFRIGERATION CONTROLLERS

## SECTION INDEX

FUNCTIONS	MODELS	
<b>XM - NT and LT applications - serial output</b>		<b>88</b>
Multiplexed cabinet controllers for N.T. - LT.	XM244L - XM440K	90
	XM460K - XM463K - XM470K	91
Advanced multifunction controllers for N.T. - LT. multiplexed cabinets	XM660K - XM669K - XM670K - XM679K	92
Keyboards for multiplexed cabinet controllers in K format	CX640- T640 - V640 - T840 - V840 - CX660	94



D: 10 DIN Rail



100x64mm



32x74mm



L: 38x185mm



38x185mm

## XM SERIES: CONTROLLERS FOR NT AND LT APPLICATIONS – SERIAL OUTPUT

- Multifunction controllers for multiplexed applications
- Multi-master devices (XM400/600)
- Each slave module can be driven and set through a unique keyboard held by the master unit (XM400/600)
- Up to 5 controllers linked for XM400 series and up to 8 for XM600 series
- Internal Real Time Clock
- Direct load connections (XM200/400)
- Up to 8 keys keyboard with direct access to the main functions
- Integrated electronic expansion valve drive (XM600)
- Anti-sweat heater management through a "DEW POINT" (XM600)
- Virtual probe management (XM600)
- Standard communication protocol ModBUS-RTU
- Hot Key or Prog tool kit connector for a quick and easy programming
- 10VA max power absorption
- Display with red LED (13,2 mm high), (10,5mm and icons for CX format)

## MULTIPLXED CABINET APPLICATIONS WITH CONTROLLERS IN K FORMAT

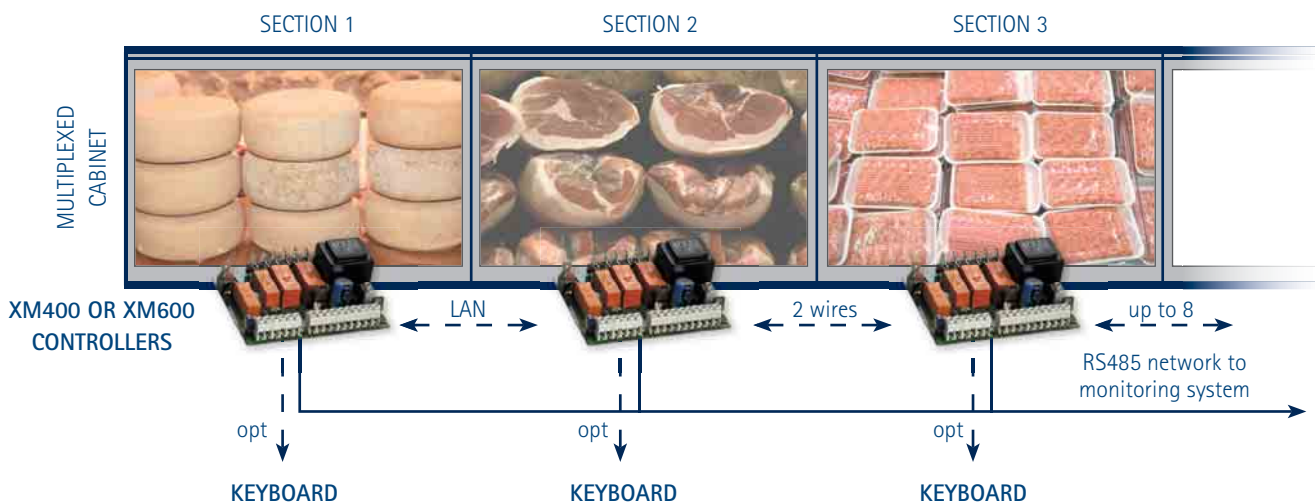



## HOW TO ORDER

XM200L

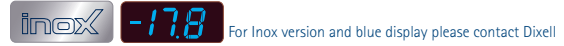

A	B	C	D
<b>Power supply</b>	<b>Real time clock</b>	<b>Buzzer</b>	<b>Measurement unit</b>
4 = 110Vac 5 = 230Vac	0 = No 1 = Yes	0 = No 1 = Yes	C = °C F = °F

T, V KEYBOARDS

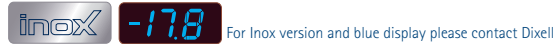

CX KEYBOARDS



A	D
<b>Buzzer</b>	<b>Measurement unit</b>
0 = No 1 = Yes	C = °C F = °F

XM400K

A	B	C	D	E
<b>Power supply</b>	<b>Real time clock</b>	<b>Housing</b>	<b>Measurement unit</b>	<b>Built-in RS485</b>
4 = 110Vac 5 = 230Vac	0 = No 1 = Yes	0 = Open board "OS" 1 = "GS" housing	C = °C F = °F	0 = No 1 = Yes

XM600K

A	B	C			D	E	
<b>Power supply</b>	<b>Input</b>	<b>RTC</b>	<b>RS485</b>	<b>Housing</b>	<b>Measurement unit</b>	<b>Modulating output</b>	<b>Connections</b>
0 = 12Vac/dc 2 = 24Vac 4 = 110Vac 5 = 230Vac 6 = 110÷230Vac	N = NTC/4÷20mA O = NTC/0÷10V P = Pt1000/4÷20mA Q = Pt1000/0÷10V	0 No 1 No 2 Yes 3 Yes 4 No 5 No 6 Yes 7 Yes	No Yes No Yes No Yes No Yes	8 DIN Rail 8 DIN Rail 8 DIN Rail 8 DIN Rail Open board Open board Open board Open board	C = °C/bar F = °F/psi	0 No 1 No 2 4÷20mA/0÷10V 3 4÷20mA/0÷10V 4 12V/30mA/PWM 5 12V/30mA/PWM	Discon+screw Screw Discon+screw Screw Discon+screw Screw

# XM200/400

## MULTIPLEXED CABINET CONTROLLERS for NORMAL and LOW TEMPERATURE



L: 38x185mm

K: OS/GS

**XM244L**

Multifunction controller for multiplexed N.T. and L.T. ventilated applications with 4 defrost management

**XM440K**

Multifunction controller for multiplexed N.T. and L.T. applications with electrical or hot gas defrost function

FEATURES	XM244L	XM440K
<b>Display: n° digits</b>	± 3 d.p.	on keyboard ± 3 d.p.
<b>Keyboard: push buttons</b>	5	CX640 – T640 – V640: 6
<b>Power supply</b>	110, 230Vac	110, 230Vac
<b>Probe inputs</b>		
Thermostat	NTC	NTC
Defrost	NTC	NTC
Defrost 2	NTC	
Defrost 3	NTC	
Defrost 4	NTC	
Display		NTC
AUX		
Suction pressure		
Suction temperature		
<b>Digital inputs</b>		
Start defrost, pressure switch, AUX, generic alarm, serious alarm mode, light, ON/OFF, holiday		config
Energy saving		pres
<b>Relay outputs</b>		
Compressor	8A	8A
Defrost	8A	20A
Defrost 2	8A	
Defrost 3	8A	
Defrost 4	8A	
Fans	8A	
Light		16A
Alarm		
AUX		
<b>Other</b>		
Hot Key/Prog Tool Kit output	pres	pres
Remote display output		X-REP
Serial output	TTL	TTL, RS485 opt
4÷20mA/0÷10V output		
12V/30mA/PWM output		
Buzzer	opt	on keyboard opt
Real time clock	opt	opt
Valve driver output up to 30W		

XM244L

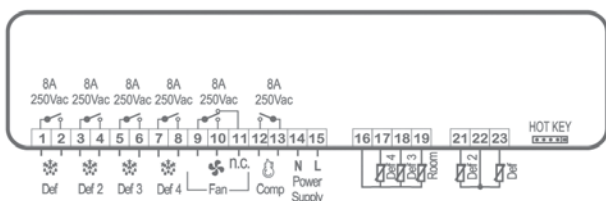

XM440K

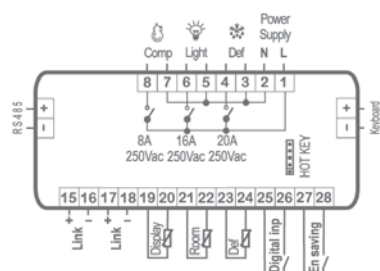

# XM400

## MULTIPLEXED CABINET CONTROLLERS for NORMAL and LOW TEMPERATURE



K: OS/GS

<b>XM460K</b>	Multifunction controller for N.T. and L.T. ventilated applications with 20A defrost relay and light relay
<b>XM463K</b>	Multifunction controller for N.T. and L.T. ventilated applications with defrost relay and light relay
<b>XM470K</b>	Multifunction controller for N.T. and L.T. ventilated applications with auxiliary output

FEATURES	XM460K	XM463K	XM470K
<b>Display: n° digits</b>	on keyboard ± 3 d.p.	on keyboard ± 3 d.p.	on keyboard ± 3 d.p.
<b>Keyboard: push buttons</b>	CX640 – T640 – V640: 6	CX640 – T640 – V640: 6	T840 – V840: 8
<b>Power supply</b>	110, 230Vac	110, 230Vac	110, 230Vac
<b>Probe inputs</b>			
Thermostat	NTC	NTC	NTC
Defrost	NTC	NTC	NTC
Defrost 2			
Defrost 3			
Defrost 4			
Display	NTC	NTC	NTC
AUX			
Suction pressure			
Suction temperature			
<b>Digital inputs</b>			
Start defrost, pressure switch, AUX, generic alarm, serious alarm mode, light, ON/OFF, holiday	config	config	config
Energy saving	pres	pres	pres
<b>Relay outputs</b>			
Compressor	8A	8A	8A
Defrost	20A	16A	20A
Defrost 2			
Defrost 3			
Defrost 4			
Fans	8A	8A	8A
Light	16A	16A	16A
Alarm			
AUX			8A
<b>Other</b>			
Hot Key/Prog Tool Kit output	pres	pres	pres
Remote display output	X-REP	X-REP	X-REP
Serial output	TTL, RS485 opt	TTL, RS485 opt	TTL, RS485 opt
4÷20mA/0÷10V output			
12V/30mA/PWM output			
Buzzer			
Real time clock			
Valve driver output up to 30W	on keyboard opt opt	on keyboard opt opt	on keyboard opt opt

XM460K

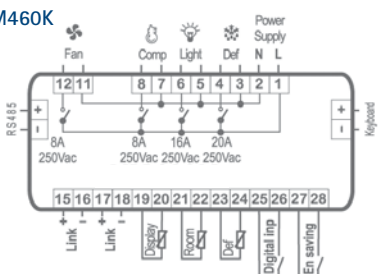

XM463K

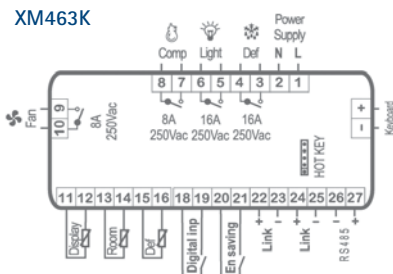

XM470K

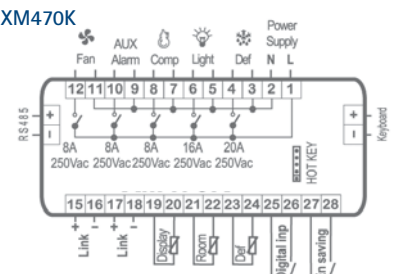

# XM600

## ADVANCED CONTROLLERS for NORMAL and LOW TEMPERATURE with EEV MANAGEMENT



K: OS/8 DIN Rail

<b>XM660K</b>	Advanced multifunction controller for N.T. and L.T. ventilated applications
<b>XM669K</b>	Advanced multifunction controller for N.T. and L.T. ventilated applications with ON/OFF electronic valve management

FEATURES	XM660K	XM669K
<b>Display: n° digits</b>	on keyboard ± 3 d.p.	on keyboard ± 3 d.p.
<b>Keyboard: push buttons</b>	CX660: 6	CX660: 6
<b>Power supply</b>	12Vac/dc - 24, 110, 230Vac - 110÷230Vac	12Vac/dc - 24, 110, 230Vac - 110÷230Vac
<b>Probe inputs</b>		
Thermostat	NTC/PTC/Pt1000 config	NTC/PTC/Pt1000 config
Defrost	NTC/PTC/Pt1000 config	NTC/PTC/Pt1000 config
Defrost 2		
Defrost 3		
Defrost 4		
Display	NTC/PTC/Pt1000 config	NTC/PTC/Pt1000 config
AUX	NTC/PTC/Pt1000 config	NTC/PTC/Pt1000 config
Suction pressure		NTC/PTC/Pt1000/4÷20mA/0÷5V config
Suction temperature		NTC/PTC/Pt1000 config
<b>Digital inputs</b>		
Start defrost, pressure switch, AUX, generic alarm, serious alarm mode, light, ON/OFF, holiday	2 config	2 config
Energy saving		
<b>Relay outputs</b>		
Compressor	8A	8A
Defrost	16A	16A
Defrost 2		
Defrost 3		
Defrost 4		
Fans	8A	8A
Light	16A	16A
Alarm		
AUX		
<b>Other</b>		
Hot Key/Prog Tool Kit output	pres	pres
Remote display output	X-REP	X-REP
Serial output	RS485	RS485
4÷20mA/0÷10V output	opt	opt
12V/30mA/PWM output	opt	opt
Buzzer	on keyboard opt	on keyboard opt
Real time clock	pres	pres
Valve driver output up to 30W	pres	pres

XM660K

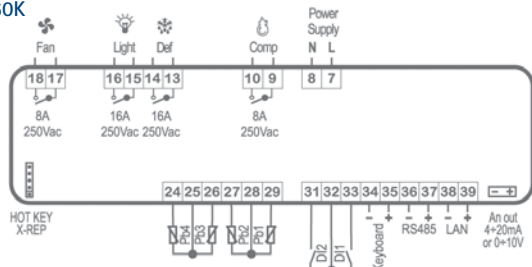

XM669K

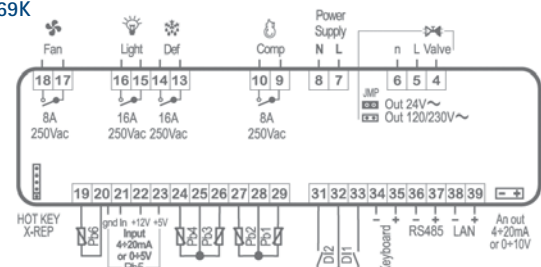

# XM600

## ADVANCED CONTROLLERS for NORMAL and LOW TEMPERATURE with EEV MANAGEMENT



K: 05/8 DIN Rail

**XM670K**

Advanced multifunction controller for N.T. and L.T. ventilated applications with auxiliary and alarm outputs

**XM679K**

Advanced multifunction controller for N.T. and L.T. ventilated applications with auxiliary and alarm outputs and ON/OFF electronic valve management

FEATURES	XM670K	XM679K
<b>Display: n° digits</b>	on keyboard ± 3 d.p.	on keyboard ± 3 d.p.
<b>Keyboard: push buttons</b>	CX660: 6	CX660: 6
<b>Power supply</b>	12Vac/dc - 24, 110, 230Vac - 110÷230Vac	12Vac/dc - 24, 110, 230Vac - 110÷230Vac
<b>Probe inputs</b>		
Thermostat	NTC/PTC/Pt1000 config	NTC/PTC/Pt1000 config
Defrost	NTC/PTC/Pt1000 config	NTC/PTC/Pt1000 config
Defrost 2		
Defrost 3		
Defrost 4		
Display	NTC/PTC/Pt1000 config	NTC/PTC/Pt1000 config
AUX	NTC/PTC/Pt1000 config	NTC/PTC/Pt1000 config
Suction pressure		NTC/PTC/Pt1000/4÷20mA/0÷5V config
Suction temperature		NTC/PTC/Pt1000 config
<b>Digital inputs</b>		
Start defrost, pressure switch, AUX, generic alarm, serious alarm mode, light, ON/OFF, holiday	3 config	3 config
Energy saving		
<b>Relay outputs</b>		
Compressor	5A	5A
Defrost	16A	16A
Defrost 2		
Defrost 3		
Defrost 4		
Fans	8A	8A
Light	16A	16A
Alarm	8A	8A
AUX	8A	8A
<b>Other</b>		
Hot Key/Prog Tool Kit output	pres	pres
Remote display output	X-REP	X-REP
Serial output	RS485	RS485
4÷20mA/0÷10V output	opt	opt
12V/30mA/PWM output	opt	opt
Buzzer	on keyboard opt	on keyboard opt
Real time clock	pres	pres
Valve driver output up to 30W		pres

**XM670K**

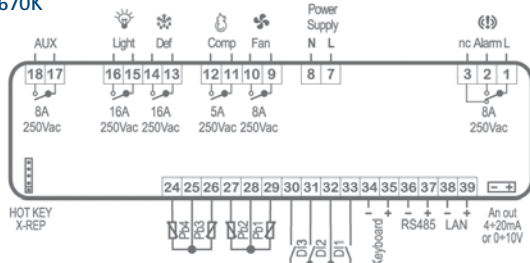

**XM679K**

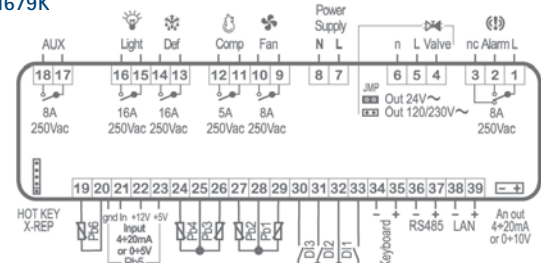

# XM400/600

## KEYBOARDS for MULTIPLEXED CABINET CONTROLLERS in K FORMAT



32x74mm      38x185mm      100x164mm

CX640 T640 V640	6 key keyboards for XM400 controllers
T840 V840	8 key keyboards for XM400 controllers
CX660	6 key keyboard for XM600 controllers

FEATURES	CX640 – T640 – V640	T840 – V840	CX660
Display: n° digits	± 3 d.p.	± 3 d.p.	± 3 d.p.
Keyboard: push buttons	6	8	6
Slave module	XM440K XM460K XM463K	XM470K	XM660K XM669K XM670K XM679K
Buzzer	opt	opt	opt



CX format is provided with a wide display with integrated icons of real time situation and of measurement unit, for clear and continuous monitoring

### THE POWER MODULES IN K FORMAT ARE AVAILABLE IN 3 DIFFERENT VERSIONS:

**OS:** open board for XM400 and XM600

**GS:** standard plastic case for XM400

**8 DIN Rail:** with 8 DIN plastic housing for XM600



### CONTROLLERS CAN BE COMBINED WITH:

**XM-RTC:** real time clock standard board

**XM-RTCB:** real time clock board with lithium battery

**XM-FC16:** female connectors kit 16 pins for XM660K and XM670K

**XM-FC21:** female connectors kit 21 pins for XM669K and XM679K





# ELECTRONIC EXPANSION VALVE DRIVERS

## SECTION INDEX

FUNCTIONS	MODELS	
<b>XEV - superheat regulation - serial output</b>		<b>96</b>
Drivers for on/off expansion valve management	XEV11D – XEV12D	98
Drivers for stepper electronic expansion valve management	XEV21D – XEV22D	98



D: 4 DIN Rail



## XEV SERIES: SUPERHEAT MANAGEMENT – SERIAL OUTPUT

- Drivers for ON/OFF (pulsed) and stepper electronic expansion valve management
- ON/OFF (pulsed) expansion valve support with 30W max power and coil c.a.
- Temperature analog inputs (NTC, PTC, PT1000)
- Pressure analog inputs (0÷5V, 4÷20mA)
- Possibility to broadcast via LAN the pressure signal to multiplexed cabinets
- Alarm management (visual, relay)
- Cool Defrost for defrost time reduction
- Standard communication protocol ModBUS-RTU
- Hot Key or Prog tool kit connector for a quick and easy programming
- 6VA max power absorption
- Display with red LED (10,5mm high) and icons

### HOW TO ORDER

XEV       -

**-17.8**

For blue display please contact Dixell

A	B	C	D	E
<b>Power supply</b>	<b>Temperature probe</b>	<b>Pressure probe</b>	<b>Measurement unit</b>	<b>Buzzer</b>
2 = 24Vac 4 = 120Vac 5 = 230Vac	P = Pt1000 N = NTC	0 = 0÷5V 1 = 4÷20mA 2 = PP11 3 = PP30 2 = PPR15 3 = PPR30	C = °C/bar F = °F/psi P = °C/psi	0 = No 1 = Yes



## FAST RECOVERY

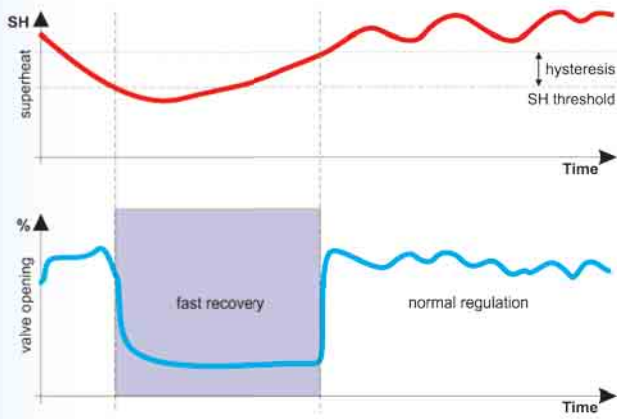

The XEV series uses a special algorithm to return to a normal situation of regulation after verifying a superheat alarm condition. Dixell's Fast Recovery algorithm corrects the superheat problems more rapidly than the traditional systems because if a critical situation occurs, the regulation system increases its speed of reaction.

## REFRIGERATION CIRCUIT

The diagram shows the different ways to connect the XEV drivers to a generic application like a single cooling unit or multiplexed cabinet. The valve is driven by the XEV module that is in turn commanded, by the activation of the digital input, from the temperature controller.

**SINGLE SYSTEM:** section 1 of the schematic diagram shows how connections would be arranged for a single cooling system.

**MULTIPLYED CABINET:** to reduce installation costs, it is possible to use a single suction pressure transducer as shown in the overall schematic diagram. This transducer's pressure signal is repeated to the other controllers across a digital LAN connection that guarantees optimal noise immunity.

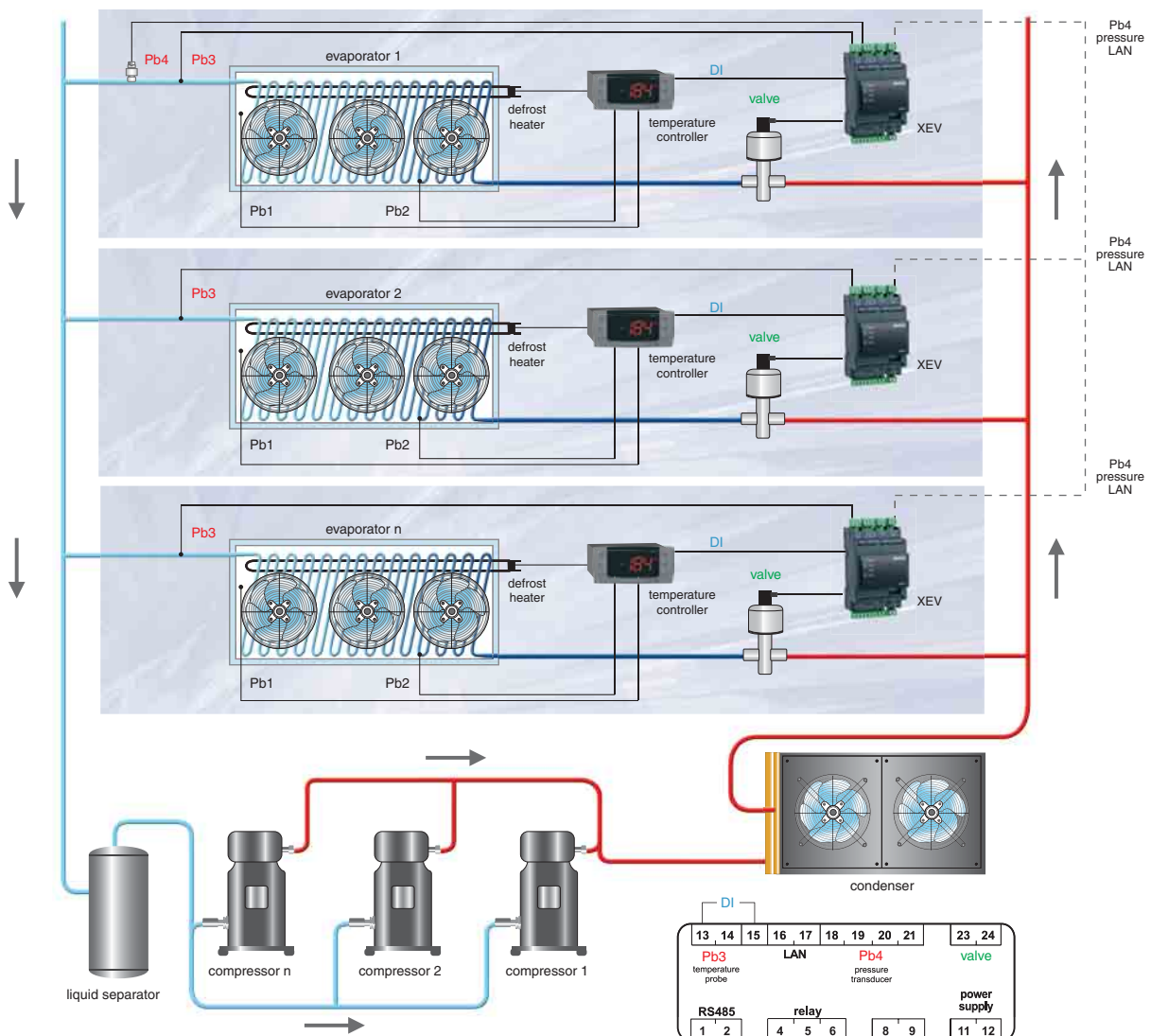

# XEV

## DRIVERS for ON/OFF and STEPPER ELECTRONIC EXPANSION VALVE MANAGEMENT



D: 4 DIN Rail

<b>XEV11D</b>	ON/OFF electronic expansion valve driver
<b>XEV12D</b>	ON/OFF electronic expansion valve driver with integrated display
<b>XEV21D</b>	Stepper electronic expansion valve driver
<b>XEV22D</b>	Stepper electronic expansion valve driver with integrated display

FEATURES	XEV11D	XEV12D	XEV21D	XEV22D
<b>Kind of valves</b>	ON/OFF	ON/OFF	stepper	stepper
<b>Display: n° digits</b>		± 3 d.p.		± 3 d.p.
<b>Keyboard: push buttons</b>		3		3
<b>Power supply</b>	24, 110, 230Vac	24, 110, 230Vac	24, 110, 230Vac	24, 110, 230Vac
<b>Probe inputs</b>				
Suction pressure	4÷20mA/0÷5V config	4÷20mA/0÷5V config	4÷20mA/0÷5V config	4÷20mA/0÷5V config
Suction temperature	Pt1000/NTC config	Pt1000/NTC config	Pt1000/NTC config	Pt1000/NTC config
<b>Digital inputs</b>				
Free of voltage	pres	pres	pres	pres
High voltage	pres	pres	pres	pres
<b>Relay output</b>				
Alarm	8A config	8A config	8A config	8A config
<b>Other</b>				
Valve driver output up to 30W	pres	pres		
Hot Key/Prog Tool Kit output	pres	pres	pres	pres
Remote keyboard output	KB1-PRG		KB1-PRG	
Serial output	RS485	RS485	RS485	RS485
Alarm recovery by LAN	pres	pres	pres	pres

XEV11D  
XEV21D

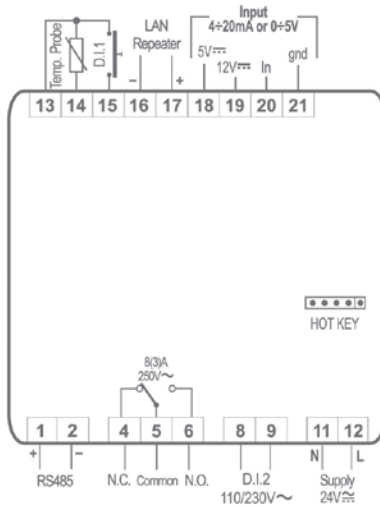

XEV12D  
XEV22D

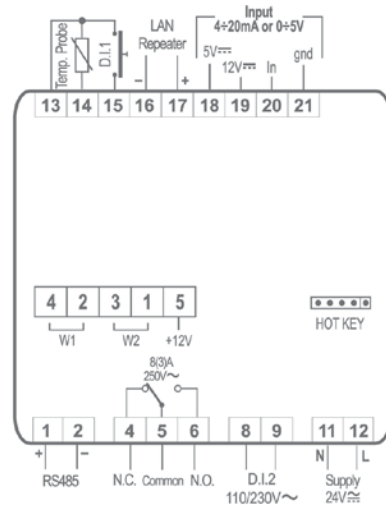

100x64mm

### KB1-PRG

6 key programming keyboard for XEV11D - XEV21D

**Display: n° digits:** ± 3 d.p.

**Keyboard: push buttons:** 6



For the connection between the keyboard and the XEV11D - XEV21D modules the **CAB/KB11** cable is available, 1m



## REFRIGERATED ROOM & TEMP./HUMIDITY CONTROLLERS

### SECTION INDEX

FUNCTIONS	MODELS	
<b>XLR100 COOL MATE - NT, MT and LT applications – serial output</b>		<b>100</b>
Advanced multifunction controller for N.T. refrigerated rooms	XLR130	101
Advanced multifunction controller for M.T. – L.T. refrigerated rooms	XLR170	101
<b>XLR400 COOL MATE - NT and LT applications – dual temperature management – serial output</b>		<b>102</b>
Advanced multifunction controller with dual temperature management for N.T. and L.T. refrigerated rooms	XLR460	103
Advanced multifunction controller with dual temperature management for L.T. refrigerated rooms	XLR470	103
<b>XLH200/300 COOL MATE - NT, LT and maturing room applications – temperature and humidity management - serial output</b>		<b>104</b>
Advanced multifunction controller for N.T. – L.T. refrigerated rooms with temperature and humidity management	XLH260	105
Advanced multifunction controller for N.T. maturing rooms with temperature and humidity management	XLH360	105
<b>XW200/500 + V-KIT - MT and LT applications – split format – serial output</b>		<b>106</b>
Advanced multifunction controllers with vertical format keyboard and wall mounting box for M.T. – L.T. refrigerated rooms	XW200/500 + V-KIT	106



230x210mm

**COOL MATE**

WALL  
MOUNTING

PANEL  
MOUNTING

## XLR100 COOL MATE SERIES: CONTROLLERS FOR NT, MT AND LT APPLICATIONS – SERIAL OUTPUT

- Advanced multifunction refrigeration controllers suitable for both heating and cooling applications
- Temperature control can be performed on probe 1, probe 2 or by the difference between probe 1 and 2
- Complete compressor and defrost management
- Maximum and minimum temperature recording
- Direct line power supply 230 (110)Vac. No external transformer required
- Instant visibility of machine status via display icons
- Clear alarm signals thanks to the front lid
- Fast and easy wiring
- Designed to be wall or panel mounted
- Standard communication protocol ModBUS-RTU
- Hot key or Prog tool kit connector for a quick and easy programming
- 10VA max power absorption
- Display with red LED (30,5mm high) and 11 icons

### HOW TO ORDER

XLR100 X L R 1   - A B C D E

**-17.8**

For blue display please contact Dixell

A	B	C	D	E
<b>Power supply</b>	<b>Input / kind of output</b>	<b>RTC</b>	<b>Measurement unit</b>	<b>Built-in RS485</b>
2 = 24Vac 4 = 110Vac 5 = 230Vac 8 = 110÷230Vac	N = NTC / standard P = PTC / standard O = NTC / direct loads Q = PTC / direct loads	1 = No 3 = Yes	C = °C F = °F	2 = No 3 = Yes

# XLR100

## ADVANCED MULTIFUNCTION CONTROLLERS for NORMAL, MEDIUM and LOW TEMPERATURE COLD ROOMS



230x210mm

**XLR130**

"off cycle" defrost digital controller for N.T.

**XLR170**

Digital controller for M.T. and L.T. ventilated applications

FEATURES	XLR130	XLR170
<b>Display: n° digits</b>	± 3 d.p.	± 3 d.p.
<b>Keyboard: push buttons</b>	8	8
<b>Power supply</b>	24, 110, 230Vac 110÷230Vac	24, 110, 230Vac 110÷230Vac
<b>Probe inputs</b>		
Thermostat	NTC/PTC	NTC/PTC
Defrost		NTC/PTC
Display	NTC/PTC	NTC/PTC
<b>Digital inputs</b>		
Alarm, block alarm, pressure switch, start defrost, energy saving, ON/OFF, AUX, holiday	config	config
Door switch	pres	pres
<b>Relay outputs</b>		
Compressor	20A	20A
Defrost		16A
Fans		8A
Light	16A	16A
AUX	20A	20A
Alarm	8A	8A
<b>Other</b>		
Hot Key/Prog Tool Kit output	pres	pres
Serial output	RS485 opt	RS485 opt
Buzzer	pres	pres
Real time clock	opt	opt

**XLR130**

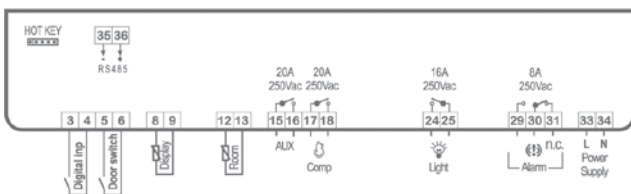

**direct load**

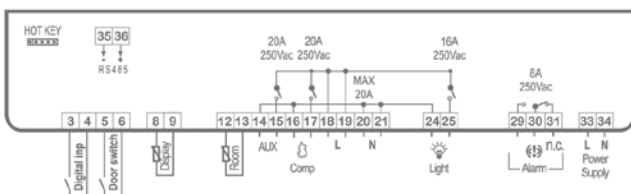

**XLR170**

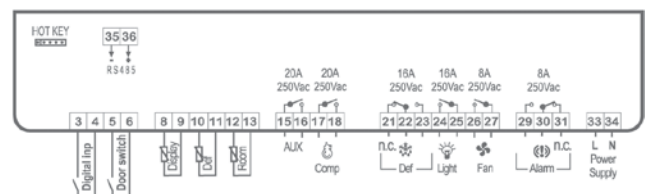

**direct load**

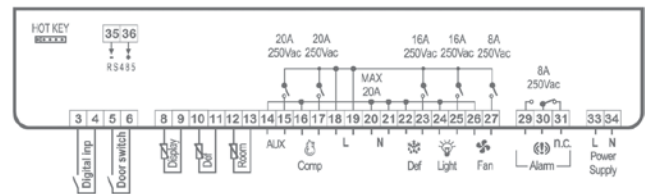



230x210mm

## COOL MATE

WALL MOUNTING

PANEL MOUNTING

# XLR400 COOL MATE SERIES: CONTROLLERS FOR NT AND LT APPLICATIONS DUAL TEMP. MANAGEMENT – SERIAL OUTPUT

- Advanced multifunction refrigeration controllers with dual temperature management
- Ideal for heating-cooling applications such as a heated bain-marie counter with refrigerated under-counter storage
- Designed for a dual refrigeration circuit or 2 independent circuits
- Integrated defrost management
- Cooling or heating action selectable by user
- Direct line power supply 230 (110)Vac. No external transformer required
- Instant visibility of machine status via display icons
- Clear alarm signals thanks to the front lid
- Designed to be wall or panel mounted
- Standard communication protocol ModBUS-RTU
- Hot key or Prog tool kit connector for a quick and easy programming
- 10VA max power absorption
- Dual display with red LED (25,3mm high) and yellow LED (20,3mm high) and 13 icons

### TYPICAL APPLICATIONS

#### 1 circuit – 2 evaporators

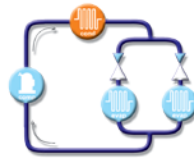

#### Heating and cooling application

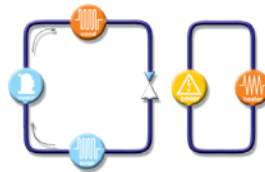

#### 2 independent circuits

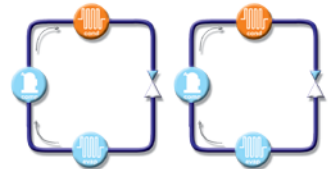

#### 2 heating applications

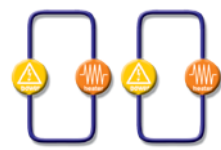

### HOW TO ORDER

XLR400 [X] [L] [R] [4] [ ] [ ] - [A] [0] [C] [D] [E]

A	C	D	E
<b>Power supply</b> 2 = 24Vac 4 = 110Vac 5 = 230Vac 8 = 110÷230Vac	<b>RTC</b> 0 = No 1 = Yes	<b>Measurement unit</b> C = °C F = °F	<b>Built-in RS485</b> 0 = No 1 = Yes

# XLR400

## ADVANCED MULTIFUNCTION CONTROLLERS with DUAL TEMP. MANAGEMENT for NORMAL and LOW TEMP. COLD ROOMS



230x210mm

<b>XLR460</b>	Digital controller for cold rooms with dual temperature management (N.T. + L.T.)
<b>XLR470</b>	Digital controller for cold rooms with dual temperature management (L.T. + L.T.)

FEATURES	XLR460	XLR470
<b>First display: n° digits</b>	± 3 d.p.	± 3 d.p.
<b>Second display: n° digits</b>	± 4 d.p.	± 4 d.p.
<b>Keyboard: push buttons</b>	8	8
<b>Power supply</b>	24, 110, 230Vac 110÷230Vac	24, 110, 230Vac 110÷230Vac
<b>Probe inputs</b>		
Thermostat	NTC	NTC
Thermostat 2	NTC	NTC
Defrost	NTC	NTC
Defrost 2	NTC	NTC
<b>Digital inputs</b>		
Alarm, block alarm, pressure switch, start defrost, energy saving, ON/OFF, AUX, holiday	config	config
Door switch	pres	pres
<b>Relay outputs</b>		
Compressor	20A	20A
Compressor 2	20A	20A
Defrost	16A	16A
Defrost 2	16A	5A
Fans	8A	5A
Fans 2	8A	5A
Light	16A	16A
Alarm	8A	8A
<b>Other</b>		
Hot Key/Prog Tool Kit output	pres	pres
Serial output	RS485 opt	RS485 opt
Buzzer	pres	pres
Real time clock	opt	opt

XLR460

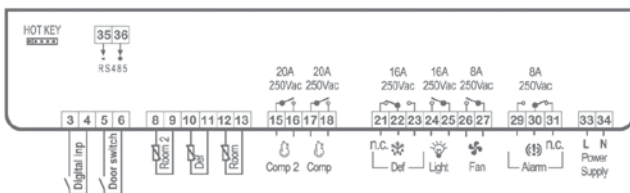

XLR470

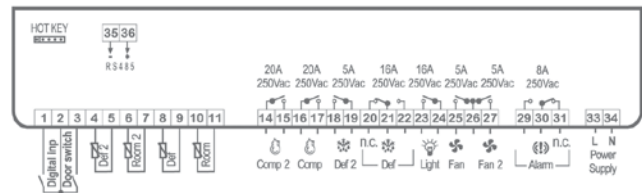



WALL MOUNTING

PANEL MOUNTING

230x210mm

**COOL MATE**

## XLH200/300 COOL MATE SERIES: CONTROLLERS FOR NT, LT AND MATURING APPLICATIONS – TEMP./HUMIDITY MANAGEMENT – SERIAL OUTPUT

- Advanced multifunction controllers with temperature and humidity management
- Cooling and heating action for safe storage of products
- Defrost management
- Possibility of excluding humidity control
- Dehumidifying action by cooling circuit
- Running and stopping programmable cycles with different set points (XLH300)
- Automatic cycles of extraction fans (XLH300)
- Direct line power supply 230 (110)Vac. No external transformer required
- Instant visibility of machine status via display icons
- Clear alarm signals thanks to the front lid
- Designed to be wall or panel mounted
- Standard communication protocol ModBUS-RTU
- Hot key or Prog tool kit connector for a quick and easy programming
- 10VA max power absorption
- Dual display with red LED (25,3mm high) and yellow LED (20,3mm high) and 17 icons

### HOW TO ORDER

XLH200/300 X L H    - A O O D E

A	D	E
<b>Power supply</b>	<b>Measurement unit</b>	<b>Built-in RS485</b>
2 = 24Vac 4 = 110Vac 5 = 230Vac 8 = 110÷230Vac	C = °C F = °F	0 = No 1 = Yes



# XLH200/300

## ADVANCED MULT. CONT. with TEMP./HUMIDITY MANAGEMENT for N. and L. TEMP. COLD ROOMS AND MATURING ROOMS



230x210mm

<b>XLH260</b>	Digital controller for N.T. and L.T. cold rooms with temperature and humidity management
<b>XLH360</b>	Digital controller for maturing rooms with temperature and humidity management

FEATURES	XLH260	XLH360
<b>First display: n° digits</b>	± 3 d.p.	± 3 d.p.
<b>Second display: n° digits</b>	± 4 d.p.	± 4 d.p.
<b>Keyboard: push buttons</b>	6	8
<b>Power supply</b>	24, 110, 230Vac 110÷230Vac	24, 110, 230Vac 110÷230Vac
<b>Probe inputs</b>		
Thermostat	NTC	NTC
Defrost	NTC	NTC
Humidity	4÷20mA	4÷20mA
<b>Digital inputs</b>		
Alarm, block alarm, pressure switch, start defrost, energy saving, ON/OFF, AUX, holiday	config	config
Door switch	pres	pres
<b>Relay outputs</b>		
Compressor	20A	20A
Defrost	16A	
Defrost, extractor fans		16A config
Fans	8A	8A
Heater control	20A	20A
Humidifying	8A	8A
Dehumidifying, light	16A config	16A config
Alarm		
Extractor fans		
<b>Other</b>		
Hot Key/Prog Tool Kit output	pres	pres
Serial output	RS485 opt	RS485 opt
Buzzer	pres	pres

XLH260

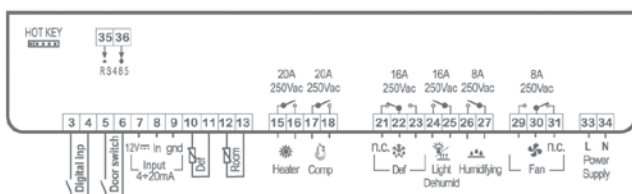

XLH360

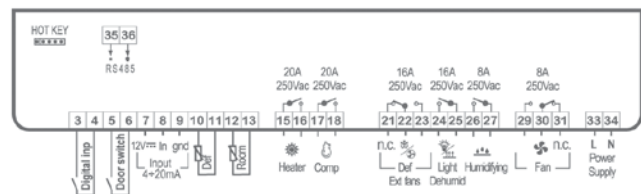



100x64mm

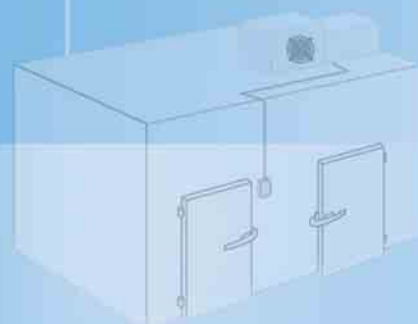

## XW200/500 + V-KIT SERIES: CONTROLLERS FOR MT, LT APPLICATIONS – SPLIT FORMAT – SERIAL OUTPUT

- **V-KIT:** a wall/panel mounting housing kit for vertical format keyboards (V600 and V800 series) for remote connection to XW200K and XW500K Series refrigeration controllers
- Designed for cold rooms applications
- LT and MT models available
- Connections: 2 wire electric cable up to 100 m
- IP55 against water sprinkles
- Easy and quick to install
- 100m maximum distance is possible
- Direct line power supply 230 (110)Vac from the controller. No external transformer required
- Standard communication protocol ModBUS-RTU
- Hot key or Prog tool kit connector for a quick and easy programming
- 10VA max power absorption
- Display with red LED (13,2mm high)

### COLD ROOM APPLICATION

The Dixell V-KIT allows the user to mount the keyboard near to the cold-room door. Connection between the power board (eg. XW270K) and the keyboard is via a 2 core cable. The maximum distance possible is 100m. The door-switch facility is activated when the door is open, the light is automatically switched on, while the compressor, up to 1.5HP, and the evaporator fan can be simultaneously stopped.

The innovative design of this housing gives a quick and effective solution for a variety of different applications, such as cold-rooms, benches and industrial environments where it is difficult to mount the keyboard on a wall. It's available in 3 different colours making it suitable for all applications, even where appearance plays part. A main feature is ease of assembly and with IP55 protection, it can be used in environments that may be subject to water spray or rigorous cleaning routines.

**The V-KIT is suitable for all vertical format keyboards.**

For more information about keyboards and WING modules that can be used with V-KIT, please check the information regarding XW200/500 Series.



## BLAST CHILLER/FREEZER REFRIGERATION CONTROLLERS

### SECTION INDEX

FUNCTIONS	MODELS	
<b>XB - blast chiller and temperature maintenance applications – serial output</b>		<b>108</b>
Blast chiller digital controller	XB570L	110



L: 38x185mm

## XB SERIE: CONTROLLERS FOR BLAST CHILLER AND TEMPERATURE MAINTENANCE APPLICATIONS – SERIAL OUTPUT

- Design to comply with the rules concerning preparation and chilling of foodstuffs (HACCP)
- Four configurable cycles: pre-set according to the most common food – safety applications: soft chill, hard chill and freezing
- Output for remote display to monitor the core temperature of goods
- Internal real time clock
- Printer output (XB07PR) for temperature and blast chiller cycles reports
- All different phases monitorated and shown on the display
- Ultra violet sterilization cycle management
- Standard communication protocol ModBUS-RTU
- Hot Key 128 or Prog tool kit connector for a quick and easy programming
- 5VA max power absorption
- Dual display with red LED (8,0mm high) and yellow LED (5,6mm high) and 14 icons

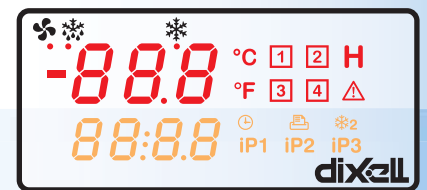

### HOW TO ORDER

XB [X] [B] [5] [7] [0] [L] [-] [A] [B] [C] [D] [E]



For blue display please contact Dixell

A	B	C	D	E
<b>Power supply</b>	<b>Input</b>	<b>X-REP output</b>	<b>Measurement unit</b>	<b>Printer output</b>
2 = 24Vac 4 = 110Vac 5 = 230Vac	N = NTC P = PTC	0 = No 1 = Yes	C = °C F = °F	0 = No 1 = Yes

## HACCP: A POSITIVE SOLUTIONS

The XB570L controller is dedicated to blast chiller applications and gives a solution to HACCP system.

With the XB570L, food is rapidly cooled (both at +3°C and at -18°C) immediately after it has been cooked, to avoid the proliferation of bacteria that occurs when food is allowed to cool naturally or in a normal refrigerator.

Ease of use and complete management of each blast chilling phase is guaranteed by 4 cycles that can be adjusted to suit any type of food. It is possible to display the temperature of either the air or the food insertion probe.

The hygiene of the blast chiller is guaranteed by an extra configurable output for sterilization by means of ultraviolet rays.

The optional XB07PR printer can be connected to the XB570L controllers to provide the user with a written report of all the main data required: cycle start and stop times, duration, the temperature of the product or the coldroom, all at regular intervals, via an internal time clock.

```

* START CYCLE 3
DATE : 13/04/2008
PROBES REPORT 15:19
Insr. Probe : - 1.4°C
Room Probe : -22.6°C
PROBES REPORT 15:20
Insr. Probe : - 2.4°C
Room Probe : -22.6°C
START PHASE 1 15:20
Room SET : -30.0°C
I.Prb SET : -18.0°C
TIME : 240 min
PROBES REPORT 15:25
Insr. Probe : - 2.6°C
Room Probe : -22.6°C
PROBES REPORT 15:30
Insr. Probe : - 2.6°C
Room Probe : -23.6°C
PROBES REPORT 15:35
Insr. Probe : - 3.4°C
Room Probe : -25.6°C
PROBES REPORT 15:40
Insr. Probe : - 4.2°C
Room Probe : -26.6°C
PROBES REPORT 15:45
Insr. Probe : - 5.0°C
Room Probe : -30.6°C
PROBES REPORT 15:50
Insr. Probe : - 6.5°C
Room Probe : -30.6°C
PROBES REPORT 15:55
Insr. Probe : - 8.0°C
Room Probe : -30.6°C
PROBES REPORT 16:00
Insr. Probe : - 9.5°C
Room Probe : -30.6°C
PROBES REPORT 16:05
Insr. Probe : -12.6°C
Room Probe : -30.6°C
PROBES REPORT 16:10
Insr. Probe : -18.0°C
Room Probe : -30.6°C
END PHASE 1 16:10
Duration : 49 min
* END CYCLE 3 16:10
Duration : 51 min

START HOLDING 16:10
Room SET : -18.0°C
    
```

## FREEZING CYCLE: HOW IT IS ACHIEVED

The XB570L has 4 different soft and hard chill cycles in it's memory. These can also be modified by the User.

Each cycle is defined with independent time and temperature parameters to set each control phase and can be combined even with the hold phase. The four cycles are directly selectable from the keyboard. The control of each cycle is carried out using the insert probe or by time duration.

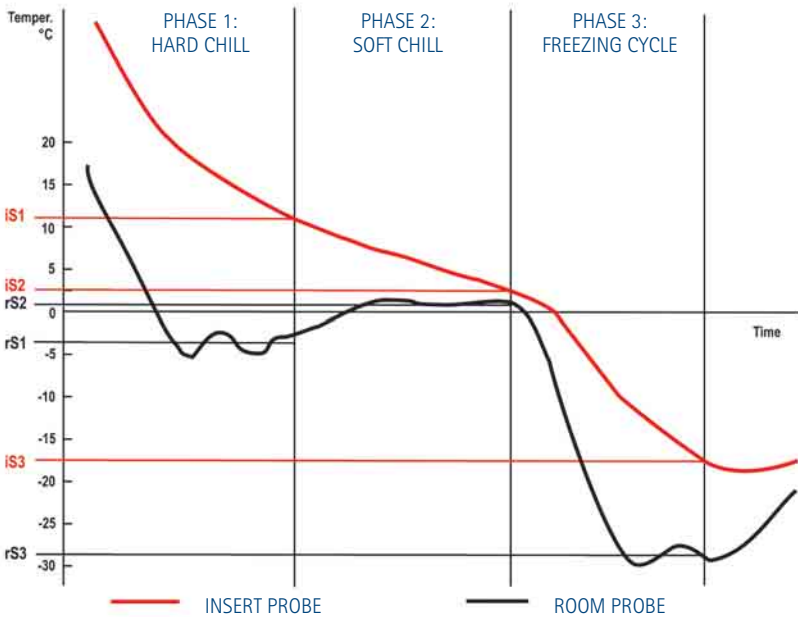

The drawing shows a typical freezing cycle

Each cycle (Cy1, Cy2, Cy3 and Cy4) can be programmed with three different phases according to the food type.

- **First phase: hard chill**

Limits bacteria reproduction during the initial phase (from high temperature down to 2 °C). During "Hard Chill", both compressor and fan are always "on" until the end cycle temperature is reached.

- **Soft chill phase**

Reduces the variation between the surface and core temperatures of the product. During "Soft Chill" the temperature of the room is regulated by the ambient probe: compressor is cycled to maintain a particular air temperature.

- **Freezing cycle phase**

Freezes the product in the shortest possible time. During the "Freezing Cycle" both compressor and fan are always on until the end temperature is reached.

- **Holding phase**

The holding phase maintains the final temperature reached by the chilling cycle.

# XB

## BLAST CHILLER DIGITAL CONTROLLER



L: 38x185mm

**XB570L**

Blast chiller digital controller with four configurable cycles, RTC, printer output and serial output

FEATURES	XB570L
<b>First display: n° digits</b>	± 3 d.p.
<b>Second display: n° digits</b>	± 4 d.p.
<b>Keyboard: push buttons</b>	8
<b>Power supply</b>	24, 110, 230Vac
<b>Probe inputs</b>	
Thermostat	NTC/PTC
Defrost	NTC/PTC
Insert 1	NTC/PTC
Insert 2	NTC/PTC
Insert 3	NTC/PTC
<b>Digital inputs</b>	
Alarm	config
Door switch	pres
<b>Relay outputs</b>	
Compressor	20A
Defrost	8A
Fans	8A
Light	16A
AUX	8A
Alarm	16A
<b>Other</b>	
Hot Key 128/Prog Tool Kit output	pres
Remote display output	X-REP opt
Printer output	XB07PR opt
Serial output	RS485
Buzzer	pres
Real time clock	pres

### XB570L





## COMBINED TEMP./HUMIDITY REFRIGERATION CONTROLLERS

### SECTION INDEX

FUNCTIONS	MODELS	
<b>XH - MT and LT applications, maturing room and freezing / proving cabinet – serial output</b>		<b>112</b>
Controllers for M.T. – L.T. with temperature and humidity management	XH240L - XH240V - XH240K - XH260L - XH260V	114
Controllers for maturing rooms with temperature and humidity management	XH340L - XH340V- XH360L - XH360V	115
Controller for freezing and proving cabinets with temperature and humidity management	XH460L	116
Keyboards for controllers in K format	TH620 - VH620	116



## XH SERIES: CONTROLLERS FOR MT AND LT APPLICATIONS, MATURING ROOM AND FREEZING/PROVING CABINET – SERIAL OUTPUT

- Advanced multifunction controllers with temperature and humidity management
- Cooling and heating action for safe storage of products
- Defrost management
- Possibility of excluding humidity control
- Dehumidifying action by cooling circuit
- Running and stopping programmable cycles with different set points (XH300)
- Automatic cycles of extraction fans (XH300)
- Freezing and proving cycles fully configurable by user (XH400)
- Freezing phase without humidity control (XH400)
- Innovative and elegant design that enhances the aesthetics and functionality of the final product
- Up to 8 push buttons with direct action for user friendly interface
- Direct line power supply 230 (110)Vac. No external transformer required
- Standard communication protocol ModBUS-RTU
- Hot key or Prog tool kit connector for a quick and easy programming
- 10VA max power absorption
- Dual display with red LED (8,0mm high) and yellow LED (5,6mm high) and 14 icons

### HOW TO ORDER

XH       -

**inox** **-17.8** For Inox version and blue display please contact Dixell

XH240K       -

A	C	D
<b>Power supply</b>	<b>Buzzer</b>	<b>Measurement unit</b>
2 = 24Vac 4 = 110Vac 5 = 230Vac	0 = No 1 = Yes	C = °C - %RH F = °F - %RH

KEYBOARDS      -

**inox** **-17.8** For Inox version and blue display please contact Dixell

C	D
<b>Buzzer</b>	<b>Measurement unit</b>
0 = No 1 = Yes	C = °C - %RH F = °F - %RH



DISPLAY ICONS	MEANING
°C	Celsius degrees
°F	Fahrenheit degrees
❄️	Compressor
☀️	Heater control
(!)	Alarm
🌀	Fans
%RH	RH%
⬇️⬇️⬇️	Dehumidifying
⬆️⬆️⬆️	Humidifying
set	Temperature and humidity setting
📊	Running cycle (for XH300/400)
🕒	Cycle duration setting (for XH300)
💡	Light



## COMPLETE

The **dual display** and the **14 icons** show complete information about the status of the machine. Without the need to enter into the programming mode, all the main functioning of the cooling system are displayed with only one key touch.

## XH200: TEMPERATURE AND HUMIDITY CONTROL

A neutral zone algorithm is used both for temperature and humidity. Instruments are provided with a compressor output (with defrost) and heating elements to control temperature. Humidifier and dehumidifier (depending on model) outputs are provided for humidity. This assures both variables are kept inside the set band (neutral zone)

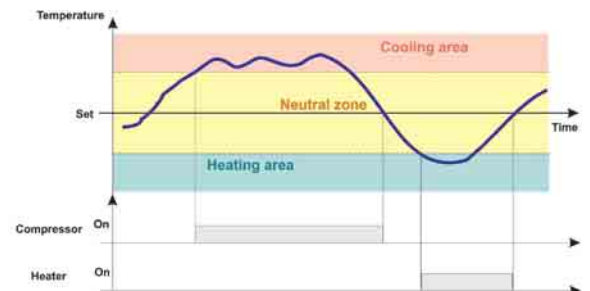

## XH300: EG. MATURING CYCLE WITH RUNNING AND STOPPING PHASE

T1: pre-cycle only with temperature control

T2: cycle with temperature and humidity control

T3: stopping phase

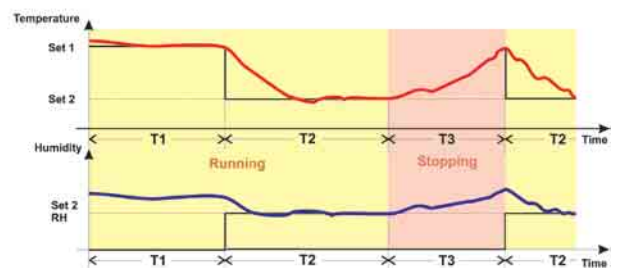

## XH400: EG. FREEZING/PROVING WITH HOLDING

T1: freezing phase only temperature control

T2: proving phase humidity and temperature control

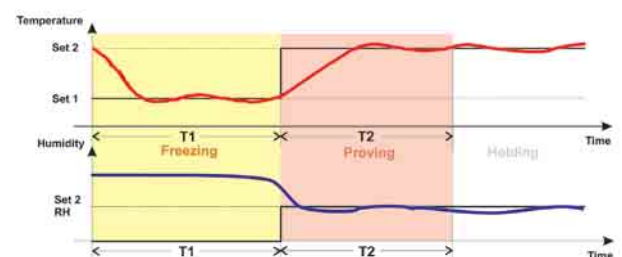

# XH200

## CONTROLLERS for MEDIUM and LOW TEMPERATURE with TEMPERATURE and HUMIDITY MANAGEMENT



L: 38x185mm V: 100x64mm K: 05/GS

**XH240L**  
**XH240V**  
**XH240K**

Multifunction digital controllers for M.T. and L.T. with temperature and humidity management

**XH260L**  
**XH260V**

Multifunction digital controllers for M.T. and L.T. with temperature and humidity management, defrost management and dehumidifying/light configurable relay

FEATURES	XH240L	XH240V	XH240K	XH260L	XH260V
<b>First display: n° digits</b>	± 3 d.p.	± 3 d.p.	on keyboard ± 3 d.p.	± 3 d.p.	± 3 d.p.
<b>Second display: n° digits</b>	± 4 d.p.	± 4 d.p.	on keyboard ± 4 d.p.	± 4 d.p.	± 4 d.p.
<b>Keyboard: push buttons</b>	6	6	TH620-VH620: 6	6	6
<b>Power supply</b>	24, 110, 230Vac	24, 110, 230Vac	24, 110, 230Vac	24, 110, 230Vac	24, 110, 230Vac
<b>Probe inputs</b>					
Thermostat	NTC	NTC	NTC	NTC	NTC
Defrost				NTC	NTC
Humidity	4÷20mA	4÷20mA	4÷20mA	4÷20mA	4÷20mA
<b>Digital inputs</b>					
Heater safety, door switch	config	config	config	config	config
<b>Relay outputs</b>					
Compressor	20A	8A	20A	20A	8A
Defrost				8A	8A
Defrost, extractor fans					
Fans	8A	8A	8A	8A	8A
Heater control	8A	8A	16A	8A	8A
Humidifying	8A	8A	8A	8A	8A
Dehumidifying, light				8A	8A
Light	8A	8A			
<b>Other</b>					
Hot Key/Prog Tool Kit output	pres	pres	pres	pres	pres
Serial output	TTL	TTL	TTL	TTL	TTL
Buzzer	opt	opt	on keyboard opt	opt	opt

XH240L

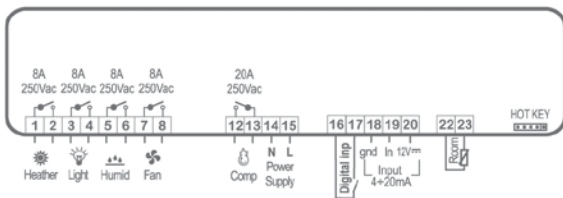

XH260L

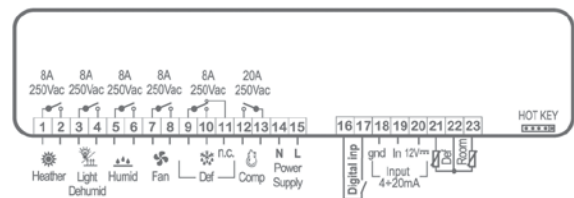

XH240V

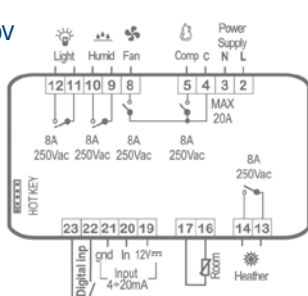

XH260V

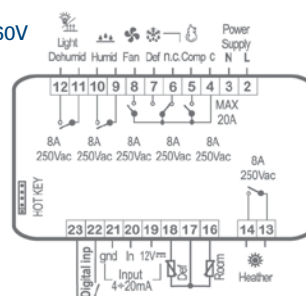

XH240K

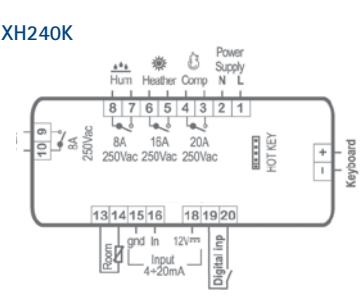

# XH300

## CONTROLLERS for MATURING ROOMS with TEMPERATURE and HUMIDITY MANAGEMENT



L: 38x185mm



V: 100x64mm

**XH340L**  
**XH340V**

Multifunction digital controllers for maturing rooms with management of: temperature and humidity, running and stopping cycles, cooling and heating action

**XH360L**  
**XH360V**

Multifunction digital controllers for maturing rooms with management of: temperature and humidity, running and stopping cycles, cooling and heating action, defrost

FEATURES	XH340L	XH340V	XH360L	XH360V
<b>First display: n° digits</b>	± 3 d.p.	± 3 d.p.	± 3 d.p.	± 3 d.p.
<b>Second display: n° digits</b>	± 4 d.p.	± 4 d.p.	± 4 d.p.	± 4 d.p.
<b>Keyboard: push buttons</b>	8	8	8	8
<b>Power supply</b>	24, 110, 230Vac	24, 110, 230Vac	24, 110, 230Vac	24, 110, 230Vac
<b>Probe inputs</b>				
Thermostat	NTC	NTC	NTC	NTC
Defrost			NTC	NTC
Humidity	4÷20mA	4÷20mA	4÷20mA	4÷20mA
<b>Digital inputs</b>				
Heater safety, door switch	config	config	config	config
<b>Relay outputs</b>				
Compressor	20A	8A	20A	8A
Defrost				
Defrost, extractor fans			8A	8A
Fans	8A	8A	8A	8A
Heater control	8A	8A	8A	8A
Humidifying			8A	8A
Dehumidifying, light	8A	8A	8A	8A
Light	8A	8A		
<b>Other</b>				
Hot Key/Prog Tool Kit output	pres	pres	pres	pres
Serial output	TTL	TTL	TTL	TTL
Buzzer	opt	opt	opt	opt

**XH340L**

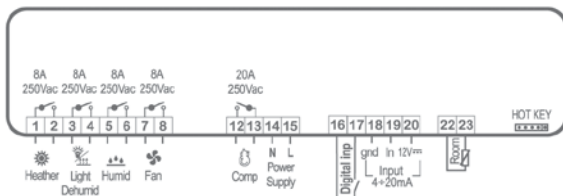

**XH360L**

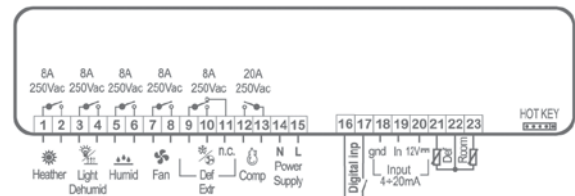

**XH340V**

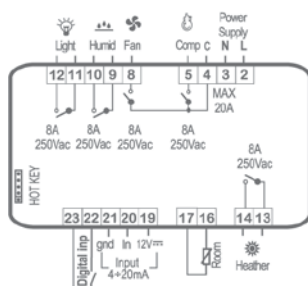

**XH360V**

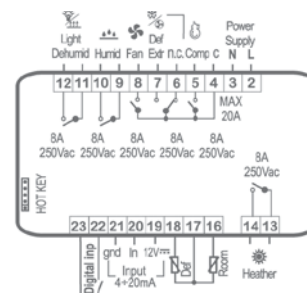

# XH400

## CONTROLLER for FREEZING and PROVING CABINETS with TEMPERATURE and HUMIDITY MANAGEMENT



L: 38x185mm

XH460L

Multifunction digital controller for freezing and proving cabinets with freezing phase without humidity control

FEATURES	XH460L
First display: n° digits	± 3 d.p.
Second display: n° digits	± 4 d.p.
Keyboard: push buttons	8
Power supply	24, 110, 230Vac
<b>Probe inputs</b>	
Thermostat	NTC
Defrost	NTC
Humidity	4÷20mA
<b>Digital inputs</b>	
Heater safety, door switch	config
<b>Relay outputs</b>	
Compressor	20A
Defrost	8A
Defrost, extractor fans	
Fans	8A
Heater control	8A
Humidifying	8A
Dehumidifying, light	8A
Light	
<b>Other</b>	
Hot Key/Prog Tool Kit output	pres
Serial output	TTL
Buzzer	opt

XH460L

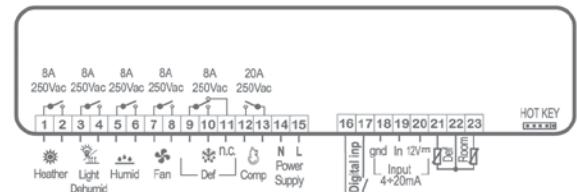

# XH

## KEYBOARDS for MULTIFUNCTION CONTROLLER in K FORMAT



38x185mm



100x164mm

TH620  
VH620

6 key keyboards for XH200 controller in K format

FEATURES	TH620	VH620
First display: n° digits	± 3 d.p.	± 3 d.p.
Second display: n° digits	± 4 d.p.	± 4 d.p.
Keyboard: push buttons	6	6
Slave module	XH240K	XH240K
Buzzer	opt	opt

### THE POWER MODULE IN K FORMAT IS AVAILABLE IN 2 DIFFERENT VERSIONS:

OS: open board



GS: with plastic housing 190x140x70mm





## DUAL TEMPERATURE REFRIGERATION CONTROLLERS

### SECTION INDEX

FUNCTIONS	MODELS	
<b>XR400-XW400</b> - NT, MT and LT applications - serial output		<b>118</b>
Advanced multifunction controllers for N.T. and with dual temperature management	XR420C - XW420L - XW420V	119
Advanced multifunction controllers for M.T. - L.T. and with dual temperature management	XR460C - XW460L - XW460V	120



V: 100x64mm



C: 32x74mm



L: 38x185mm

## XR400-XW400 SERIES: CONTROLLERS FOR NT, MT AND LT APPLICATIONS – SERIAL OUTPUT

- Advanced multifunction refrigeration controllers with dual temperature management
- Ideal for heating-cooling applications such as bain-marie with under-counter refrigerated storage
- Designed for a dual refrigeration circuit or 2 independent circuits
- Integrated defrost management
- Cooling or heating action settable by user
- Instant visibility of machine status via display icons
- Standard communication protocol ModBUS-RTU
- Hot key or Prog tool kit connector for a quick and easy programming
- 4VA max power absorption
- Dual display with red LED (8,0mm high) and yellow LED (5,6mm high) and 14 icons

More information about typical applications at page 102

### HOW TO ORDER

XR400       -

For blue display please contact Dixell

A	B	C	D
<b>Power supply</b> 0 = 12Vac/dc 1 = 24Vac/dc 2 = 24Vac 4 = 110Vac 5 = 230Vac	<b>Buzzer</b> 0 = No 1 = Yes	<b>RTC</b> 0 = No 1 = Yes	<b>Measurement unit</b> C = °C F = °F

XW400       -

For Inox version and blue display please contact Dixell

A	B	C	D
<b>Power supply</b> 2 = 24Vac 4 = 110Vac 5 = 230Vac	<b>Buzzer</b> 0 = No 1 = Yes	<b>RTC</b> 0 = No 1 = Yes	<b>Measurement unit</b> C = °C F = °F

# XR400-XW400

## ADVANCED MULTIFUNCTION CONTROLLERS with DUAL TEMPERATURE MANAGEMENT for NORMAL TEMPERATURE



C: 32x74mm

L: 38x185mm

V: 100x64mm

XR420C  
XW420L  
XW420V

Advanced multifunction controllers for N.T. with "off cycle" defrost and light relay

FEATURES	XR420C	XW420L	XW420V
<b>First display: n° digits</b>	± 3 d.p.	± 3 d.p.	± 3 d.p.
<b>Second display: n° digits</b>	± 4 d.p.	± 4 d.p.	± 4 d.p.
<b>Keyboard: push buttons</b>	4	8	8
<b>Power supply</b>	24, 110, 230Vac	24, 110, 230Vac	24, 110, 230Vac
<b>Probe inputs</b>			
Thermostat	NTC/PTC	NTC/PTC	NTC/PTC
Thermostat 2	NTC/PTC	NTC/PTC	NTC/PTC
Defrost			
<b>Digital inputs</b>			
Safety, start defrost, door switch	config	config	config
Safety, start defrost, door switch			
<b>Relay outputs</b>			
Compressor	8A	20A	8A
Compressor 2	8A	8A	8A
Defrost			
Fans			
Light	8A	8A	8A
Light 2			
<b>Other</b>			
Hot Key/Prog Tool Kit output	pres	pres	pres
Serial output	TTL	TTL	TTL
Buzzer	opt	opt	opt
Real time clock	opt	opt	opt

XR420C

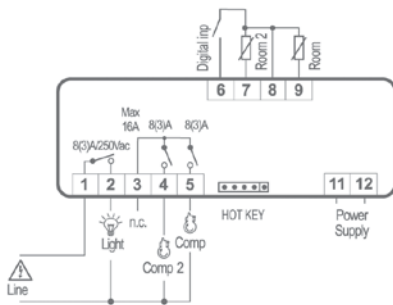

XW420V

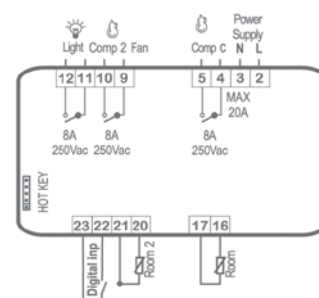

XW420L

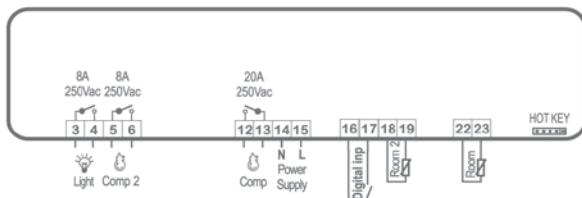

# XR400-XW400

## ADVANCED MULTIFUNCTION CONTROLLERS with DUAL TEMP. MANAGEMENT for MEDIUM and LOW TEMP.



C: 32x74mm

L: 38x185mm

V: 100x64mm

XR460C  
XW460L  
XW460V

Advanced multifunction controllers for M.T. and L.T. ventilated applications with defrost relay

FEATURES	XR460C	XW460L	XW460V
<b>First display: n° digits</b>	± 3 d.p.	± 3 d.p.	± 3 d.p.
<b>Second display: n° digits</b>	± 4 d.p.	± 4 d.p.	± 4 d.p.
<b>Keyboard: push buttons</b>	4	8	8
<b>Power supply</b>	12, 24Vac/dc	24, 110, 230Vac	24, 110, 230Vac
<b>Probe inputs</b>			
Thermostat	NTC/PTC	NTC/PTC	NTC/PTC
Thermostat 2	NTC/PTC	NTC/PTC	NTC/PTC
Defrost	NTC/PTC	NTC/PTC	NTC/PTC
<b>Digital inputs</b>			
Safety, start defrost, door switch	config	config	config
Safety, start defrost, door switch	config		
<b>Relay outputs</b>			
Compressor	8A	20A	8A
Compressor 2	8A	8A	8A
Defrost	8A	8A	8A
Fans	8A	8A	8A
Light		8A	8A
Light 2		8A	8A
<b>Other</b>			
Hot Key/Prog Tool Kit output	pres	pres	pres
Serial output	TTL	TTL	TTL
Buzzer	opt	opt	opt
Real time clock	opt	opt	opt

XR460C

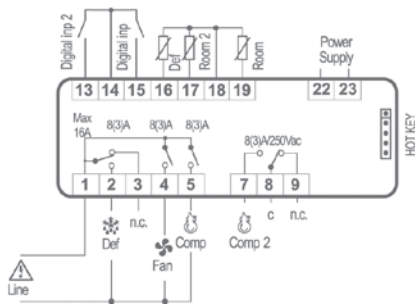

XW460V

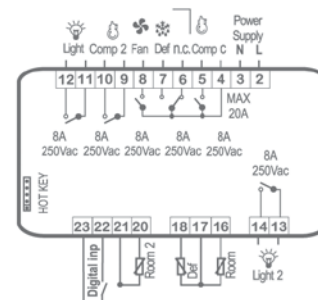

XW460L

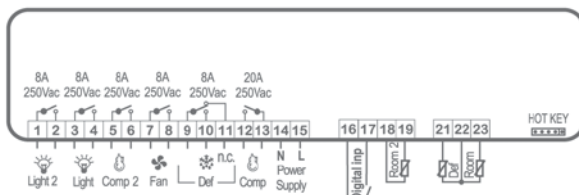





# COMPRESSOR RACK REFRIGERATION CONTROLLERS

## SECTION INDEX

FUNCTIONS	MODELS	
<b>XC400/600 - up to 6 screw compressor/fan output applications – serial output</b>		<b>122</b>
Controller for managing up to 2 compressors or fans	XC420C	124
Controllers for managing up to 4 compressors or fans	XC440C – XC440D	124
Controller for managing up to 6 compressors or fans	XC460D	124
Controllers for simultaneous management of up to 5 comp. and fans	XC642 – XC650C	124
<b>XC200L - up to 6 screw compressor and 4 fan output industrial applications – serial output</b>		<b>125</b>
Controllers for managing up to 6 compressors and 4 fans	XC260L – XC261L	127
Keyboard for XC200L controllers	VI620	127
<b>XC700/800/900M - up to 11 compressor/fan output applications – serial output</b>		<b>128</b>
Controller for managing up to 6 compressors or fans	XC706M	130
Controllers for simultaneous management of up to 7 comp. and fans	XC807M – XC907M	131
Controllers for simultaneous management of up to 11 comp. and fans	XC811M – XC911M	131
<b>XC1000D - up to 15 compressor/fan output applications – serial output</b>		<b>132</b>
Advanced controller for simultaneous management up to 8 compressors and fans	XC1008D	136
Advanced controller for simultaneous management up to 11 compressors and fans	XC1011D	137
Advanced controller for simultaneous management up to 15 compressors and fans	XC1015D	137
VISOGRAPH programmable graphic display	VGC810	138



D: 4 DIN Rail



C: 32x74mm



## XC400/600 SERIES: CONTROLLERS FOR APPLICATIONS UP TO 6 SCREW COMPRESSOR/FAN OUTPUT – SERIAL OUTPUT

- The series are designed for compressor rack up to 6 compressors/fans
- Compressor types: multi-stages, differing power, semi-hermetic, scroll and screw
- Proportional band or neutral zone control
- Type of probes (NTC / PTC / 4÷20mA) selectable by parameter
- Low and high safety pressure-switch inputs
- Digital input for liquid level alarm
- Alarm digital input for each load
- Type of gas setting: to control temperature or pressure
- Hours run meter with maintenance warning for each stage
- 4÷20mA output for fan speed controllers or inverters
- Standard communication protocol ModBUS-RTU
- Hot key or Prog tool kit connector for a quick and easy programming
- 5VA max power absorption
- Dual display with red LED (8,0mm high) and yellow LED (5,6mm high) and 14 icons
- Standard compressor protection
- Type of refrigerants: R22, R134A, R404A, R507, R717 (others available)
- 12-14 pin disconnectable connectors for XC600 series

### HOW TO ORDER

XC400/600

A	B	C	D		E	
<b>Power supply</b>	<b>Measurement unit</b>	<b>Buzzer</b>		<b>4÷20mA</b>	<b>PWM</b>	<b>Inputs</b>
0 = 12Vac/dc 1 = 24Vac/dc 2 = 24Vac 4 = 110Vac 5 = 230Vac	C = °C F = °F B = Bar P = PSI	0 = No 1 = Yes	0	No	No	A = PP11 B = PP30 C = NTC D = PTC E = 4÷20mA F = Suction PP11; Condenser PP30
			1	No	Yes	
			2	Yes	No	
			3	Yes	Yes	



## CONNECTIONS

2 different version of terminal block are available depending on the model of the controllers:

**SCREW** for XC400

**DISCONNECTABLE** for XC600

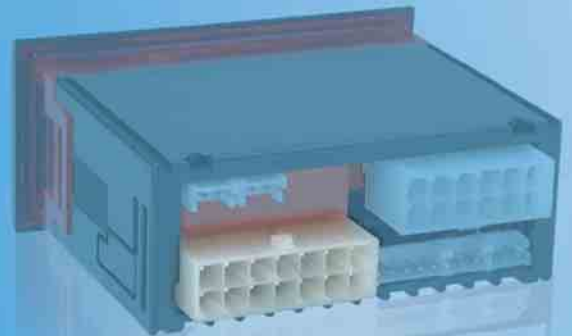

## SCREW COMPRESSORS

The XC642C is designed for screw compressors. It has a PTC probe for monitoring cylinder head temperature and control liquid injection cooling. The control algorithm can manage compressors with up to 4 steps.



## DYNAMIC SET POINT

The dynamic set point guarantees excellent plant efficiency, considering the real operative conditions. The condensing set point is changed according to the external temperature, to maintain optimum condensing temperature.

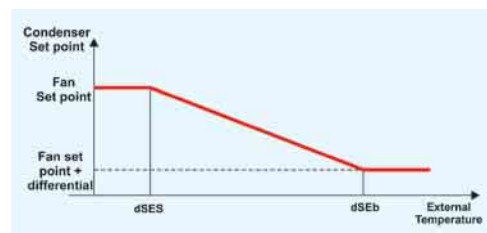

## PROPORTIONAL BAND ADJUSTMENT

A pressure value is set (set point) and an adjustment band (Pbd) is positioned over the set point. The adjustment band is then divided into equal parts, one for each stage being controlled. As the pressure increases and passes the various stages, the controller activates each load. As the pressure decreases, the loads are turned off. In this way, above the adjustment band all the compressors will be running, while below the band they will all be off. The switching on and off of the loads is carried out in such a way as to balance the run hours. The graph shows, in a simplified way, the adjustment algorithm with 4 equal loads.

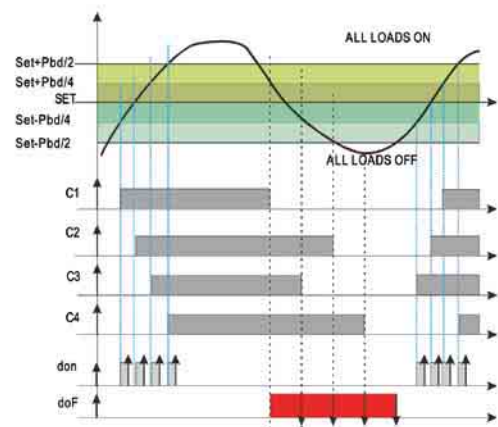

## NEUTRAL ZONE ADJUSTMENT

A pressure value (Set-point) and a band that is symmetric compared with the Set value (Pbd) can be programmed. Within this band a state of system equilibrium can exist, where the instrument will maintain the status of the outputs. If the pressure moves outside this band the switching on and off of available outputs begins, subject to delays set in parameters "don" (delay between two consecutive starts) and "doF" (delay between two consecutive stops), always respecting the protection times of each compressor. The graph illustrates, in a simplified way, neutral zone regulation with equal loads.

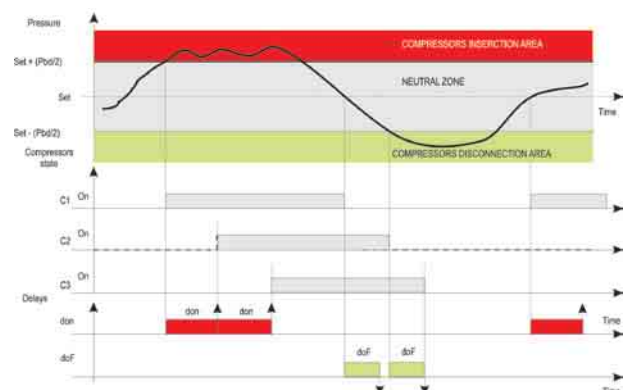

# XC400/600

## UP to 6 COMPRESSOR and/or FAN SIMULTANEOUS MANAGEMENT CONTROLLERS



C: 32x74mm

D: 4 DIN Rail

XC420C	Digital controller for managing up to 2 compressors or fans
XC440C XC440D	Digital controllers for managing up to 4 compressors or fans
XC460D	Digital controller for managing up to 6 compressors or fans
XC642C	Digital controller for managing up to 4 step screw compressors
XC650C	Digital controller for simultaneous management of up to 5 compressors and fans

FEATURES	XC420C	XC440C	XC440D	XC460D	XC642C	XC650C
<b>First display (suction): n° digits</b>	± 3 d.p.	± 3 d.p.	± 3 d.p.	± 3 d.p.	± 3 d.p.	± 3 d.p.
<b>Second display (condensing): n° digits</b>	± 4 d.p.	± 4 d.p.	± 4 d.p.	± 4 d.p.	± 4 d.p.	± 4 d.p.
<b>Power supply</b>	12, 24Vac/dc	12, 24Vac/dc	24, 110, 230Vac	24, 110, 230Vac	12, 24Vac/dc	12, 24Vac/dc
<b>Probe inputs</b>						
Regulation	NTC/PTC/4÷20mA	NTC/PTC/4÷20mA	NTC/PTC/4÷20mA		NTC/PTC/4÷20mA PTC	
Liquid injection						
Suction				NTC/PTC/4÷20mA		NTC/PTC/4÷20mA
Condensing				NTC/PTC/4÷20mA		NTC/PTC/4÷20mA
<b>Digital inputs</b>						
Low pressure switch					pres	pres
High pressure switch					pres	pres
Alarm	2	4	5	6	4	5
ON/OFF, liquid level	config	config	config		config	config
<b>Relay outputs</b>						
Loads	2 x 8A	4 x 8A	5 x 5A	6 x 5A	5 x 6A	5 x 6A
Alarm	8A	8A				
<b>Logger</b>						
Alarms	last 10	last 10	last 10	last 10	last 10	last 10
<b>Other</b>						
Hot Key/Prog Tool Kit output	pres	pres	pres	pres	pres	pres
Serial output	TTL	TTL	TTL	TTL	TTL	TTL
Alarm output					12V	12V
Triac output					trigger opt	trigger opt
Fan output			4÷20mA opt	4÷20mA opt	4÷20mA opt	4÷20mA opt
Buzzer	opt	opt	opt	opt	opt	opt

XC420C

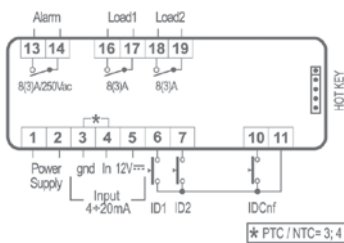

XC440C

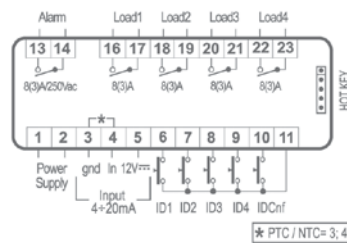

XC440D

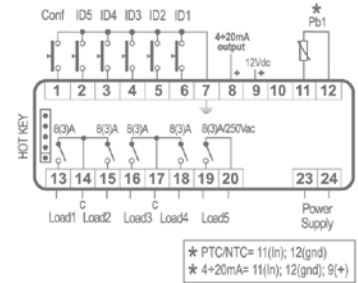

XC460D

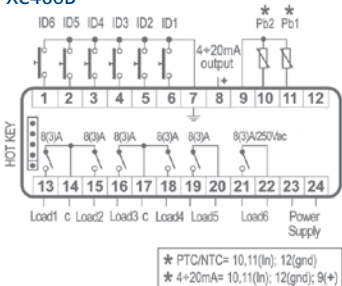

XC642C

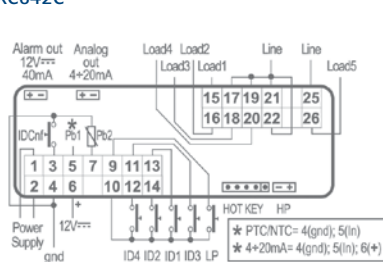

XC650C

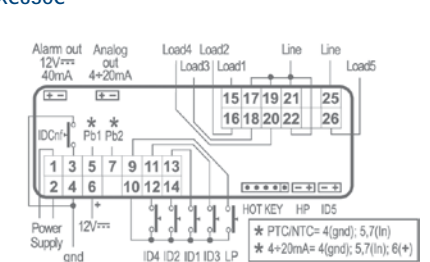



100x64mm



L: 38x185mm

## XC200L SERIES: CONTROLLERS FOR INDUSTRIAL APPLICATIONS UP TO 6 SCREW COMP. AND 4 FAN OUTPUTS – SERIAL OUTPUT

- XC200L controllers are the solution for rack compressor and fans management in industrial applications
- Scroll, semi-hermetic, multi stages, with different power and screw compressor management
- 1 compressor up to 4 capacity step management
- Simultaneous condensing pressure and suction display
- Control of condensation fan speed using a 4÷20mA or 0÷10V or PWM command
- Pump-down function (start and stop)
- Single compressor stand-by through key
- Alarm data logger (up to 100 events)
- Energy saving and ON/OFF by RTC or digital input
- Timed start and stop through RTC
- Temperature/pressure thermoregulation
- Thermoregulation of the compressors (time running hours or number of start-up per hour)
- Auxiliary relays
- Remote OFF
- Standard communication protocol ModBUS-RTU
- Hot key 64 or Prog tool kit connector for a quick and easy programming
- 10VA max power absorption
- Dual display with red LED (8,0mm high) and yellow LED (5,6mm high) and 8 icons

### HOW TO ORDER

XC200L

A	B	C	D
<b>Power supply</b>	<b>Measurement unit</b>	<b>RTC</b>	<b>Buzzer</b>
0 = 12Vac/dc 1 = 24Vac/dc	0 = °C/bar 1 = °F/PSI 2 = °C/Kpa	0 = No 1 = Yes	0 = No 1 = Yes

VI620

A	B	D
<b>Internal probe</b>	<b>Buzzer</b>	<b>Measurement unit</b>
0 = No S = Yes	0 = No 1 = Yes	0 = °C/bar 1 = °F/PSI 2 = °C/Kpa

## SCREW COMPRESSOR MANAGEMENT

Thanks to its high flexibility the XC200L can manage in the best way all the variables for a screw compressor as shown in the pictures below.

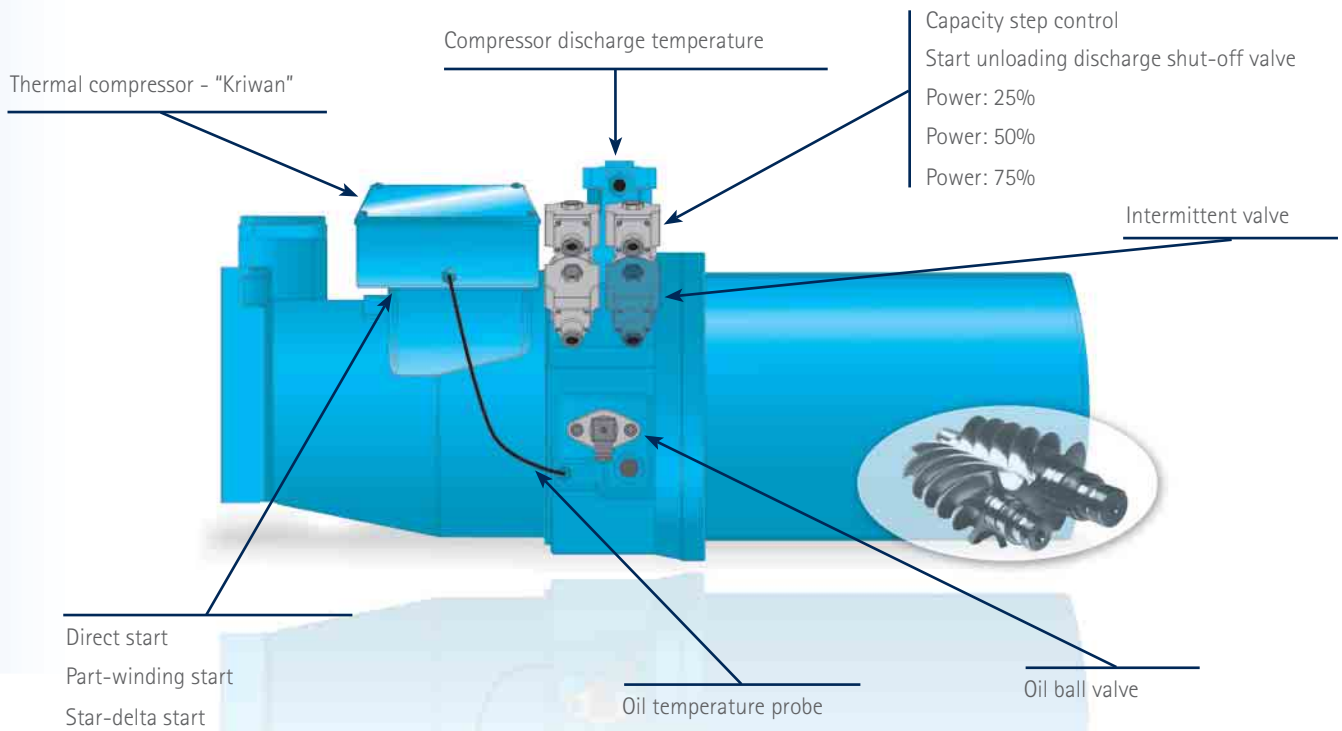

In addition:

- thermal compressor alarm management also with unit in stand-by
- cooling liquid injection with PTC probe
- high temperature alarm of the compressor discharge side with PTC probe
- oil alarm management from pressure switch or ball valve also with unit in stand-by

## PROPORTIONAL BAND ADJUSTMENT

As the pressure/temperature increases and passes the various stages (step1, step2, ...), the controller activates each load. As the pressure/temperature decreases, the loads are turned off. This way, above the adjustment band all the compressors will be running, while below the band they will all be off. The switching on and off of the loads is carried out in such a way as to balance the run hours/number of start-up per hour. The graph shows, in a simplified way, the adjustment algorithm with 6 equal loads.

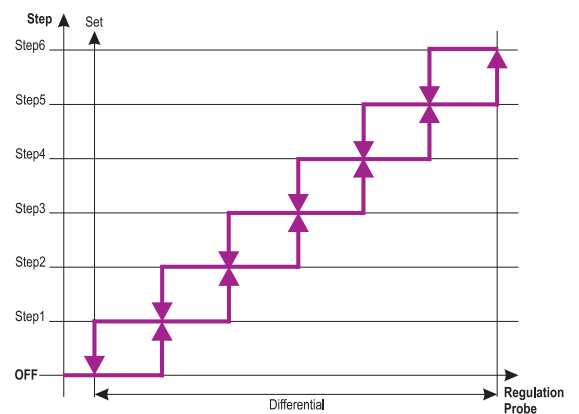

## NEUTRAL ZONE ADJUSTMENT

A pressure/temperature value (set-point) and a band can be programmed. Within this band a state of system equilibrium can exist, where the instrument will maintain the status of the outputs. If the pressure moves outside this band the switching on and off of available outputs begins, subject to delays set in dedicated parameters, always respecting the protection times of each compressor. The graph illustrates, in a simplified way, neutral zone regulation with equal loads.

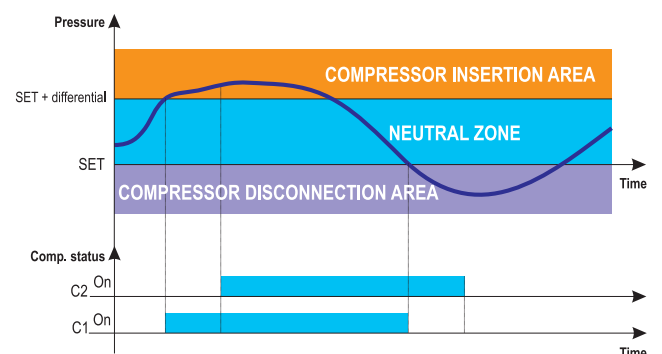

# XC200L

## ADVANCED CONTROLLERS for SIMULTANEOUS MANAGEMENT of UP to 6 COMPRESSORS and 4 FANS



L: 38x185mm

**XC260L**

Advanced digital controller for industrial applications compressor racks with up to 6 compressors and 4 fans or 1 compressor and 4 capacity step control simultaneous management

**XC261L**

Advanced digital controller for industrial applications compressor racks with 14 relay outputs and with up to 6 compressors and 4 fans or 1 compressor and 4 capacity step control simultaneous management

FEATURES	XC260L	XC261L
<b>First display: n° digits</b>	± 3 d.p.	± 3 d.p.
<b>Second display: n° digits</b>	± 4 d.p.	± 4 d.p.
<b>Keyboard: push buttons</b>	6	6
<b>Power supply</b>	12, 24Vac/dc	12, 24Vac/dc
<b>Probe inputs</b>		
Thermoregulation	10 x NTC/PTC/4÷20mA/0÷5V config	10 x NTC/PTC/4÷20mA/0÷5V config
<b>Digital inputs</b>		
Security	18 config	18 config
<b>Relay outputs</b>		
Loads	10 x 5A config	14 x 5A config
<b>Other</b>		
Hot Key 64/Prog Tool Kit output	pres	pres
Remote keyboard (up to 2) output	VI620	VI620
Serial output	TTL	TTL
Outputs for condensing fan	2 x PWM e 2x0÷10V/4÷20mA config	2 x PWM e 2x0÷10V/4÷20mA config
Analog outputs for free cooling, heat recovery, external relay	4 x 0÷10V config	4 x 0÷10V config
Buzzer	opt	opt
Real time clock	opt	opt

XC260L

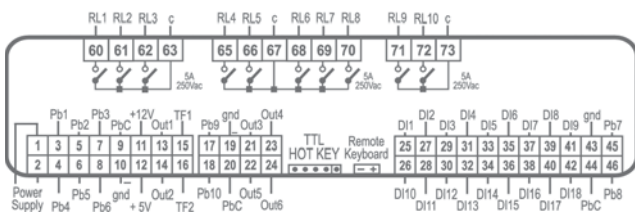

XC261L

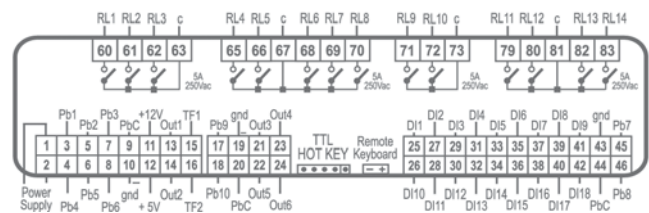

# XC200L

## KEYBOARD for XC200L CONTROLLERS



100x64mm

**VI620**

6 key keyboard for XC200L controllers

**First display: n° digits**  
**Second display: n° digits**  
**Keyboard: push buttons**  
**Power supply**  
**Buzzer**

± 3 d.p.  
 ± 4 d.p.  
 6  
 from controller  
 opt



## XC700/800/900M SERIES: CONTROLLERS FOR APPLICATIONS UP TO 11 COMP./FAN OUTPUTS – SERIAL OUTPUT

- The XC700/800/900M series are designed for application involving the control and management of compressors and fans in compressor racks
- Management of compressor racks with up to 9 compressors and 6 fans (max 11 loads)
- Proportional band or dead band control
- Load activation: in set sequence or with automatic rotation
- Delay times and safeties setting
- Temperature and pressure display depending of the gas (also for ammonia)
- Reduced set point for energy saving management
- Alarm input management: for each load, high and low pressure switch, liquid level
- Operating data recording: pressure and loads
- Last 10 alarms recording: kind of alarm, date and time for service calling
- Graph and operating data printing via infrared, together with parameters and alarms (XC900M)
- Built in run time meters for each stage + "maintenance due" signal
- Standard communication protocol ModBUS-RTU
- Hot key or Prog tool kit connector for a quick and easy programming
- 12VA max power absorption
- Dual display with red LED (13,2mm high), green LED (13,2mm high)
- Standard compressor protection
- Type of refrigerant: R22, R134A, R404A, R507, R717 (other available)
- Resolution: 1/100 bar for suction, 1/10 bar for condensing

### HOW TO ORDER

XCM  X  C    M -  A  B  O  D  E

A	B	D	E
<b>Power supply</b>	<b>Input</b>	<b>Measurement unit</b>	<b>Extended memory for infrared</b>
<b>2</b> = 24Vac <b>4</b> = 110Vac <b>5</b> = 230Vac	<b>A</b> = Suction PP07; Condensing PP30 <b>B</b> = Suction PP07; Condensing NTC <b>C</b> = Suction NTC; Condensing PP30 <b>D</b> = Suction PP11; Condensing NTC <b>E</b> = Suction PP11; Condensing PP30 <b>N</b> = NTC	<b>1</b> = Bar - °C <b>2</b> = PSI - °F <b>3</b> = KPA - °C	<b>0</b> = No <b>1</b> = Yes



Typical alarm list printout

```

Dixell-XC911M
Alarm List

Code      From          To
A14F 15:02 29/06 15:04 29/06
A14F 15:01 29/06 15:02 29/06
A04C 12:13 29/06 12:14 29/06
A01F 11:54 29/06 11:59 29/06

Index:
Er0L Low pressure-switch alarm
Er0H High pressure-switch alarm
A01C Suction probe alarm
A01F Condensing probe alarm
A02C Compr. digit. input alarm
A02F Fan digital input alarm
A03C Suction low pressure alarm
A04C Suction high press. alarm
A03F Condensing low press. alr
A04F Condensing high press. alr
A05 Liquid level alarm
A11F Clock faulty
A11L Data clock lost
A12 Output number not valid
A13L EEPROM data not valid
A13F EEPROM broken (service)
A14C Compr maintenance call
A14F Fan maintenance call

Print date:02/07/2008
Print time:09:20
    
```

Printout concerning the behaviour of loads and temperature/pressure

```

Dixell-XC911M
Graphics Print

Section: Suction
Range: -25.3 - -14.7 °C
nz/db: 10.0 °C
Set Point: -20.0 °C
Interval: 1 Sec
Marker Int: 00:30 (mm:ss)
Start date: 06/07/2008 14:05:56
End date: 06/07/2008 14:08:11

Power:
Temperature:

Print date:06/07/2008
Print time:14:08
    
```

Parameter printout

```

Type:Compressor (Cnf)
Label Value M.U. Range
*****
CpNu 5 Num 1/5
CtyP 1 Num 0/1
CPSt 1 Num 1/1
rty bP Flag db/ bP
Sty F Flag rt/ F
FtyP r404 Num r22/ 134
Pbc ntC Num Cur/ntC
CAL 0.02 Num -1.00/1.00
SEP 1 Flag 0/1
rSIP 1 Flag 0/1
LLI 1 Flag 0/1
ALIP 1 Flag 0/1
StPP 1 Flag 0/1
Psc 0 Num 0/255

Type:Fan (Cnf)
Label Value M.U. Range
*****
nFn 6 Num 0/6
Pbc ntC Num Cur/ntC
CAL 0.05 Num -1.00/1.00
SEP 1 Flag 0/1
Psc 0 Num 0/255

Type:Fan (Opr)
Label Value M.U. Range
*****
SetN 10.68 Bar 7.07/28.87
SetR 14.02 Bar 7.07/28.87
dEU bAr Flag bAr/ °C
Pbd 2.00 Bar 0.10/5.00
don 4 Sec 0/255
doF 9 Sec 0/255
rot no Flag no/YES
LSE 7.07 Bar 2.52/28.86
HSE 28.87 Bar 7.06/28.87
LAL 6.09 Bar 0.00/5.68
HAL 8.99 Bar 0.00/24.32
tAo 0 Min 0/255
PEn 9 Num 0/15
PEI 10 Min 1/15
FPP 0 Flag 0/1
FPr 3 Num 0/6
rELP AbS Num AbS/rEL
PSO 0 Num 0/255

Print date:12/07/2008
Print time:16:34
    
```



XC09PR: an infrared thermal printer suitable for XC900M compressor racks controllers. Can print alarms, parameters and data recorded by the instrument

## PROPORTIONAL BAND ADJUSTMENT

A pressure value is set (set point) and an adjustment band (Pbd) is positioned over the set point. The adjustment band is then divided into equal parts, one for each stage being controlled. As the pressure increases and passes the various stages, the controller activates each load. As the pressure decreases, the loads are turned off. In this way, above the adjustment band all the compressors will be running, while below the band they will all be off. The switching on and off of the loads is carried out in such a way as to balance the run hours. The graph shows, in a simplified way, the adjustment algorithm with 4 equal loads.

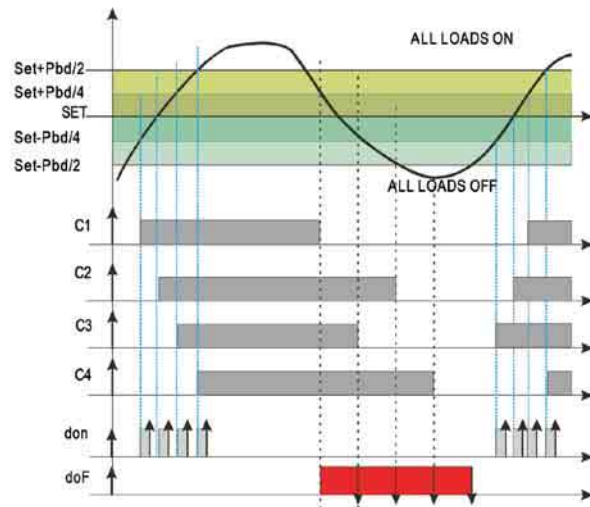

## NEUTRAL ZONE ADJUSTMENT

A pressure value (Set-point) and a band that is symmetric compared with the Set value (Pbd) can be programmed. Within this band a state of system equilibrium can exist, where the instrument will maintain the status of the outputs. If the pressure moves outside this band the switching on and off of available outputs begins, subject to delays set in parameters "don" (delay between two consecutive starts) and "doF" (delay between two consecutive stops), always respecting the protection times of each compressor. The graph illustrates, in a simplified way, neutral zone regulation with equal loads.

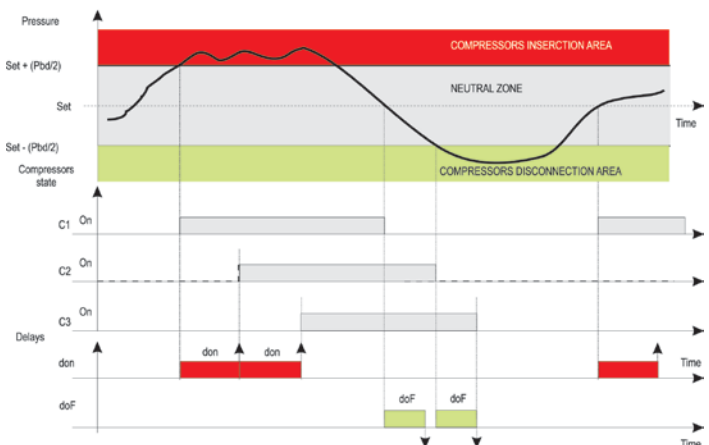

# XC700/800/900M

## CONTROLLERS for MANAGING UP to 6 COMPRESSORS or FANS



M: 72x144mm

**XC706M**

Digital controller with up to 6 outputs for compressor racks

FEATURES	XC706M
First display (suction/temperature): n° digits	4 d.p.
Second display (suction/pressure): n° digits	4 d.p.
Power supply	24, 110, 230Vac
<b>Probe inputs</b>	
Suction	NTC/4÷20mA
Condensing	
<b>Digital inputs</b>	
Low pressure switch	pres
High pressure switch	
Liquid level	pres
Load safety	6
<b>Relay outputs</b>	
Loads	6 x 8A
Alarms	2 x 8A
<b>Logger</b>	
Alarms	last 10
Data	
<b>Other</b>	
Hot Key/Prog Tool Kit output	pres
Serial output	RS485
Infrared output	
Reduced set point	pres
Buzzer	pres
Real time clock	pres

### XC706M

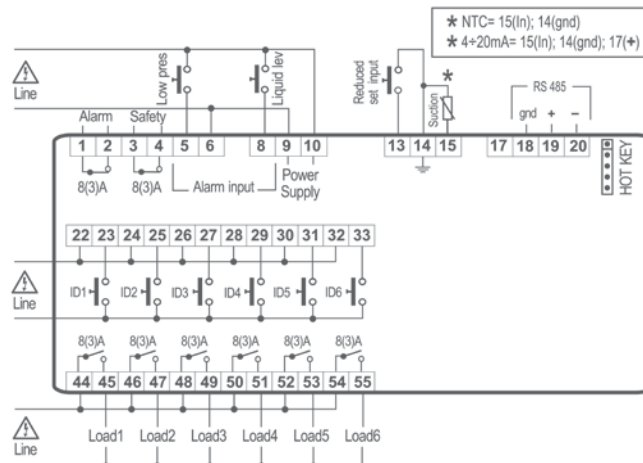

# XC700/800/900M

## CONTROLLERS for the SIMULTANEOUS MANAGEMENT of UP to 11 COMPRESSORS or FANS



M: 72x144mm

<b>XC807M</b>	Digital controller with up to 7 outputs for compressor racks
<b>XC811M</b>	Digital controller with up to 11 outputs for compressor racks
<b>XC907M</b>	Digital controller with up to 7 outputs for compressor racks plus data recording
<b>XC911M</b>	Digital controller with up to 11 outputs for compressor racks plus data recording

FEATURES	XC807M	XC811M	XC907M	XC911M
<b>First display (suction): n° digits</b>	4 d.p.	4 d.p.	4 d.p.	4 d.p.
<b>Second display (condensing): n° digits</b>	4 d.p.	4 d.p.	4 d.p.	4 d.p.
<b>Power supply</b>	24, 110, 230Vac	24, 110, 230Vac	24, 110, 230Vac	24, 110, 230Vac
<b>Probe inputs</b>				
Suction	NTC/4÷20mA	NTC/4÷20mA	NTC/4÷20mA	NTC/4÷20mA
Condensing	NTC/4÷20mA	NTC/4÷20mA	NTC/4÷20mA	NTC/4÷20mA
<b>Digital inputs</b>				
Low pressure switch	pres	pres	pres	pres
High pressure switch	pres	pres	pres	pres
Liquid level	pres	pres	pres	pres
Load safety	7	11	7	11
<b>Relay outputs</b>				
Loads	7 x 8A	11 x 8A	7 x 8A	11 x 8A
Alarms	2 x 8A	2 x 8A	2 x 8A	2 x 8A
<b>Logger</b>				
Alarms	last 10	last 10	last 10	last 10
Data			pressure, loads	pressure, loads
<b>Other</b>				
Hot Key/Prog Tool Kit output	pres	pres	pres	pres
Serial output	RS485	RS485	RS485	RS485
Infrared output			pres	pres
Reduced set point	pres	pres	pres	pres
Buzzer	pres	pres	pres	pres
Real time clock	pres	pres	pres	pres

XC807M  
XC907M

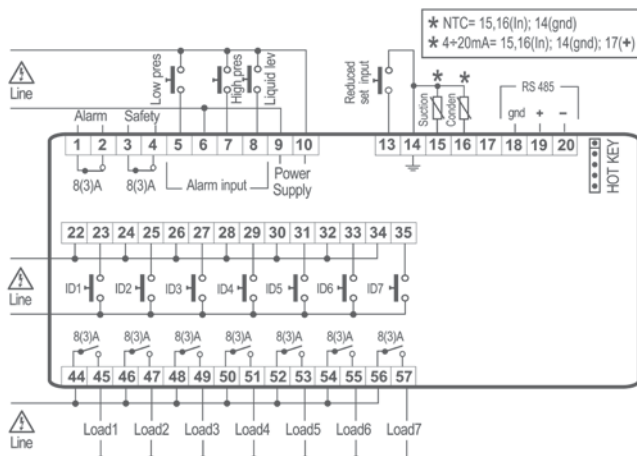

XC811M  
XC911M

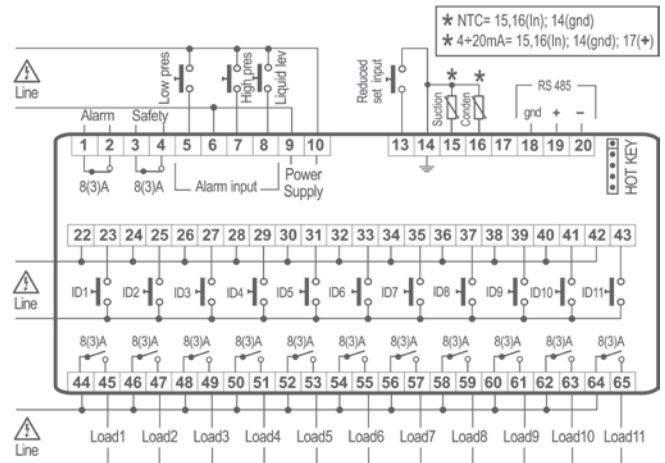



D: 10 DIN Rail



82x156mm

## XC1000D SERIES: CONTROLLERS FOR APPLICATIONS UP TO 15 COMPRESSOR/FAN OUTPUTS – SERIAL OUTPUT

- XC1000D series for compressors and condensing fans monitoring and management of medium-large compressor racks
- VISOGRAPH programmable graphic display (LCD – 240x96 pixel)
- Scroll, semi-hermetic, multi stages, with different power and screw compressor management
- Proportional band or dead band control
- Temperature and pressure display depending on the gas (Freon, NH<sub>3</sub>, CO<sub>2</sub> ...)
- Concise information about the variables of the compressor rack through the VISOGRAPH display
- Great versatility and extensive customization opportunities
- 2 analogue outputs for frequency compressors
- 2 analogue outputs for inverter for fans
- Reduced set point for energy saving management
- Hourly run time signals for maintenance
- Dynamic set point for energy saving
- Sub-cooling management
- Last 100 alarm conditions storage and display
- Special algorithms for energy saving
- Standard communication protocol ModBUS-RTU
- Hot key or Prog tool kit connector for a quick and easy programming
- 12VA max power absorption
- Type of refrigeratant gas: R22, R134A, R404A, R507, R717
- Resolution 1/100bar, 1/10°C, 1°F, 1PSI

### HOW TO ORDER

XC1000D [X] [C] [1] [0] [ ] [ ] [D] [-] [1] [B] [0] [D] [E]

B	D	E
<b>Measurement unit</b>	<b>4÷20mA</b>	<b>Input</b>
C = °C F = °F B = Bar P = PSI K = Kpa	0 = No 1 = Yes	C = NTC D = PTC E = 4÷20mA F = Suction PP11; Delivery PP30 G = Ratiometric

VISOGRAPH [V] [G] [C] [8] [1] [0] [-] [A] [B] [0] [0] [0]

A	B
<b>Buzzer</b>	<b>Kind of mounting</b>
0 = No 1 = Yes	P = Panel W = Wall

## KINDS OF CIRCUIT

The XC1000D series is able to manage in the best possible way the majority of applications for refrigeration circuits.

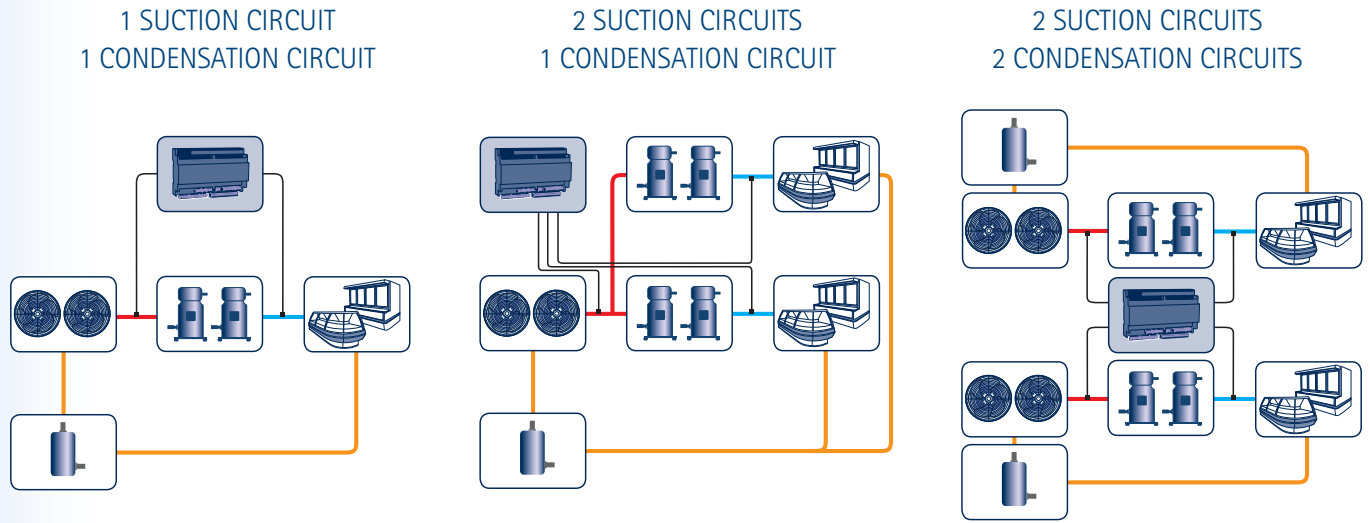

## CO<sub>2</sub> REGULATION

CO<sub>2</sub> use is increasing thanks to the advantages it offers in cooling plants. For this reason there is also a greater demand for accessories. Thanks to special algorithms and an appropriate pressure range, the XC1000D series can manage and monitor CO<sub>2</sub> plants that work in cascade connection with sub-critical cycle.



## STANDARD REGULATION

### NEUTRAL ZONE ADJUSTMENT

A pressure value (set-point) and a band that is symmetric compared with the set value can be programmed. Within this band a state of system equilibrium can exist, where the instrument will maintain the status of the outputs. If the pressure moves outside this band the switching on and off of available outputs begins, subject to delays set in the parameters "delay between two consecutive starts" and "delay between two consecutive stops", always respecting the protection times of each compressor. The graph illustrates, in a simplified way, neutral zone regulation with equal loads.

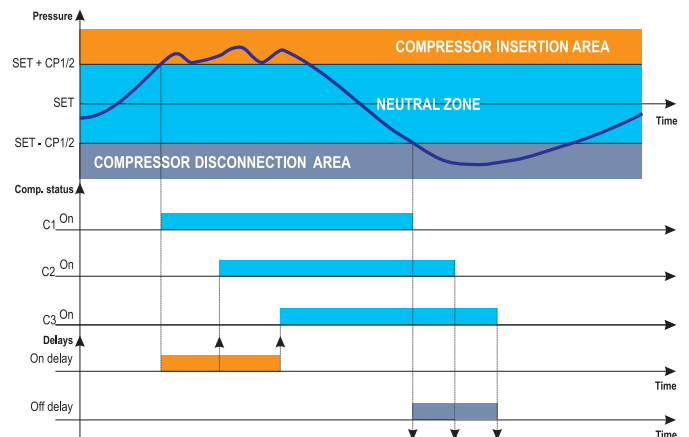
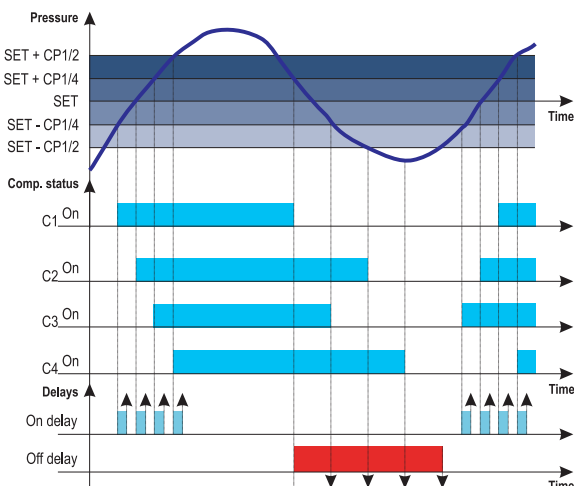

### PROPORTIONAL BAND ADJUSTMENT

A pressure value is set (set point) and an adjustment band is positioned over the set point. The adjustment band is then divided into equal parts, one for each stage being controlled. As the pressure increases and passes the various stages, the controller activates each load. As the pressure decreases, the loads are turned off. In this way, above the adjustment band all the compressors will be running, while below the band they will all be off. The switching on and off of the loads is carried out in such a way as to balance the running hours. The graph shows, in a simplified way, the adjustment algorithm with 4 equal loads.

## ENERGY SAVING MANAGEMENT

The new XC1000D series gives to the user several solutions that let you to manage energy savings, so important when we deal with "compressor management". The controllers have a special algorithm that lets you to optimize the efficiency of the plant, ensuing energy savings. The following are a range of the most important solutions that Dixell offers to customers to achieve energy savings.

### COMPRESSORS WITH INVERTER

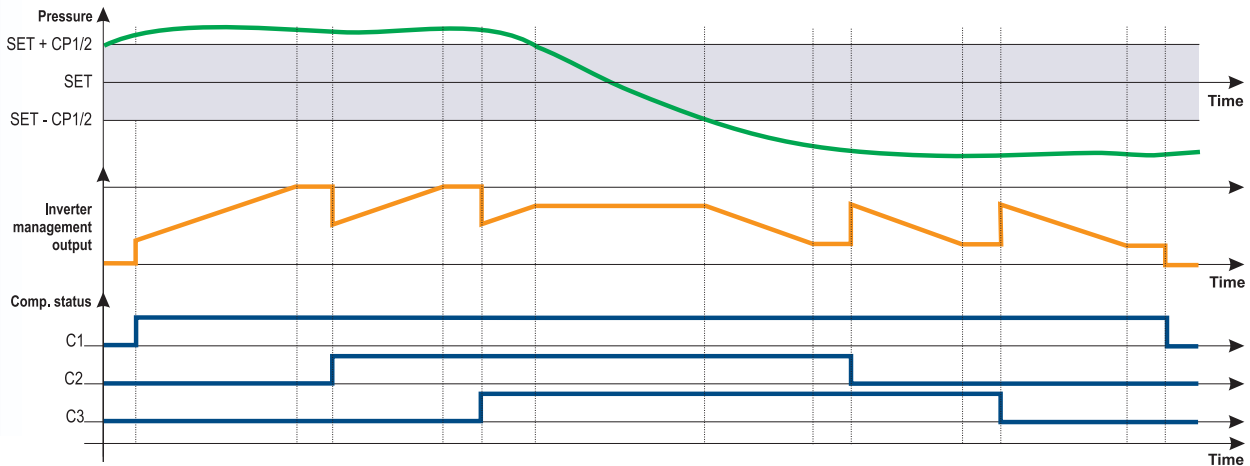

When the plant needs more power (when the temperature gets out of the band) the inverter compressor (C1) frequency increases. If this is not enough, the other compressors (C2, C3, ...) will be activated in sequence. At the same time the controller will modulate the inverter compressor frequency in order to have a uniform increase of the plant power.

### FANS WITH INVERTER

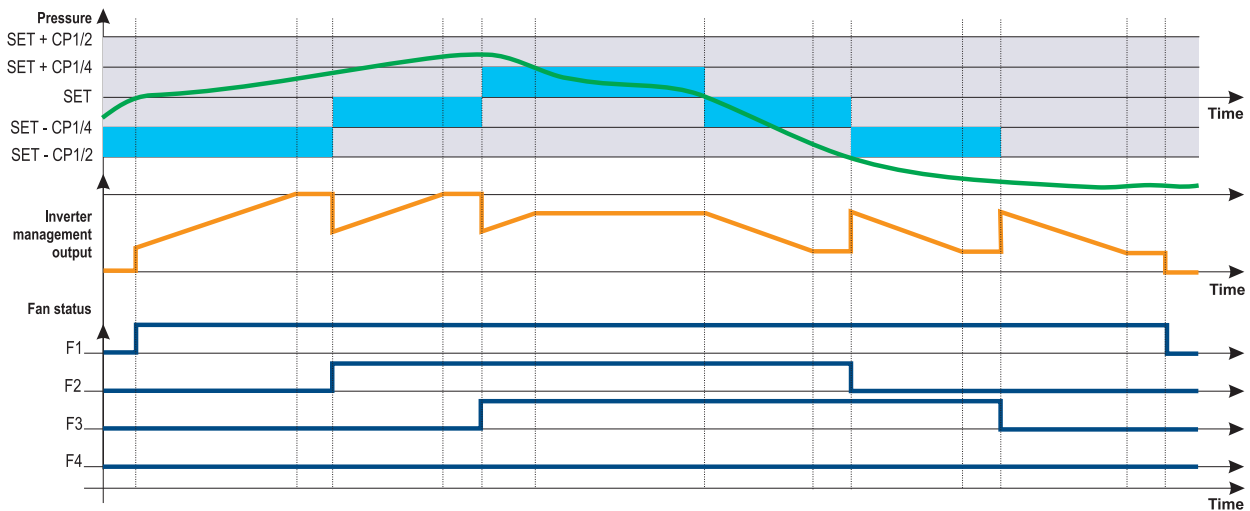

When the plant needs more power (when the temperature gets out of the band) the inverter fan (F1) frequency increases. If it is not enough, the other fans (F2, F3, ...) will be activated in sequence. At the same time the controller will modulate the inverter fan frequency in order to have a uniform increase of the plant power.

## SUCTION DYNAMIC SET POINT

**Suction temperature/pressure optimization can depend on retail space temperature.**

The dynamic set point guarantees excellent plant efficiency, considering the real operational conditions. The plant modifies the suction temperature/pressure according to the retail space temperature so the refrigeration power changes depending on the real thermodynamic exchange.

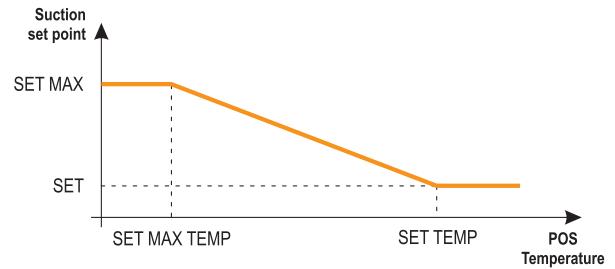

## CONDENSER DYNAMIC SET POINT

**Condenser temperature/pressure optimization can depend on the external temperature.**

The condenser temperature/pressure is modified according to the external temperature. The condensing set point is automatically adjusted according to the external temperature, to get an optimum condensing temperature.

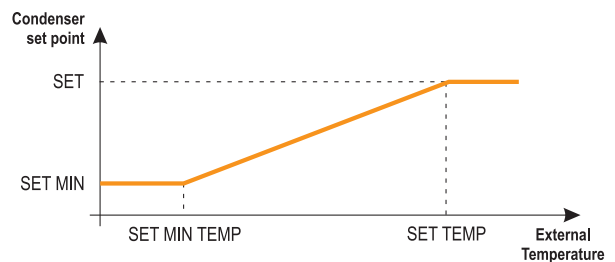

## REDUCED SET POINT

An internal 7 day clock can automatically change the adjustment's set point, depending on a particular system's individual requirements, to enter an energy saving cycle during nights and weekends, when less power is required. This energy saving cycle can also be initiated from an external source via a digital input.

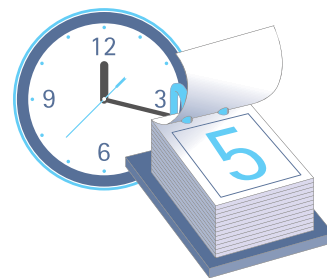

## SUPERVISION SET

The connection to the modern supervising systems (of Dixell) allows, thanks to the CRO special algorithm (Compressor Rack Optimization), to manage in the best way the compressor rack set point depending on the devices connected, with the result of having an optimized energy saving on the plant. The system, equipped with the CRO function, analyzes the information from the controller in the application to determine if a controller needs more refrigeration power and the quantity. The set point will be re-calculated in order to satisfy the worse instance and sent from the supervising system to the XC1000D; this will be the working set point (fig. 1). If the supervising system can't manage the XC1000D, is the controller that "decided" to replace the set point (coming from the system) and will then define the set point in the program phase.

The 2 graphs (fig. 2) emphasize that when the CRO algorithm is active, in a real installation, the set point becomes on average higher, and consequently the energy consumption decreases. The dotted line represents the average weekly value.

fig. 1

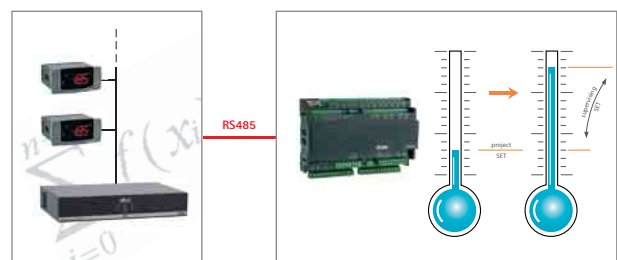
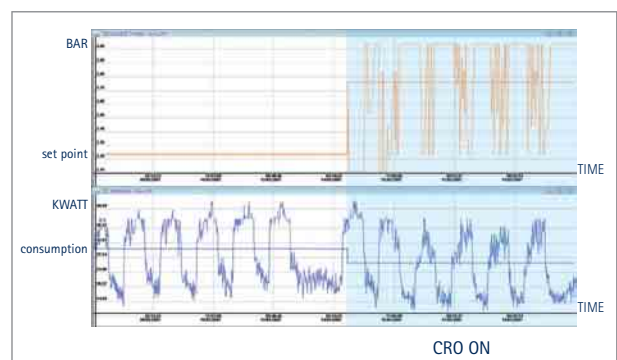

fig. 2



# XC1000D

## ADVANCED CONTROLLERS for the SIMULTANEOUS MANAGEMENT of UP to 8 COMPRESSORS and FANS



D: 10 DIN Rail

XC1008D

Advanced digital controller for compressor racks with up to 8 compressors and fans simultaneous management

FEATURES	XC1008D
<b>Power supply</b>	24Vac/dc (from TF10D)
<b>Probe inputs</b>	
Suction 1	NTC/PTC/4÷20mA/0÷5V
Suction 2	
Condensing 1	NTC/PTC/4÷20mA/0÷5V
Condensing 2	
Auxiliary 1	NTC/PTC
Auxiliary 2	NTC/PTC
Auxiliary 3	
Auxiliary 4	
<b>Digital inputs</b>	
Low pressure switch 1 (main voltage)	pres
Low pressure switch 2 (main voltage)	
High pressure switch 3 (main voltage)	pres
High pressure switch 4 (main voltage)	
Safety loads (main voltage)	8
Free of voltage	4 config
<b>Relay outputs</b>	
Loads	8 x 7A config
Alarms	2 x 8A
<b>Other</b>	
Hot Key/Prog Tool Kit output	pres
Remote display output	VGC810
Serial output	RS485
Inverter compressor output	4÷20mA/0÷10V opt
Inverter fan output	4÷20mA/0÷10V opt
Buzzer	on keyboard opt
External module connections	LAN opt

### XC1008D

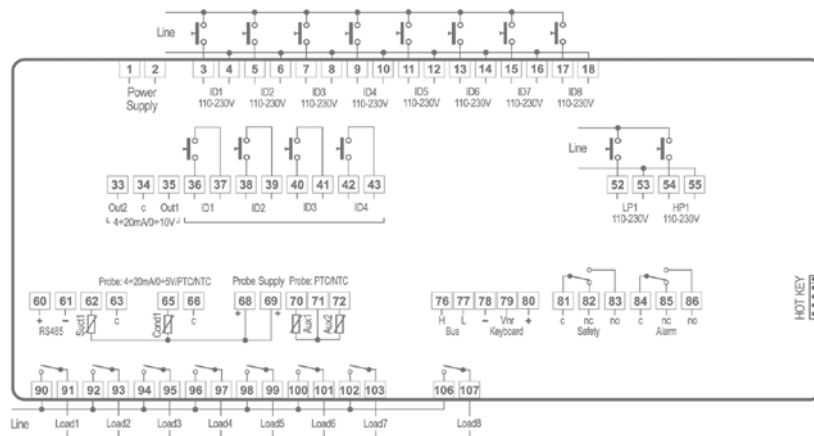



# XC1000D

## ADVANCED CONTROLLERS for the SIMULTANEOUS MANAGEMENT of UP to 15 COMPRESSORS and FANS



D: 10 DIN Rail

**XC1011D**

Advanced digital controller for compressor racks with simultaneous management up to 11 compressors and fans

**XC1015D**

Advanced digital controller for compressor racks with simultaneous management up to 15 compressors and fans

FEATURES	XC1011D	XC1015D
<b>Power supply</b>	24Vac/dc (from TF20D)	24Vac/dc (from TF20D)
<b>Probe inputs</b>		
Suction 1	NTC/PTC/4÷20mA/0÷5V	NTC/PTC/4÷20mA/0÷5V
Suction 2	NTC/PTC/4÷20mA/0÷5V	NTC/PTC/4÷20mA/0÷5V
Condensing 1	NTC/PTC/4÷20mA/0÷5V	NTC/PTC/4÷20mA/0÷5V
Condensing 2	NTC/PTC/4÷20mA/0÷5V	NTC/PTC/4÷20mA/0÷5V
Auxiliary 1	NTC/PTC	NTC/PTC
Auxiliary 2	NTC/PTC	NTC/PTC
Auxiliary 3	NTC/PTC	NTC/PTC
Auxiliary 4	NTC/PTC	NTC/PTC
<b>Digital inputs</b>		
Low pressure switch 1 (main voltage)	pres	pres
Low pressure switch 2 (main voltage)	pres	pres
High pressure switch 3 (main voltage)	pres	pres
High pressure switch 4 (main voltage)	pres	pres
Safety loads (main voltage)	11	15
Free of voltage	4 config	4 config
<b>Relay outputs</b>		
Loads	11 x 7A config	15 x 7A config
Alarms	2 x 8A	2 x 8A
<b>Other</b>		
Hot Key/Prog Tool Kit output	pres	pres
Remote display output	VGC810	VGC810
Serial output	RS485	RS485
Inverter compressor output	2 x 4÷20mA/0÷10V opt	2 x 4÷20mA/0÷10V opt
Inverter fan output	2 x 4÷20mA/0÷10V opt	2 x 4÷20mA/0÷10V opt
Buzzer	on keyboard opt	on keyboard opt
External module connections	LAN opt	LAN opt

XC1011D  
XC1015D

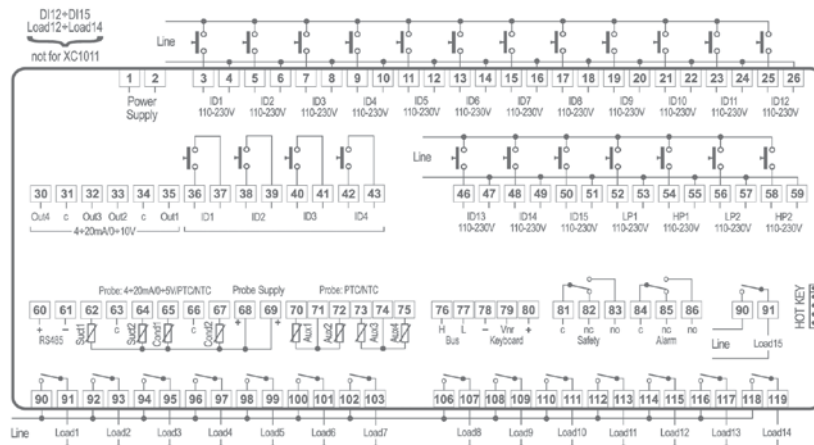

# VISOGRAPH

## PROGRAMMABLE GRAPHIC DISPLAY



82x156mm

VGC810

Programmable graphic display (LCD – 240x96pixel) for XC1000D controllers

### FEATURES

VGC810

#### For models

XC1008D  
XC1011D  
XC1015D

#### Power supply VISOKEY output

from controller  
pres

#### Buzzer

opt

#### Mounting

wall or panel

- Great versatility and extensive customization opportunities
- IP65 front protection
- Keyboard lock function
- Easy programming through VISOKEY

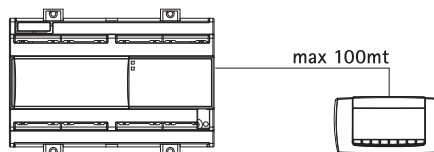

VISOGRAPH keyboards can be wall or panel mounted

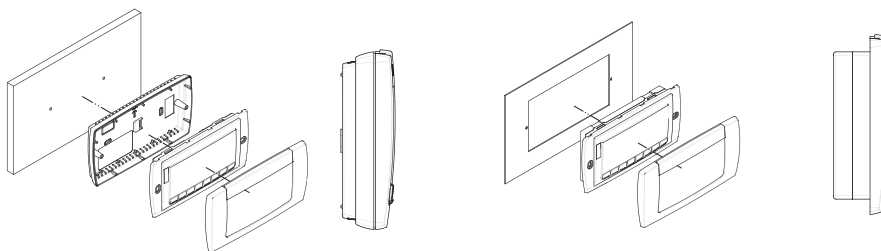

VISOGRAPH keyboards instantly provide complete information about the machine variables

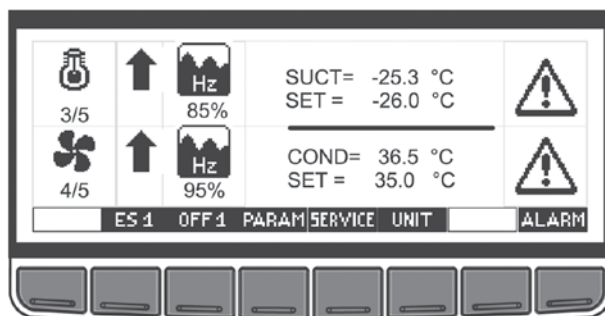

## VISOKEY

Key to transfer programs on VGC810 keyboard





## REFRIGERATED TRUCK CONTROLLERS

### SECTION INDEX

FUNCTIONS	MODELS	
<b>XW20/35/40/60/300</b> - NT, MT and LT applications – compact/split format		<b>140</b>
Multifunction controller for refrigerated trucks with "off cycle" defrost	XW20L	141
Multifunction controllers for refrigerated trucks with N.T. – M.T. – L.T.	XW35L - XW40L	141
Multifunction controller for refrigerated trucks with M.T. – L.T.	XW60L	141
Advanced multifunction controllers for refrigerated trucks with M.T. – L.T.	XW360K - XW370K	142
Keyboard for advanced multifunction controllers in K format	T630	142



L: 38x185mm



38x185mm

## XW20/35/40/60/300 SERIES: CONTROLLERS FOR NT, MT AND LT APPLICATIONS – COMPACT/SPLIT FORMAT

- Multifunction controllers in compact and split format designed for refrigerated trucks (8-40Vdc power supply)
- Up to 6 push buttons with direct action for user friendly interface
- Maximum and minimum temperature recording
- Possibility of controlling one LT and one NT compartment or one refrigerated and one heated compartment (XW300)
- 3 operating modes: cooling, heating and neutral zone (XW300)
- "on demand" defrost for optimum defrost cycles management (XW300)
- Service hours count for system maintenance cycles (XW300)
- Thermostatic command for shutter opening (XW300)
- Hot Key or Prog tool kit connector for a quick and easy programming
- 3VA max power absorption (10VA max for XW300)
- Display with red LED (13,2 mm high)

### HOW TO ORDER

XW20/35/40/60

X W [ ] [ ] L - 3 B C D O - N



For Inox version and blue display please contact Dixell

B	C	D
<b>Input</b>	<b>Buzzer</b>	<b>Measurement unit</b>
N = NTC P = PTC	0 = No 1 = Yes	C = °C F = °F

KEYBOARD

T 6 3 0 - A 0 0 D 0



For Inox version and blue display please contact Dixell

A	D
<b>Buzzer</b>	<b>Measurement unit</b>
0 = No 1 = Yes	C = °C F = °F

XW300

X W 3 [ ] O K - 3 N C D E

C	D	E	
<b>Housing</b>	<b>Measurement unit</b>	<b>Built-in RS485</b>	<b>4÷20mA</b>
0 = Open board "OS" 2 = "GS" housing 182x142x76mm 4 = "GS" housing 225x180x84mm	C = °C F = °F	0 No 2 No 4 Yes 6 Yes	No Yes No Yes

# XW20/35/40/60

## MULTIFUNCTION CONTROLLERS for REFRIGERATED TRUCKS with NORMAL, MEDIUM and LOW TEMPERATURE



L: 38x185mm

<b>XW20L</b>	Multifunction controller for refrigerated trucks with N.T., "off cycle" defrost and light relay
<b>XW35L</b>	Multifunction controller for refrigerated trucks with N.T., "off cycle" defrost, light relay and fan relay
<b>XW40L</b>	Multifunction controller for refrigerated trucks with M.T. - L.T., defrost management and light relay
<b>XW60L</b>	Multifunction controller for refrigerated trucks with M.T. - L.T. ventilated applications, defrost management and light relay

FEATURES	XW20L	XW35L	XW40L	XW60L
<b>Display: n° digits</b>	± 3 d.p.	± 3 d.p.	± 3 d.p.	± 3 d.p.
<b>Keyboard: push buttons</b>	6	6	6	6
<b>Power supply</b>	8-40Vdc	8-40Vdc	8-40Vdc	8-40Vdc
<b>Probe inputs</b>				
Thermostat	NTC/PTC	NTC/PTC	NTC/PTC	NTC/PTC
Defrost			NTC/PTC	NTC/PTC
<b>Digital inputs</b>				
Alarm, start defrost, door switch, pressure switch	config	config	config	config
<b>Relay outputs</b>				
Compressor	8A	8A	8A	8A
Defrost			8A	8A
Fans		8A		8A
Light	8A	8A	8A	8A
<b>Other</b>				
Hot Key/Prog Tool Kit output	pres	pres	pres	pres
Buzzer	opt	opt	opt	opt

**XW20L**

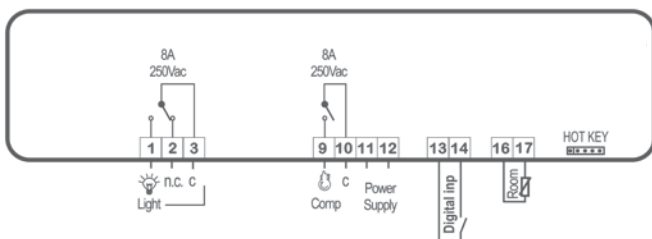

**XW35L**

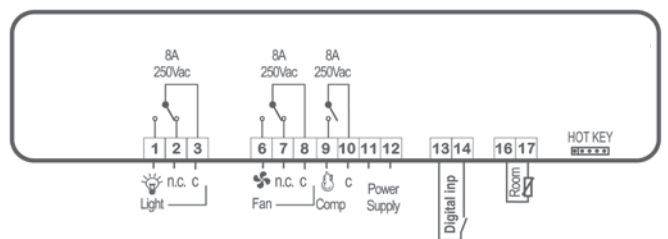

**XW40L**

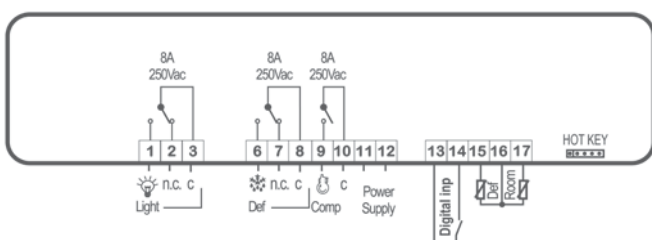

**XW60L**

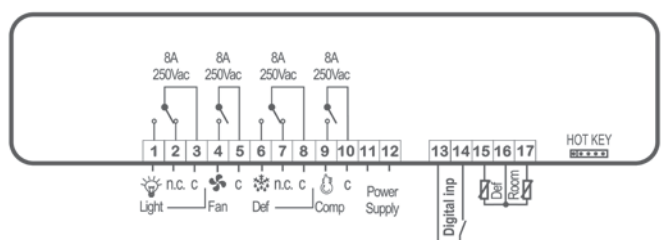

# XW300

## MULT. CONTR. for REFRIG. TRUCKS with MT – LT and KEYBOARD for ADVANCED MULT. CONTR. in K FORMAT



K: OS/GS

**XW360K**

Multifunction digital controller for refrigerated trucks with M.T. – L.T. ventilated applications

**XW370K**

Multifunction digital controller for refrigerated trucks with M.T. – L.T. ventilated applications, heater and shutter management

FEATURES	XW360K	XW370K
<b>Display: n° digits</b>	± 3 d.p.	± 3 d.p.
<b>Keyboard: push buttons</b>	T630: 6	T630: 6
<b>Power supply</b>	8-40Vdc	8-40Vdc
<b>Probe inputs</b>		
Thermostat	NTC	NTC
NT thermostat		NTC
Defrost	NTC	NTC
"on demand" defrost (odd)	NTC	NTC
<b>Digital inputs</b>		
Generic alarm, block alarm, pressure switch, start defrost, change working mode, heater output	config	config
Door switch	pres	pres
<b>Relay outputs</b>		
Compressor	8A	8A
Defrost	8A	8A
Fans	8A	8A
Heater control		8A
Light	8A	8A
Shutter		8A
<b>Other</b>		
Hot Key/Prog Tool Kit output	pres	pres
Serial output	RS485 opt	RS485 opt
Analog output	4÷20mA opt	4÷20mA opt
Buzzer	on keyboard opt	on keyboard opt

**XW360K**

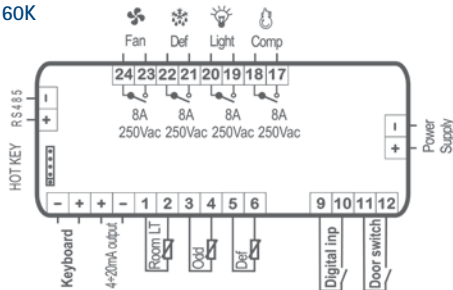

**XW370K**

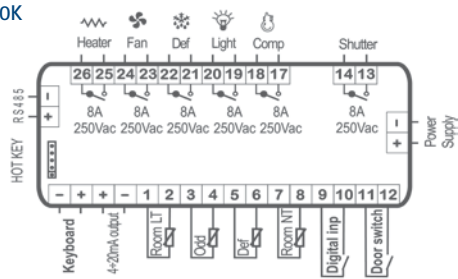

**T630**

6 key keyboard for controllers in K format

**Display: n° digits** ± 3 d.p.

**Keyboard: push buttons:** 6

**Slave module:** XW360K – XW370K

**Buzzer:** opt

The power modules in K format are available in different versions:

**OS:** open board

**GS:** standard case





## FAN SPEED CONTROLLERS

### SECTION INDEX

FUNCTIONS	MODELS	
<b>XV - single-phase fan speed management</b>		<b>144</b>
Single-phase speed controllers	XV05PD - XV05PK - XV10PK - XV22PK	145
Single-phase speed advanced controllers	XV105D - XV110K - XV150K	146



## XV SERIES: SINGLE-PHASE FAN SPEED CONTROLLERS

- Choked phase speed controllers to control pressure and temperature in refrigerating systems including cooling fans
- Inputs for regulation by temperature and pressure
- XM600 series compatible (4÷20mA/0÷10V or OC/PWM output) for anti-sweet heaters or evaporator fans applications
- Direct or inverse action for condenser or evaporator fans
- Cut off, minimum speed and max speed at start up functions
- Trigger output for managing another module
- 1VA max power absorption
- Measurement range: 0÷100%

### HOW TO ORDER

XV05PD X V 0 5 P D - 5 0 0 0 0

XV05/10/22PK X V P K - 5 0 0 0 0

XV100 X V 1 - 5 B C D 0

B	C	D
<b>Format</b>	<b>Type of action</b>	<b>Regulation input</b>
<b>0</b> = DIN <b>5</b> = Enclosure IP55	<b>D</b> = Direct + Cut Off <b>R</b> = Inverse + Cut Off	<b>N</b> = NTC probe <b>A</b> = Current (4÷20mA) <b>V</b> = 0÷1V/0÷10V



# XV100

## SINGLE-PHASE SPEED CONTROLLERS



PD: 4 DIN Rail



PK: 73x70mm

**XV05PD**  
**XV05PK**

Speed controllers designed for single-phase A.C. motors up to 500W, 2A, PWM input

**XV10PK**

Speed controller designed for single-phase A.C. motors up to 1000W, 4A, PWM input

**XV22PK**

Speed controller designed for single-phase A.C. motors up to 2200W, 9,5A, PWM input

FEATURES	XV05PD	XV05PK	XV10PK	XV22PK
Power supply	230Vac	230Vac	230Vac	230Vac
Control input	PWM from XV100, XM600	PWM from XV100, XM600	PWM from XV100, XM600	PWM from XV100, XM600
Direct-inverse function				
Full speed input at start up				
Trigger signal	pres	pres	pres	pres
Minimum speed function				
Cut off function				

XV05PD

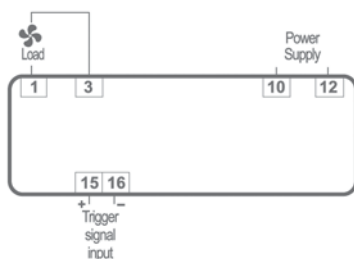

XV05PK  
XV10PK  
XV22PK

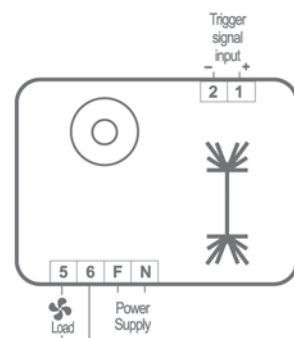

# XV100

## SINGLE-PHASE SPEED ADVANCED CONTROLLERS



D: 4 DIN Rail

K: 139x158mm

K: 176x200mm

**XV105D**

Speed controller designed for single-phase A.C. motors up to 500W, with input for NTC, 4÷20mA, 0÷1V or 0÷10V

**XV110K**

Speed controller designed for single-phase A.C. motors up to 1kW, with input for NTC, 4÷20mA, 0÷1V or 0÷10V

**XV150K**

Speed controller designed for single-phase A.C. motors up to 5kW, with input for NTC, 4÷20mA, 0÷1V or 0÷10V

FEATURES	XV105D	XV110K	XV150K
Power supply	230Vac	230Vac	230Vac
Control input	NTC 4÷20mA 0÷1V/0÷10V	NTC 4÷20mA 0÷1V/0÷10V	NTC 4÷20mA 0÷1V/0÷10V
Direct-inverse function	pres	pres	pres
Full speed input at start up	pres	pres	pres
Trigger signal	pres	pres	pres
Minimum speed function	pres	pres	pres
Cut off function	pres	pres	pres

XV150D

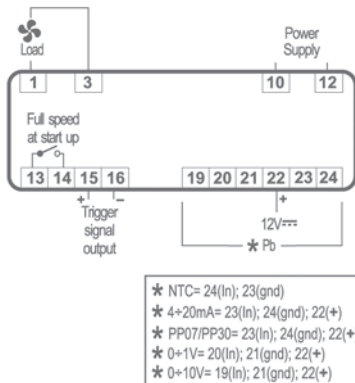

XV110K  
XV150K

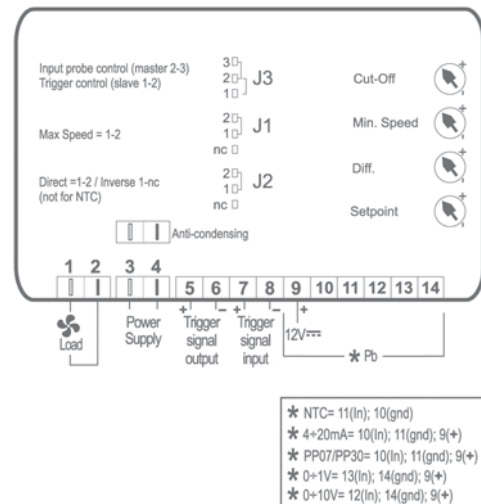

## ACCESSORY

**XV-ACK:** anti-condensing kit for XV110K and XV150K models

Resistance at 25°C (77°F): 100÷6000hm

Rated operating voltage: 120Vac or 220Vac

Max. operating voltage: 260Vac

Steady state current at 25°C (77°F): : 12A±30% (120Vac) 9A±30% (220Vac)





## TIME/TEMPERATURE/HUMIDITY/PRESSURE CONTROLLERS

### SECTION INDEX

FUNCTIONS	MODELS	
<b>XT100</b> - NTC, PTC, Pt100, TcJ, TcK, TcS, 4÷20mA, 0÷1V, 0÷10V multi-probe input – serial output		<b>148</b>
Digital indicator	XA100C	149
1 stage digital controllers	XT110C - XT110D - XT111C - XT111D - XT111R	149
2 stage digital controllers	XT120C - XT120D - XT121C - XT121D - XT121R	150
Neutral zone digital controllers	XT130C - XT130D - XT131C - XT131D - XT131R	151
2 stage PID digital controllers	XT141C - XT141D - XT141R	152
4 stage digital controllers	XT151D - XT160R	152
<b>XT200</b> - NTC, PTC, Pt100, TcJ, TcK, TcS, multi-probe input with time/temperature cycles – serial output		<b>153</b>
1 stage digital controllers with single display	XT210C - XT211C	154
2 stage digital controllers with single display	XT220C - XT221C	154
<b>XT400</b> - time/temperature cycle management – serial output		<b>155</b>
Timed cycle digital controller with dual display	XT420C	156
<b>XF</b> - cooking oven applications		<b>157</b>
Cooking oven digital controllers	XF320M - XF330M - XF331M - XF332M	158



R: 72x72mm



C: 32x74mm



D: 4 DIN Rail

## XT100 SERIES: NTC, PTC, Pt100, TcJ, TcK, TcS, 4÷20mA, 0÷1V, 0÷10V MULTI-PROBE CONTROLLERS – SERIAL OUTPUT

- Universal controllers to manage temperature, humidity and pressure in both the industrial and commercial applications
- Stock optimization: thanks to the multi-probe inputs
- 1 or 2 stage ON/OFF or PID with direct or reverse action
- Temperature inputs: PTC, NTC, Pt100; thermocouple J, K or S by selecting the parameters
- Pressure or humidity inputs: 4÷20mA, 0÷1V or 0÷10V by selecting the parameters
- Direct line power supply. No external transformer required
- Display with integrated measurement unit (°C / °F / RH / bar / PSI)
- Standard communication protocol ModBUS-RTU
- Hot key or Prog tool kit connector for a quick and easy programming
- 3VA max power absorption
- Display with red LED (10,5 mm high) and 5 icons

### HOW TO ORDER

XA100 [X][A][1][0][0][C][-][A][B][0][D][U]

XT100 [X][T][1][ ][ ][ ][-][A][B][C][D][U]



For blue display please contact Dixell

A	B	C	D
<b>Power supply</b>	<b>Measurement unit</b>	<b>Buzzer</b>	<b>SSR</b>
0 = 12Vac/dc 1 = 24Vac/dc 2 = 24Vac 4 = 110Vac 5 = 230Vac	C = °C F = °F B = Bar P = PSI H = %RH N = No unit of measurement	0 No 1 Yes 2 No 3 Yes	No No Yes Yes  SSR = 4÷20mA for D and R formats
			<b>Input</b>
			P = PTC (NTC) T = PTC (NTC, Pt100, TcJ, TcK, TcS) A = 4÷20mA, 0÷1V, 0÷10V B = PP07 (-0.5÷7bar) C = PP30 (0÷30bar) D = PP11 (-0.5÷11bar) H = XH10/20P

# XT100

## INDICATOR and 1 STAGE DIGITAL CONTROLLERS



C: 32x74mm

D: 4 DIN Rail

R: 72x72mm

<b>XA100C</b>	Configurable digital indicator
<b>XT110C XT110D</b>	ON/OFF configurable digital 1 stage controllers
<b>XT111C XT111D XT111R</b>	ON/OFF configurable digital 1 stage controllers with alarm relay

FEATURES	XA100C	XT110C	XT110D	XT111C	XT111D	XT111R
<b>Display: n° digits</b>	± 3½ d.p.	± 3½ d.p.	± 3½ d.p.	± 3½ d.p.	± 3½ d.p.	± 3½ d.p.
<b>Power supply</b>	12, 24Vac/dc 110, 230Vac	12, 24Vac/dc 110, 230Vac	24Vac/dc 24, 110, 230Vac	12, 24Vac/dc 110, 230Vac	24Vac/dc 24, 110, 230Vac	24Vac/dc 24, 110, 230Vac
<b>Probe inputs</b>						
NTC, PTC, Pt100, TcJ, TcK, TcS, 4÷20mA, 0÷1V, 0÷10V	config	config	config	config	config	config
<b>Relay outputs</b>						
Stage 1		8A	no 8A / nc 5A	8A	no 8A / nc 5A	8A
Stage 2						
Stage 3						
Stage 4						
Alarm				8A	no 8A / nc 5A	8A
<b>Other</b>						
Digital input	pres	pres	pres	pres	pres	pres
Hot Key/Prog Tool Kit output	pres	pres*	pres	pres*	pres	pres
Serial output	TTL	TTL*	TTL	TTL*	TTL	TTL
Analog output			4÷20mA opt		4÷20mA opt	4÷20mA opt
Buzzer	opt	opt	opt	opt	opt	opt

\*: Prog Tool Kit output and serial output only for models with 12/24Vac/dc probe supply

### XA100C

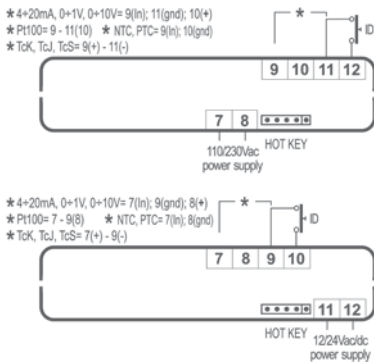

### XT110C

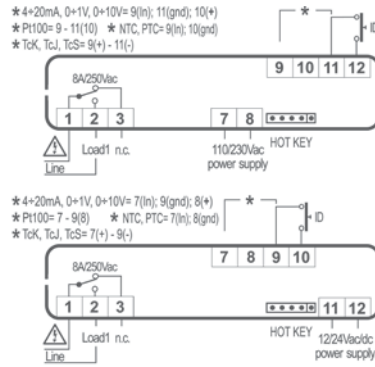

### XT110D

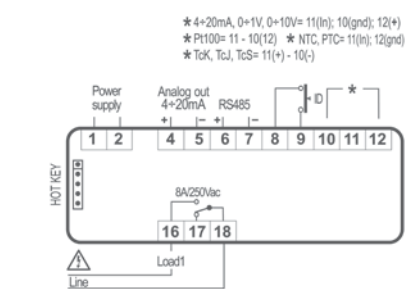

### XT111C

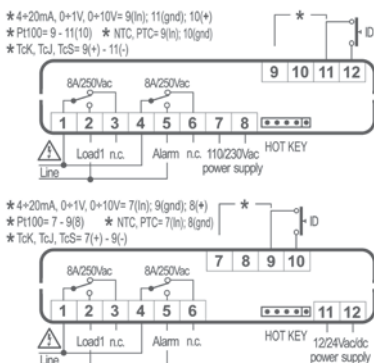

### XT111D

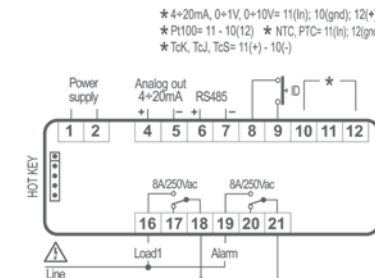

### XT111R

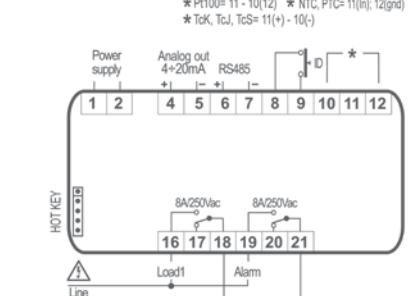

# XT100

## 2 STAGE DIGITAL CONTROLLERS



XT120C  
XT120D

ON/OFF configurable digital 2 stage controllers

XT121C  
XT121D  
XT121R

ON/OFF configurable digital 2 stage controllers with alarm relay

FEATURES	XT120C	XT120D	XT121C	XT121D	XT121R
<b>Display: n° digits</b>	± 3½ d.p.	± 3½ d.p.	± 3½ d.p.	± 3½ d.p.	± 3½ d.p.
<b>Power supply</b>	12, 24Vac/dc 110, 230Vac	24Vac/dc 24, 110, 230Vac	12, 24Vac/dc 110, 230Vac	24Vac/dc 24, 110, 230Vac	24Vac/dc 24, 110, 230Vac
<b>Probe inputs</b>					
NTC, PTC, Pt100, TcJ, TcK, TcS, 4÷20mA, 0÷1V, 0÷10V	config	config	config	config	config
<b>Relay outputs</b>					
Stage 1	8A	no 8A / nc 5A	8A	no 8A / nc 5A	8A
Stage 2	8A	no 8A / nc 5A	8A	no 8A / nc 5A	8A
Stage 3					
Stage 4					
Alarm			8A	no 8A / nc 5A	8A
<b>Other</b>					
Digital input	pres	pres	pres	pres	pres
Hot Key/Prog Tool Kit output	pres*	pres	pres*	pres	pres
Serial output	TTL*	TTL	TTL*	TTL	TTL
Analog output		4÷20mA opt		4÷20mA opt	4÷20mA opt
Buzzer	opt	opt	opt	opt	opt

\*: Prog Tool Kit output and serial output only for models with 12/24Vac/dc probe supply

### XT120C

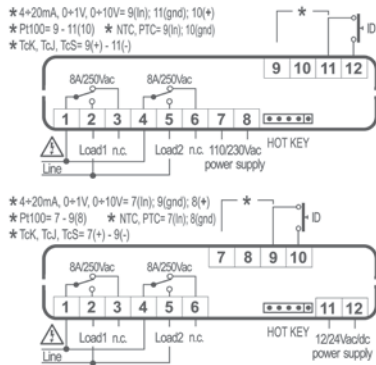

### XT120D

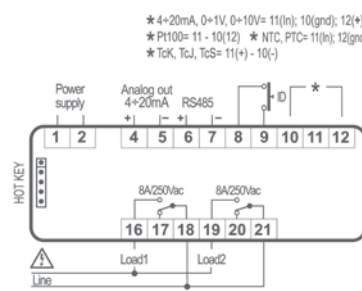

### XT121C

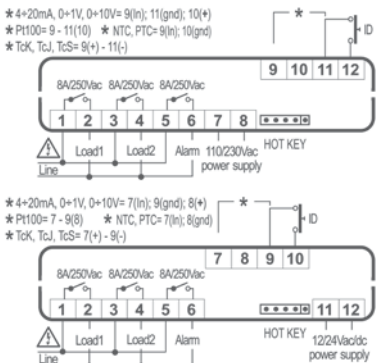

### XT121D

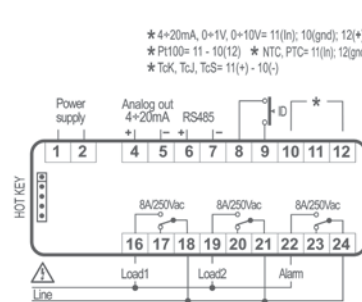

### XT121R

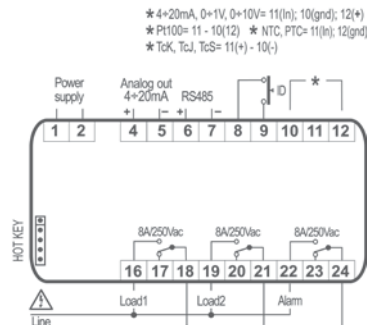

# XT100

## NEUTRAL ZONE DIGITAL CONTROLLERS



XT130C  
XT130D

ON/OFF configurable digital neutral zone controllers

XT131C  
XT131D  
XT131R

ON/OFF configurable digital neutral zone controllers with alarm relay

FEATURES	XT130C	XT130D	XT131C	XT131D	XT131R
<b>Display: n° digits</b>	± 3½ d.p.	± 3½ d.p.	± 3½ d.p.	± 3½ d.p.	± 3½ d.p.
<b>Power supply</b>	12, 24Vac/dc 110, 230Vac	24Vac/dc 24, 110, 230Vac	12, 24Vac/dc 110, 230Vac	24Vac/dc 24, 110, 230Vac	24Vac/dc 24, 110, 230Vac
<b>Probe inputs</b>	config	config	config	config	config
<b>Relay outputs</b>					
Stage 1	8A	no 8A / nc 5A	8A	no 8A / nc 5A	8A
Stage 2	8A	no 8A / nc 5A	8A	no 8A / nc 5A	8A
Stage 3					
Stage 4					
Alarm			8A	no 8A / nc 5A	8A
<b>Other</b>					
Digital input	pres	pres	pres	pres	pres
Hot Key/Prog Tool Kit output	pres*	pres	pres*	pres	pres
Serial output	TTL*	TTL	TTL*	TTL	TTL
Analog output		4÷20mA opt		4÷20mA opt	4÷20mA opt
Buzzer	opt	opt	opt	opt	opt

\*: Prog Tool Kit output and serial output only for models with 12/24Vac/dc probe supply

### XT130C

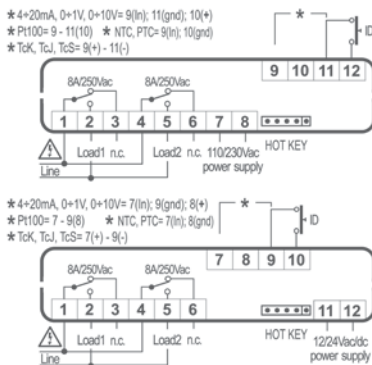

### XT130D

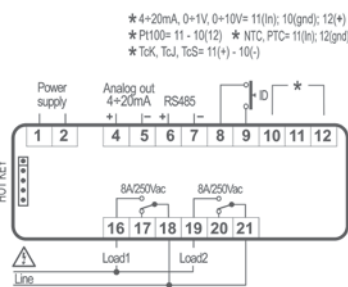

### XT131C

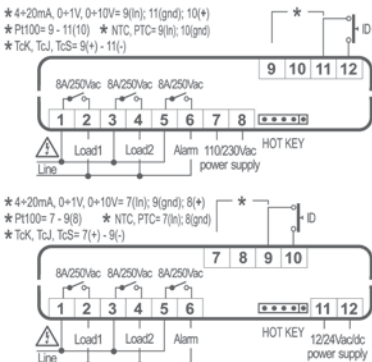

### XT131D

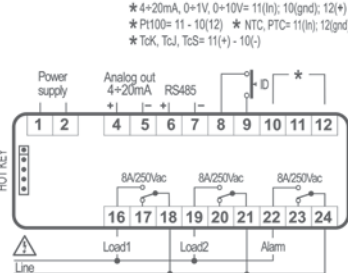

### XT131R

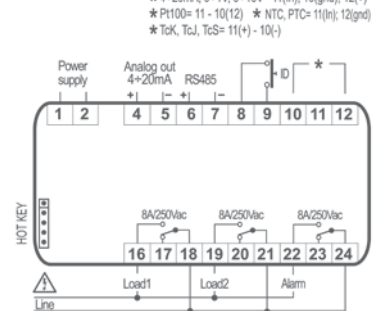

# XT100

## 2 STAGE PID and 4 STAGE DIGITAL CONTROLLERS



C: 32x74mm

D: 4 DIN Rail

R: 72x72mm

XT141C  
XT141D  
XT141R

PID configurable digital 2 stage controllers with alarm relay

XT151D

ON/OFF configurable digital 3 stage controller with alarm relay

XT160D

ON/OFF configurable digital 4 stage controller

FEATURES	XT141C	XT141D	XT141R	XT151D	XT160D
<b>Display: n° digits</b>	± 3½ d.p.	± 3½ d.p.	± 3½ d.p.	± 3½ d.p.	± 3½ d.p.
<b>Power supply</b>	12, 24Vac/dc 110, 230Vac	24Vac/dc 24, 110, 230Vac	24Vac/dc 24, 110, 230Vac	24Vac/dc 24, 110, 230Vac	24Vac/dc 24, 110, 230Vac
<b>Probe inputs</b>					
NTC, PTC, Pt100, TcJ, TcK, TcS, 4÷20mA, 0÷1V, 0÷10V	config	config	config	config	config
<b>Relay outputs</b>					
Stage 1	8A	no 8A / nc 5A	8A	no 8A / nc 5A	no 8A / nc 5A
Stage 2	8A	no 8A / nc 5A	8A	no 8A / nc 5A	no 8A / nc 5A
Stage 3				no 8A / nc 5A	no 8A / nc 5A
Stage 4					8A
Alarm	8A	no 8A / nc 5A	8A	8A	
<b>Other</b>					
Digital input	pres	pres	pres	pres	pres
Hot Key/Prog Tool Kit output	pres*	pres	pres	pres	pres
Serial output	TTL*	TTL	TTL	TTL	TTL
Analog output		4÷20mA opt	4÷20mA opt	4÷20mA opt	4÷20mA opt
Buzzer	opt	opt	opt	opt	opt

\*: Prog Tool Kit output and serial output only for models with 12/24Vac/dc probe supply

### XT141C

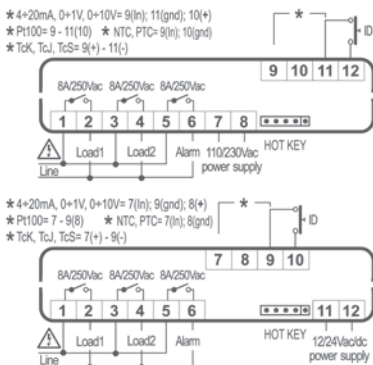

### XT141D

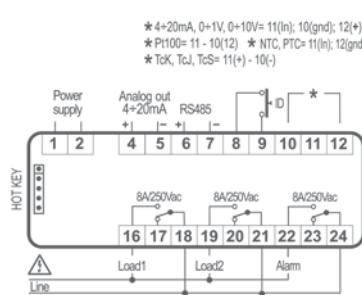

### XT141R

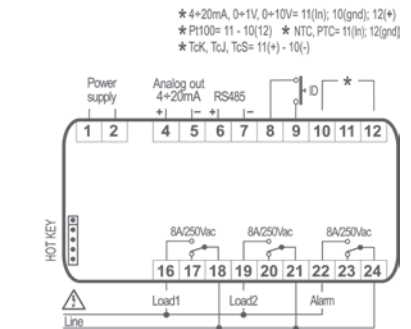

### XT151D

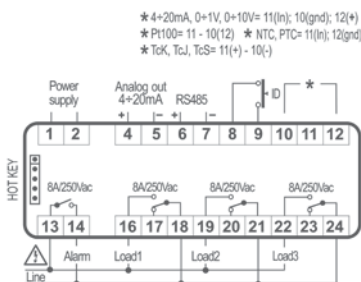

### XT160D

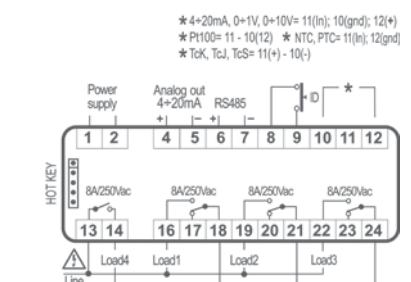





C: 32x74mm

STANDARD DISPLAY: TEMPERATURE

temperature



DISPLAY DURING A CYCLE: COUNT DOWN TIME

h / min

min / sec



## XT200 SERIES: NTC, PTC, Pt100, TcJ, TcK, TcS, MULTI-PROBE CONTROLLERS WITH TIME/TEMPERATURE CYCLES – SERIAL OUTPUT

- Controllers with temperature management by timed cycles
- Stock optimization: thanks to the multi-probe inputs
- 1 or 2 stage ON/OFF with direct or reverse action
- Temperature inputs: PTC, NTC, Pt100; thermocouple J, K or S by selecting the parameters
- Direct line power supply. No external transformer required
- Display with integrated measurement unit (°C/°F)
- Standard communication protocol ModBUS-RTU
- Hot key or Prog tool kit connector for a quick and easy programming
- Max cycle duration: 19h - 59min
- 3VA max power absorption
- Display with red LED (10,5 mm high) and 5 icons

### HOW TO ORDER

XT200 

X	T	2			C	-	A	B	C	T	E
---	---	---	--	--	---	---	---	---	---	---	---



For blue display please contact Dixell

A	B	C			E
<b>Power supply</b>	<b>Measurement unit</b>		<b>Buzzer</b>	<b>SSR</b>	<b>Time</b>
0 = 12Vac/dc 1 = 24Vac/dc 4 = 110Vac 5 = 230Vac	C = °C F = °F	0 No 1 Yes 2 No 3 Yes	No No Yes Yes	No No Yes Yes	0 = h / min 1 = min / sec

# XT200

## 1 or 2 STAGE DIGITAL CONTROLLERS with SINGLE DISPLAY



C: 32x74mm

<b>XT210C</b>	ON/OFF configurable digital 1 stage controller
<b>XT211C</b>	ON/OFF configurable digital 1 stage controller with alarm relay
<b>XT220C</b>	ON/OFF configurable digital 2 stage controller
<b>XT221C</b>	ON/OFF configurable digital 2 stage controller with alarm relay

FEATURES	XT210C	XT211C	XT220C	XT221C
<b>Display: n° digits</b>	± 3½ d.p.	± 3½ d.p.	± 3½ d.p.	± 3½ d.p.
<b>Power supply</b>	12, 24Vac/dc 110, 230Vac	12, 24Vac/dc 110, 230Vac	12, 24Vac/dc 110, 230Vac	12, 24Vac/dc 110, 230Vac
<b>Probe inputs</b>				
NTC, PTC, Pt100, TcJ, TcK, TcS	config	config	config	config
<b>Relay outputs</b>				
Stage 1	8A	8A	8A	8A
Stage 2			8A	8A
Alarm		8A		8A
<b>Other</b>				
Digital input	pres	pres	pres	pres
Hot Key/Prog Tool Kit output	pres	pres	pres	pres
Serial output	TTL	TTL	TTL	TTL
Buzzer	opt	opt	opt	opt

### XT210C

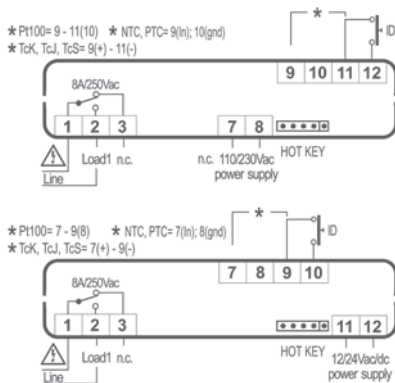

### XT211C

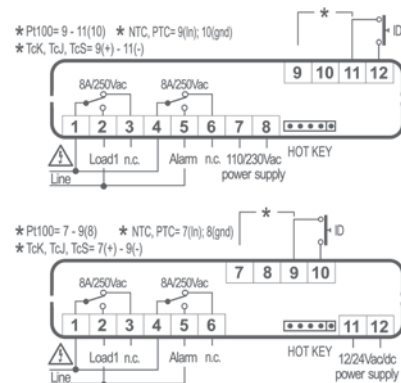

### XT220C

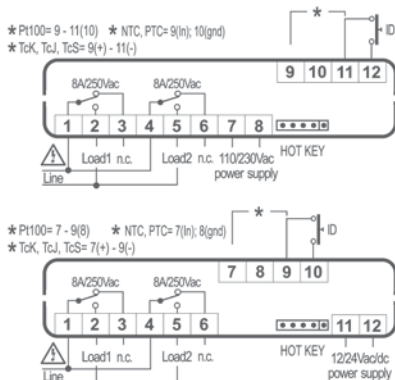

### XT221C

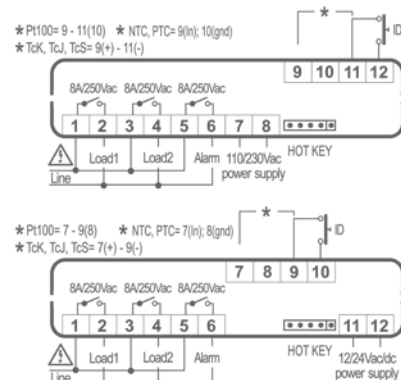



C: 32x74mm



## XT400 SERIES: CONTROLLERS WITH TIME/TEMPERATURE CYCLE MANAGEMENT – SERIAL OUTPUT

- Controllers with timed cycles for oven applications and cooking cycles
- Simultaneous display of temperature (upper display) and count down time (lower display)
- Door switch facility
- End cycle signalling
- Instant visibility of machine status via display icons
- Standard communication protocol ModBUS-RTU
- Hot key or Prog tool kit connector for a quick and easy programming
- 5VA max power absorption
- Dual display with red LED (8,0mm high) and yellow LED (5,6mm high) and 13 icons

### HOW TO ORDER

XT400 X T 4 2 0 C - A B C D E



For blue display please contact Dixell

A	B	C	D	E
<b>Power supply</b>	<b>Measurement unit</b>	<b>Buzzer</b>	<b>Type of probe</b>	<b>RTC</b>
1 = 24Vac 4 = 110Vac 5 = 230Vac	C = °C F = °F	0 = No 1 = Yes	N = NTC P = PTC	0 = No 1 = Yes

# XT400

## TIMED CYCLE DIGITAL CONTROLLER with DUAL DISPLAY



C: 32x74mm

XT420C

ON/OFF configurable digital 1 stage controllers with timed cycle management

### FEATURES

### XT420C

First display: n° digits	± 3 d.p.
Second display: n° digits	± 4 d.p.
Power supply	24, 110, 230Vac
<b>Probe inputs</b>	
Thermostat	NTC/PTC
<b>Digital inputs</b>	
Safety, start defrost, door switch	config
<b>Relay outputs</b>	
Load	8A
Light	8A
<b>Other</b>	
Hot Key/Prog Tool Kit output	pres
Serial output	TTL
Buzzer	opt
Real time clock	opt

XT420C

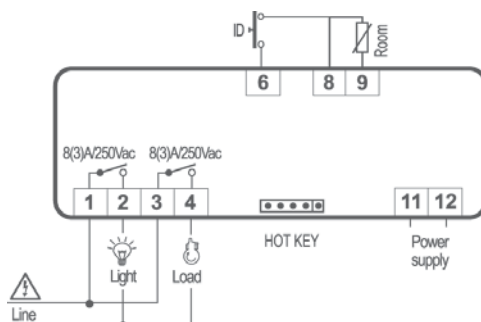



M: 144x72mm



M: 144x72mm

oven temperature



percentage of top/bottom power



hour/cooking cycles



ceiling temperature



bottom temperature



hour/cooking cycles



## XF SERIES: CONTROLLERS FOR COOKING OVEN APPLICATIONS

- Up to 9 programmable cooking cycles
- Start of cooking cycle settable by real time clock
- "Economy" function for energy saving
- Pt100 or TCJ/TCK probes selectable by user
- Management of the steam injection: automatic or manual mode
- Custom versions on request
- Hot key connector for a quick and easy programming
- 5VA max power absorption
- Display with red LED 13,2mm (n° 2), 10,5mm (timer)



To set the target set point (ceiling and bottom)



To set cooking time



To start and stop the cooking cycles



To set cooking cycle start



To set the daily repetition of the cooking cycle



To set cooking programs



To start and stop the steam extractor



To start and stop the steam generator



Enable the steam injection



To start and stop the energy saving function



To switch the light



On/off button

### HOW TO ORDER

XF       -

A	B	C	D	E
<b>Power supply</b>	<b>Inputs</b>	<b>Buzzer</b>	<b>Measurement unit</b>	<b>Outputs for SSR</b>
2 = 24Vac 4 = 110Vac 5 = 230Vac	P = Pt100 J = J thermocouple K = K thermocouple	0 = No 1 = Yes	C = °C F = °F	0 = Standard outputs 1 = 12V-20mA for SSR

# XF

## COOKING OVEN DIGITAL CONTROLLERS



M: 144x72mm

**XF320M**

Digital controller for cooking ovens with separated ceiling and bottom power regulation, with steam injection and internal RTC for starting and cooking time management

**XF330M**

Digital controller for cooking ovens with separated ceiling and bottom temperature regulation, with steam injection and internal RTC for starting and cooking time management, auxiliary ON/OFF relay

FEATURES	XF320M	XF330M
<b>Temperature display: n° digits</b>	n° 1 x 3	n° 2 x 3
<b>Clock display: n° digits</b>	4	4
<b>Power % indicator</b>	bargraph	
<b>Power supply</b>	24, 110, 230Vac	24, 110, 230Vac
<b>Probe inputs</b>		
Zone	Pt100/TCJ/TCK	
Ceiling		Pt100/TCJ/TCK
Bottom		Pt100/TCJ/TCK
Steam	Pt100/TCJ/TCK	
<b>Relay outputs</b>		
Ceiling	8A	8A
Bottom	8A	8A
Fans		
ON/OFF		8A
Light	8A	8A
Steam generator	12A	12A
Steam injection	8A	8A
Steam extractor	8A	8A
<b>Other</b>		
Digital input		
Hot Key output	pres	pres
Buzzer	opt	opt

XF320M

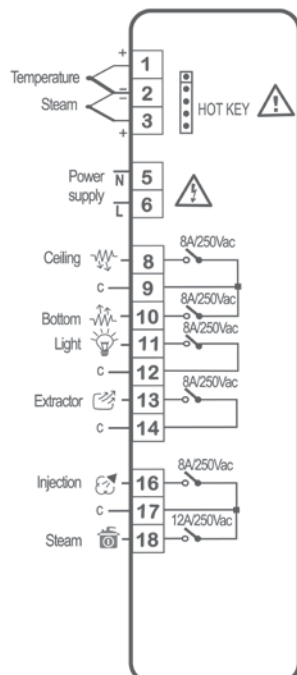

XF330M

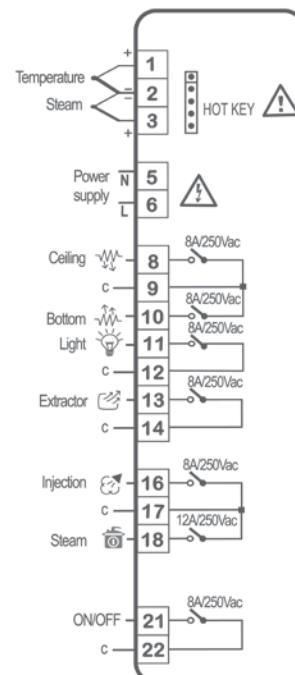

# XF

## COOKING OVEN DIGITAL CONTROLLERS



M: 144x72mm

**XF331M**

Digital controller for cooking ovens with separated ceiling and bottom temperature regulation, with steam injection and internal RTC for starting and cooking time management

**XF332M**

Digital controller for cooking ovens with separated ceiling and bottom temperature regulation, with steam injection, fans management and internal RTC for starting and cooking time management

FEATURES	XF331M	XF332M
<b>Temperature display: n° digits</b>	n° 2 x 3	n° 2 x 3
<b>Clock display: n° digits</b>	4	4
<b>Power % indicator</b>		
<b>Power supply</b>	24, 110, 230Vac	24, 110, 230Vac
<b>Probe inputs</b>		
Zone		
Ceiling	Pt100/TCJ/TCK	Pt100/TCJ/TCK
Bottom	Pt100/TCJ/TCK	Pt100/TCJ/TCK
Steam		
<b>Relay outputs</b>		
Ceiling	8A	8A
Bottom	8A	8A
Fans		12A
ON/OFF	8A	
Light	8A	8A
Steam generator	12A	
Steam injection	8A	8A
Steam extractor		8A
<b>Other</b>		
Digital input	pres	
Hot Key output	pres	pres
Buzzer	opt	opt

XF331M

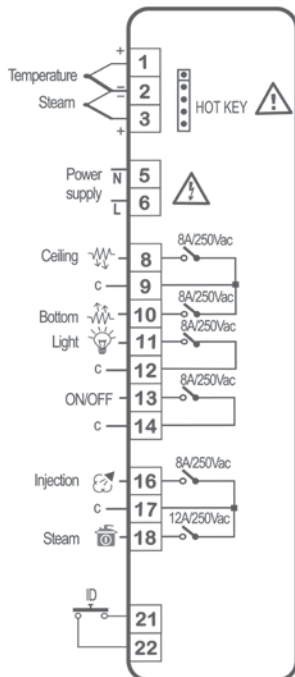

XF332M

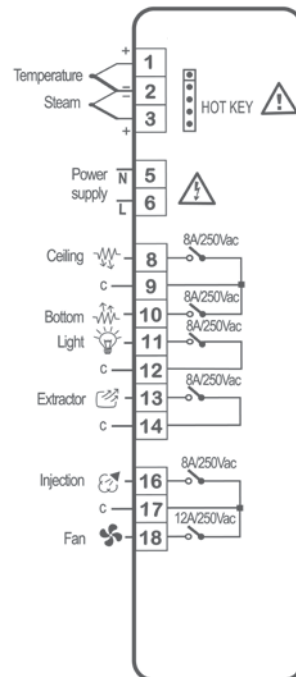



## PROBES & ACCESSORIES

A complete series of probes and transducers for temperature, humidity and pressure ensures the final user to have a range of useful accessories for easy, fast and accurate use of each instrument in every application.







# PROBES

## SECTION INDEX

FUNCTIONS	MODELS	
<b>TEMPERATURE PROBES</b>		
PTC probes	S6 - S6.R - S6.S - S6.SH - SA6 - ST6 - SC5.5	162
NTC probes	NS6 - NS6W - NS6S - NS6SJ - NS6SW - NG6 - NG6F NG6W - NG6P - NG6P - NX6K - NX6PJ - NY6P - NY6PJ NT6-55 - NT6-67 - NT6 - N6F2	163
PT1000 probes	PMG5P - PMP4-67 - PMT6-67	164
NTC/PT1000 product probes	NGPOP - PMGPOP	164
PTC/NTC insert probes	SPC10PS - NPC10PS - SPC10IS - NPC10IS - SPC10IA - NPC10IA	164
PT100 thermoresistors	PT6 - PT6.S - PT6.F - PT310 - PT315	164
TC thermocouples	TJ6 - TK6 - TJD215 - TJD320 - TKD215 - TKD320 - CMJ - CMK	165
<b>HUMIDITY PROBES</b>		
Humidity probes	XH10P - XH20P	165
<b>PRESSURE PROBES</b>		
Pressure transducers	PP07 - PP11 - PP30 - PP30FE	166
Ratiometric pressure transducers	PPR15 - PPR30	166









# PROBES

## TEMPERATURE PROBES







### PTC PROBES

The probes with PTC thermistor are designed for both cooling and heating applications. The temperature range is  $-50 \div 150^{\circ}\text{C}$  ( $-58 \div 230^{\circ}\text{F}$ ).

PROBE	DESCRIPTION	CABLE	TEMP. RANGE	
S6	General purpose, resinated, IP67, inox steel cap "dimension $\text{\O}6 \times 30\text{mm}$ "	PVC - 1,5/2,0m	$-30 \div 80^{\circ}\text{C}$ $-22 \div 176^{\circ}\text{F}$	
S6.R	Water proof, resinated, IP67, inox steel cap "dimension $\text{\O}6 \times 40\text{mm}$ "	PVC - 1,5/2,0m	$-30 \div 80^{\circ}\text{C}$ $-22 \div 176^{\circ}\text{F}$	
S6.S	Water proof, resinated, inox steel cap "dimension $\text{\O}6 \times 40\text{mm}$ "	Silicone - 1,5/2,0m	$-50 \div 120^{\circ}\text{C}$ $-58 \div 248^{\circ}\text{F}$	
S6.SH	Heating applications, inox steel cap "dimension $\text{\O}6 \times 40\text{mm}$ "	Silicone - 1,5/2,0m	$-50 \div 150^{\circ}\text{C}$ $-58 \div 302^{\circ}\text{F}$	
SA6	Perforated for air, inox steel cap "dimension $\text{\O}6 \times 30\text{mm}$ "	PVC - 1,5/2,0m	$0 \div 80^{\circ}\text{C}$ $32 \div 176^{\circ}\text{F}$	
ST6	Pipemount fitting	PVC - 1,5/2,0m	$0 \div 80^{\circ}\text{C}$ $32 \div 176^{\circ}\text{F}$	
SC5.5	Probe fixed with threaded male, inox steel cap "dimension $\text{\O}6 \times 80\text{mm}$ "	PVC - 2,0m	$-30 \div 80^{\circ}\text{C}$ $-22 \div 176^{\circ}\text{F}$	

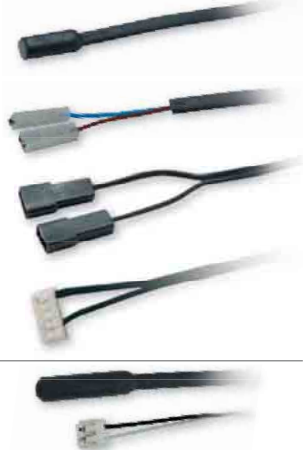

## NTC PROBES

The probes with NTC thermistor are designed for applications where high accuracy and the short response time is important. The probe passes several tests, this is why we guarantee a very high reliability.

PROBE	DESCRIPTION	CABLE	TEMP. RANGE	
NS6	General purpose, resinated, IP67, inox steel cap "dimension Ø6x30mm"	PVC - 1,5/3,0m	-30÷80°C -22÷176°F	
NS6W	General purpose, resinated, IP67, with 6,3mm faston, inox steel cap "dimension Ø6x30mm", for WING split	PVC - 1,5m	-30÷80°C -22÷176°F	
NS6S	General purpose, resinated, IP67, inox steel cap "dimension Ø6x30mm"	Silicone - 1,5	-40÷110°C -40÷230°F	
NS6SJ	General purpose, resinated, IP67, 2 pole connector, inox steel cap "dimension Ø6x30mm"	Silicone - 1,5/3,0m	-40÷110°C -40÷230°F	
NS6SW	General purpose, resinated, IP67, with 6,3mm faston, inox steel cap "dimension Ø6x30mm", for WING split	Silicone - 1,5m	-40÷110°C -40÷230°F	
NG6	General purpose, over-molded, IP67, thermoplastic cap "dimension Ø6x15mm"	Thermoplastic 1,5/3,0m	-40÷110°C -40÷230°F	
NG6F	General purpose, over-molded, IP67, with 2,8mm faston, thermoplastic cap "dimension Ø6x15mm", for XT11S 12Vac, 24Vac/dc	Thermoplastic 1,5/2,0m	-40÷110°C -40÷230°F	
NG6W	General purpose, over-molded, IP67, with 6,3mm faston, thermoplastic cap "dimension Ø6x15mm", for WING split	Thermoplastic 1,5/3,0m	-40÷110°C -40÷230°F	
NG6K	General purpose, over-molded, IP68, Hot Key connector, thermoplastic cap "dimension Ø6x15mm"	Thermoplastic 1,5m	-40÷110°C -40÷230°F	
NG6P	General purpose, over-molded, IP68, thermoplastic cap "dimension Ø5x20mm"	Thermoplastic 1,5/3,0m	-40÷110°C -40÷230°F	
NX6P	Thermoplastic, IP68, inox steel cap "dimension Ø6x20mm"	Thermoplastic 1,5/3,0m	-40÷110°C -40÷230°F	
NX6PJ	Thermoplastic, IP68, 2 pole connector, inox steel cap "dimension Ø6x20mm"	Thermoplastic 1,5/3,0m	-40÷110°C -40÷230°F	
NY6P	Thermoplastic, IP68, inox steel cap "dimension Ø6x50mm"	Thermoplastic 1,5/3,0m	-40÷110°C -40÷230°F	
NY6PJ	Thermoplastic, IP68, 2 pole connector, inox steel cap "dimension Ø6x50mm"	Thermoplastic 1,5/3,0m	-40÷110°C -40÷230°F	
NT6-55	Pipemount fitting "Ø4÷Ø30mm in diameter", IP55, over-molded, copper sensor	Thermoplastic 1,5m	-40÷110°C -40÷230°F	
NT6-67	Pipemount fitting "Ø4÷Ø30mm in diameter", IP67, over-molded, thermoplastic sensor	Thermoplastic 1,5m	-40÷110°C -40÷230°F	
NT6	Pipemount fitting	PVC - 1,5/2,0m	0÷80°C 32÷176°F	
N6F2	General purpose, resinated, IP67, with 2,8mm faston, double insulation, nylon cap "dimension Ø7x30mm", for XT11S 230Vac	PVC - 1,5/2,0m	-30÷105°C -22÷221°F	

## PT1000 PROBES

PT1000 probes are suitable for all applications where the temperature is between  $-50\div 120^{\circ}\text{C}$  ( $-58\div 248^{\circ}\text{F}$ ) and it is important to maintain precision over long distances.

PROBE	DESCRIPTION	CABLE	TEMP. RANGE	
PMG5P	Thermoplastic wire, IP68, cap dimension $\varnothing 5 \times 20\text{mm}$	Thermoplastic 1,5 $\div$ 3,0m	$-50\div 110^{\circ}\text{C}$ $-58\div 230^{\circ}\text{F}$	
PMP4-67	Pipemount fitting $\varnothing 4\div\varnothing 30\text{mm}$ in diameter, IP67, over-molded	Thermoplastic 1,5 $\div$ 3,0m	$-50\div 110^{\circ}\text{C}$ $-58\div 230^{\circ}\text{F}$	
PMT6-67	Pipemount fitting $\varnothing 4\div\varnothing 30\text{mm}$ in diameter, IP67, over-molded	Thermoplastic 1,5 $\div$ 3,0m	$-50\div 120^{\circ}\text{C}$ $-58\div 248^{\circ}\text{F}$	



## PRODUCT PROBE

The product probes with NTC or PT1000 sensor allow to simulate and display the temperature of the goods and manage alarms according to the temperature near the product and not the air around it. Thanks to the magnets, these probes are particularly suitable for use on shelves.

PROBE	DESCRIPTION	CABLE	TEMP. RANGE	
NGPOP	NTC sensor, thermoplastic, IP68, 100x100mm	Thermoplastic - 5m	$-40\div 110^{\circ}\text{C}$ $-40\div 230^{\circ}\text{C}$	
PMGPOP	PT1000 sensor, thermoplastic, IP68, 100x100mm	Thermoplastic - 5m	$-50\div 120^{\circ}\text{C}$ $-58\div 248^{\circ}\text{C}$	





## PTC/NTC INSERT PROBES

The insert probes with PTC or NTC sensor are suitable for applications where it is important to know the core temperature of goods. They generally are used together with cooking oven or blast chiller controllers.

PROBE	DESCRIPTION	CABLE	TEMP. RANGE	
SPC10PS	PTC sensor, plastic handle, inox steel cap "dimension $\varnothing 3,5 \times 100\text{mm}$ "	Silicone - 3m	$-38\div 80^{\circ}\text{C}$ $-36\div 176^{\circ}\text{F}$	
NPC10PS	NTC sensor, plastic handle, inox steel cap "dimension $\varnothing 3,5 \times 100\text{mm}$ "	Silicone - 3m	$-30\div 80^{\circ}\text{C}$ $-86\div 176^{\circ}\text{F}$	
SPC10IS	PTC sensor, plastic handle, inox steel cap "dimension $\varnothing 3,5 \times 100\text{mm}$ "	Silicone - 3m	$-50\div 120^{\circ}\text{C}$ $-58\div 248^{\circ}\text{F}$	
NPC10IS	NTC sensor, plastic handle, inox steel cap "dimension $\varnothing 3,5 \times 100\text{mm}$ "	Silicone - 3m	$-50\div 120^{\circ}\text{C}$ $-58\div 248^{\circ}\text{F}$	
SPC10IA	PTC sensor, plastic handle, inox steel cap "dimension $\varnothing 3,5 \times 100\text{mm}$ "	Silicone for use with food - 3m	$-50\div 120^{\circ}\text{C}$ $-58\div 248^{\circ}\text{F}$	
NPC10IA	NTC sensor, plastic handle, inox steel cap "dimension $\varnothing 3,5 \times 100\text{mm}$ "	Silicone for use with food - 3m	$-50\div 120^{\circ}\text{C}$ $-58\div 248^{\circ}\text{F}$	

## PT100 THERMORESISTORS

Thermoresistance (RTD) probes are suitable when a high precision and a low response time is necessary. The operating range of the PT100 sensor is from  $-70\div 500^{\circ}\text{C}$  ( $-94\div 932^{\circ}\text{F}$ ), the precision is according to standard IEC751.

PROBE	DESCRIPTION	CABLE	TEMP. RANGE	
PT6	General purpose, 3 wires, inox steel cap "dimension $\varnothing 6 \times 100\text{mm}$ "	PVC - 2m	$-30\div 105^{\circ}\text{C}$ $-22\div 221^{\circ}\text{F}$	
PT6.S	Protected, 3 wires, inox steel cap "dimension $\varnothing 6 \times 50\text{mm}$ "	Silicone - 2m	$-60\div 200^{\circ}\text{C}$ $-76\div 392^{\circ}\text{F}$	
PT6.F	Protected, 3 wires, inox steel cap "dimension $\varnothing 6 \times 100\text{mm}$ "	Vetrotex - 2m	$-60\div 350^{\circ}\text{C}$ $-76\div 662^{\circ}\text{F}$	
PT310	Compact, with male connection, 2 wires, inox steel cap "dimension $\varnothing 3 \times 100\text{mm}$ "	Silicone - 2m	$-70\div 500^{\circ}\text{C}$ $-94\div 932^{\circ}\text{F}$	
PT315	Compact, with male connection, 2 wires, inox steel cap "dimension $\varnothing 3 \times 150\text{mm}$ "	Silicone - 2m	$-70\div 500^{\circ}\text{C}$ $-94\div 932^{\circ}\text{F}$	

## TC THERMOCOUPLES

Thermocouple (TC) probes are suitable when a short response time and high shock resistance are necessary. The operating range of the TCJ sensor is from 0÷600°C (32÷1112°F) and the range of the TCK is from 0÷1150°C (32÷2102°F), the precision is according to standard IEC584-2.

PROBE	DESCRIPTION	TEMP. RANGE	
TJ6	General purpose, protected, Fe-CO, cap "dimension Ø6x100mm", 2,0/3,0m vetrotex cable	-30÷350°C -22÷662°F	
TK6	General purpose, protected, Cr-Al, cap "dimension Ø6x100mm", 2,0/3,0m vetrotex cable	0÷350°C 32÷662°F	
TJD215	DIN connector, Fe-CO, cap "dimension Ø2x150mm"	0÷600°C 32÷1112°F	
TJD320	DIN connector, Fe-CO, cap "dimension Ø3x200mm"	0÷600°C 32÷1112°F	
TKD215	DIN connector, Cr-Al, cap "dimension Ø2x150mm"	0÷1150°C 32÷2102°F	
TKD320	DIN connector, Cr-Al, cap "dimension Ø3x200mm"	0÷1150°C 32÷2102°F	
CMJ	Compensating female connector, Fe-CO, for TJD215 and TJD320	-40÷200°C -40÷392°F	
CMK	Compensating female connector, Cr-Al, for TKD215 and TKD320	-40÷200°C -40÷392°F	

## HUMIDITY PROBES

XH10P and XH20P humidity probes are suitable for all those applications where it is necessary to detect and control humidity. Such applications are: refrigeration, drying processes etc.

**Power consumption:** 22mA max

**Protection:** IP65

**Storage temperature:** -30÷85°C (22÷185°F)



## HOW TO ORDER

XH10/20  X  H    P  -  O  B  O  O  O

B

**Output**

0 = 4÷20mA  
1 = 0÷10Vdc

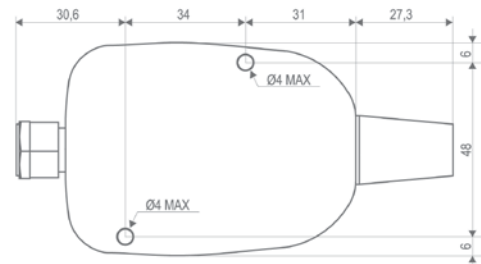

PROBE	POWER SUPPLY	ACCURACY	OUTPUT	OPERATING TEMPERATURE	MEASUREMENT RANGE
XH10P	9÷18Vac - 19÷35Vdc	±5%	4÷20mA	0÷60°C (32÷140°F)	30÷90% R.H.
	15÷35Vdc	±5%	0÷10Vdc	0÷60°C (32÷140°F)	30÷90% R.H.
XH20P	9÷18Vac - 19÷35Vdc	±3%	4÷20mA	0÷70°C (32÷158°F)	0÷99% R.H.
	15÷35Vdc	±3%	0÷10Vdc	0÷70°C (32÷158°F)	0÷99% R.H.

## PRESSURE PROBES

### PRESSURE TRANSDUCERS

Pressure transducer supply a standard output current signal (4÷20mA). The silicon sensor is assembled in a waterproof steel housing filled with oil that guarantees stable and constant measurement besides protection against vibrations and duration equivalent to millions of pressure cycles. The tip of the probe is made of 316L steel and this allows the probes to be placed in contact with ammonia and all kinds of corrosive gases in general.



PP07	2 wires transducer with 4÷20mA output and measurement range -0,5÷7bar
PP11	2 wires transducer with 4÷20mA output and measurement range -0,5÷11bar
PP30	2 wires transducer with 4÷20mA output and measurement range 0÷30bar
PP30FE	2 wires transducer with 4÷20mA output, female fitting and measurement range 0÷30bar

Power supply:	8÷28Vdc
Output:	4÷20mA
Protection:	IP65
Operating temperature:	-20÷80°C (-4÷176°F)
Storage temperature:	-35÷80°C (-31÷176°F)
Accuracy:	1% F.S.

PP07 - PP11 - PP30

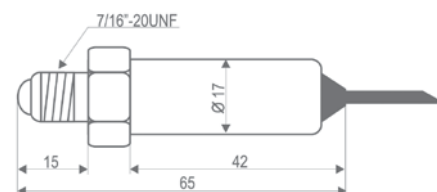

PP30FE

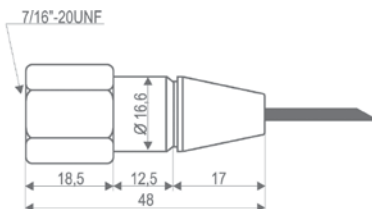

## RATIOMETRIC PRESSURE TRANSDUCERS

Pressure transducer supply a standard output ratiometric signal (0÷5V). The design is ideal for demanding HVAC and refrigeration applications where long term reliability is necessary. The electrical interface is a rugged industry accepted connector. This device maintains accuracy through a wide temperature range.



PPR15	3 wires ratiometric transducer with 0÷5V output and measurement range 0÷15bar
PPR30	3 wires ratiometric transducer with 0÷5V output and measurement range 0÷35bar

Power supply:	4,5÷5,5Vdc
Output:	0,5÷4,5Vdc
Measurement range:	PPR15 (0÷15bar) - PPR30 (0÷35bar)
Protection:	IP65
Operating temperature:	-40÷135°C (-40÷275°F)
Storage temperature:	-40÷135°C (-40÷275°F)
Accuracy:	1,2% F.S.

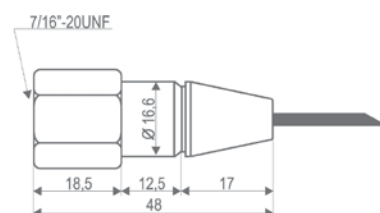



# ACCESSORIES



## SECTION INDEX

FUNCTIONS	MODELS	
<b>ACCESSORIES</b>		<b>168</b>
Modems and cables for systems and programmable controllers	XWEB MODEM - TC35-KIT - CAB/WEB/NET - CAB/WEB/PC	168
iCOOLL modules for wireless network	XJ100 - XJ150 - PWS150J	168
Programming keys	HOT KEY - HOT KEY 64 - HOT KEY 128 - VISOKEY	169
Programming keyboard	KB1-PRG - CAB/KB11	169
Programming tool	WIZ TOOL KIT	169
Serial interface	XJ485CX - XJRS485 - CAB/RS1 - CAB/RS2 CAB/RS3 - CAB/RS5	169
Remote display	X-REP - CAB/REP1 - CAB/REP3 - CAB/REP5 CAB51F - CAB52F - CAB55F	170
Connections	CAB/OS1 - CAB/OS2 - CAB/OS3 - CW15-KIT - CF-KIT CAB/CJ15 - CAB/CJ30 - LW30-KIT - DWA30-KIT DWB30-KIT - DWEX60-30KIT - DWXEV30	170
Printers	XB07PR - XC09PR	171
Adapters	C-BOX - C-BOX2 - VS-BOX - VS-BOX2 - V-KIT/W - V-KIT/B V-KIT/G - FA64 - FA/CX	171
Filters	FT-IL - FT-PW	172
Transformers	TF3 - TF5 - TF10 - TF10D - TF20D - TF40D	172
Gaskets and protections	MDP/CX - RG-C - RG-R - RG-L - RG-LX - RG-V RG-M - PG-L - PG-MF	172
Light switches	PB-KIT - LS-R - LS-G - LS-Y - CLS-R - CLS-G - CLS-Y CXLS-R - CXLS-G - CXLS-Y - WLS-R - WLS-G - WLS-Y	173
Various	XW-WA - XM-RTC - XM-RTCB - XM-FC16 - XM-FC21 XV-ACK - IPRINT - T92	173





## ACCESSORIES

### MODEMS AND CABLES FOR SYSTEMS AND PROGRAMMABLE CONTROLLERS



<b>XWEB MODEM</b>	for XWEB300D/500D/500 3000/5000 IPG110/115D	Analogue serial modem PDA compatible, 56kbps (DIN Rail format) HOW TO ORDER: XWEBMODEM-200 (with 24Vac power supply) XWEBMODEM-400 (with 110Vac power supply) XWEBMODEM-500 (with 230Vac power supply)	
<b>TC35-KIT</b>	for XWEB300D/500D/500 IPG110/115D	GSM modem kit containing the modem, the power supply unit, the transmitting antenna with the relevant cable and the connection to controlling system	
<b>CAB/WEB/NET</b>	for XWEB300D/500D/500 3000/5000 IPG110/115D	Ethernet patch cable, 3m	
<b>CAB/WEB/PC</b>	for XWEB300D/500D/500 3000/5000 IPG110/115D	Ethernet patch cross over cable, 1m	

### iCOOLL MODULES FOR WIRELESS NETWORK



<b>XJ100</b>	Radio-frequency communication module to use with controllers	
<b>XJ150</b>	Radio-frequency communication module to use with controlling system	
<b>PWS150J</b>	XJ150 power supplier	



## PROGRAMMING KEYS

<b>HOT KEY</b>	Key for a quick and easy Dixell's controllers programming. Dimensions 0,8x16x46mm	
<b>HOT KEY 64</b>	Key for a quick and easy XC200L controllers programming. Dimensions 0,8x16x46mm	
<b>HOT KEY 128</b>	Key for a quick and easy XB570L controller programming. Dimensions 0,8x16x46mm	
<b>VISOKEY</b>	Key for a quick and easy VISOGRAPH display programming. Dimensions 0,8x16x46mm	

## PROGRAMMING KEYBOARD

<b>KB1-PRG</b>	6 keys programming keyboard for XEV series and XJA-XJP-XJR modules	
<b>CAB/KB11</b>	KB1-PRG keyboard cable, 1m	



## PROGRAMMING TOOL

<b>WIZ TOOL KIT</b>	<p>Programming kit made up of CD and DIN Rail module with connections for Hot Key and RS485 for Dixell instruments; it allows the user to connect controllers to a PC running Windows 2000/XP OS. The CD-rom included: <b>WIZMATE</b> (to program an instrument or a Hot Key). The Kit includes: the CAB/PTK2 wire for DIN module instrument connection, the CAB/PTK485 wire for DIN module RS485 (built-in) instrument connection, the CAB/SW9-9 wire for PC connections.</p> <p>How to order: PROG-TOOL 400 (with 110Vac power supply)          PROG-TOOL 500 (with 230Vac power supply)</p>	
---------------------	--	---

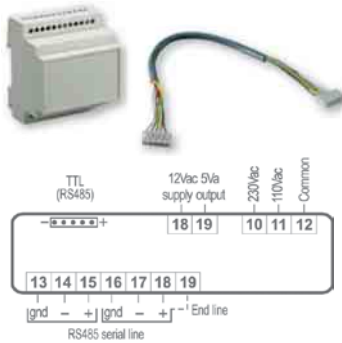







## SERIAL INTERFACE

<b>XJ485CX</b>	The XJ485CX serial interface converts the TTL output into a RS485 signal that can be used to connect the controller to the controlling and supervising system. Dimensions: 1,6x16x46mm. Multipolar connector included, 0,2m	
<b>XJRS485</b>	The XJRS485 opto-insulated serial interface converts the TTL output into a RS485 signal that can be used to connect the controller via an RS485 network to the controlling and supervising system. Format: 4 DIN Rail	 <p>The diagram shows a 19-pin DIN connector for the XJRS485 interface. The pins are labeled as follows:</p> <ul style="list-style-type: none"> <li>Pins 13-15: RS485 serial line (labeled - +   - +   - +)</li> <li>Pins 16-17: 12Vac 5Va supply output (labeled 18   19)</li> <li>Pins 10-11: 230Vac 110Vac Common (labeled 10   11   12)</li> </ul>
<b>CAB/RS1</b>	Multipolar connector for XJRS485, 1m	
<b>CAB/RS2</b>	Multipolar connector for XJRS485, 2m	
<b>CAB/RS3</b>	Multipolar connector for XJRS485, 3m	
<b>CAB/RS5</b>	Multipolar connector for XJRS485, 5m	



## REMOTE DISPLAY

<b>X-REP</b>	Remote display for temperature reading to be used with compatible Dixell's controllers. The front panel is IP65 and makes the installation easy wherever the controlled temperature needs to be displayed. Display: n° digits $\pm$ 3 d.p. Power Supply: from the controller How to order: X-REP-00000 X-REP-10000 (for XJA, XJP)	
<b>CAB/REP1</b>	Multipolar connector for X-REP, 1m; to use with XR100/500C, WING BASIC, XW200/500L, XM, XB series	
<b>CAB/REP3</b>	Multipolar connector for X-REP, 3m; to use with XR100/500C, WING BASIC, XW200/500L, XM, XB series	
<b>CAB/REP5</b>	Multipolar connector for X-REP, 5m; to use with XR100/500C, WING BASIC, XW200/500L, XM, XB series	
<b>CAB51F</b>	Cable for X-REP, 1m; to use with XJA, XJP and PRIME CX series	
<b>CAB52F</b>	Cable for X-REP, 2m; to use with XJA, XJP and PRIME CX series	
<b>CAB55F</b>	Cable for X-REP, 5m; to use with XJA, XJP and PRIME CX series	

## CONNECTIONS

<b>CAB/OS1</b>	Multipolar connector for XR Slave, 1m	
<b>CAB/OS2</b>	Multipolar connector for XR Slave, 2m	
<b>CAB/OS3</b>	Multipolar connector for XR Slave, 3m	
<b>CW15-KIT</b>	Female connectors 12-14 pins with wires 1,5m	
<b>CF-KIT</b>	Female connectors 12-14 pins with faston	
<b>CAB/CJ15</b>	Connector with 1,5m wires for analog output, DI and HP, for XC600 and XC200L	
<b>CAB/CJ30</b>	Connector with 3m wires for analog output, DI and HP, for XC600 and XC200L	
<b>LW30-KIT</b>	3 disconnectable female connectors, 22-8-16 pins with wires 3m for XC200L	
<b>DWA30-KIT</b>	3 disconnectable female connectors, 10-16-22 pins with wires 3m and 2 disconnectable female connectors, 6-8 pins with wires 3m. For IPG110D	
<b>DWB30-KIT</b>	3 disconnectable female connectors, 10-16-22 pins with wires 3m and 3 disconnectable female connectors, 6-8-10 pins with wires 3m. For IPG115D	
<b>DWEX60-30KIT</b>	3 disconnectable female connectors, 8-10-16 pins with wires 3m. For IPROEX60D	
<b>DWXE30</b>	Disconnectable female connectors, 12 pins with wires 3m. For XEV20D	

## PRINTERS

<p><b>XB07PR</b></p>	<p>Compact thermal printer designed for connection to the XB570L controller. It provides a hard copy print out of the cycles. Paper width 58mm. EASYLOCK fixing system that allows to adapt the printer to the panel thickness without further supports. Operating Voltage range: 3.5÷8V. Dimensions: 85.5x85x55mm</p>	
<p><b>XC09PR</b></p>	<p>The XC09PR is an infrared thermal printer suitable for use with XC900M compressor racks controllers. It allows alarms, parameters and data recorded by the instrument to be printed out. Dimensions: 135x125x70mm</p>	



## ADAPTERS

<p><b>C-BOX</b></p>	<p>Wall adapter for C and CX format controllers, IP55, dimensions: 108x108x90mm</p>	
<p><b>C-BOX2</b></p>	<p>Wall adapter for C and CX format controllers, IP55, dimensions: 170x105x82mm</p>	
<p><b>VS-BOX</b></p>	<p>Wall adapter for VS format controllers, IP55, dimensions: 135x74x72mm</p>	
<p><b>VS-BOX2</b></p>	<p>Wall adapter for VS format controllers, IP55, dimensions: 170x105x82mm</p>	
<p><b>V-KIT/W</b></p>	<p>Wall adapter for vertical keyboards, IP55, dimensions: 100x64x43mm, white colour</p>	
<p><b>V-KIT/B</b></p>	<p>Wall adapter for vertical keyboards, IP55, dimensions: 100x64x43mm, black colour</p>	
<p><b>V-KIT/G</b></p>	<p>Wall adapter for vertical keyboards, IP55, dimensions: 100x64x43mm, grey colour</p>	
<p><b>FA64</b></p>	<p>Frame adapter for smaller 31x64 models to fit larger 32x74 instrument cut outs</p>	
<p><b>FA/CX</b></p>	<p>Multifunction frame adapter from L to CX format controllers with the possibility to mount up to 2 CXLS light switches</p>	



## FILTERS

FT-IL	Inductive load filter 0,1 $\mu$ F/100Ohm 250V	
FT-PW	Line filter	

## TRANSFORMERS

TF3	The TF3 3VA model is available in the following versions: 230/12Vac, 110/12Vac and 24/12Vac. Others models with internal thermofuse (130°C) and UL, CSA, VDE approval are available	
TF5	The TF5 5VA model is available in the following versions: 230/12Vac, 110/12Vac and 24/12Vac	
TF10	The TF10 10VA model is available in the following versions: 230/12Vac, 110/12Vac and 24/12Vac	
TF10D	The TF10D (DIN Rail mounting) 10VA model is available in the following versions: 230/24Vac and 110/24Vac. 2 DIN Rail format	
TF20D	The TF20D (DIN Rail mounting) 20VA model is available in the following versions: 230/24Vac and 110/24Vac. 2 DIN Rail format	
TF40D	The TF40D (DIN Rail mounting) 40VA model is available in the following versions: 230/24Vac and 110/24Vac. 4 DIN Rail format	





## GASKETS AND PROTECTIONS

MDP/CX	Plastic protection for C and CX formats against dripping on terminal blocks	
RG-C	Front panel rubber gasket for C format, IP65 mounting	
RG-R	Front panel rubber gasket for R format, IP65 mounting	
RG-L	Front panel rubber gasket for L format, IP65 mounting (STANDARD)	
RG-LX	Front panel rubber gasket for L format, IP65 mounting (INOX)	
RG-V	Front panel rubber gasket for V format, IP65 mounting	
RG-M	Front panel rubber gasket for M format, IP65 mounting	
PG-L	Plastic multipurpose protection for L format, IP65	
PG-MF	Plastic multipurpose protection with protective front cover for M format, IP66	

## LIGHT SWITCHES

<b>PB-KIT</b>	A kit composed by two connectors and a push button, that permits monitoring of the maximum and minimum temperatures and the reset function of the XT115	
<b>LS-R</b>	Red light switch 16A/250Vac	
<b>LS-G</b>	Green light switch 16A/250Vac	
<b>LS-Y</b>	Yellow light switch 16A/250Vac	
<b>CLS-R</b>	Red light switch 16A/250Vac for C format models	
<b>CLS-G</b>	Green light switch 16A/250Vac for C format models	
<b>CLS-Y</b>	Yellow light switch 16A/250Vac for C format models	
<b>CXLS-R</b>	Red light switch 16A/250Vac for FA/CX	
<b>CXLS-G</b>	Green light switch 16A/250Vac for FA/CX	
<b>CXLS-Y</b>	Yellow light switch 16A/250Vac for FA/CX	
<b>WLS-R</b>	Red light switch 16A/250Vac for Wing Series	
<b>WLS-G</b>	Green light switch 16A/250Vac for Wing Series	
<b>WLS-Y</b>	Yellow light switch 16A/250Vac for Wing Series	

## VARIOUS

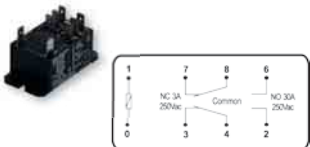
<b>XW-WA</b>	XWEB500 wall mounting bracket	
<b>XM-RTC</b>	Real time clock board for XM series	
<b>XM-RTCB</b>	Real time clock board with lithium battery for XM series	
<b>XM-FC16</b>	Female connectors 16 pins for XM660K and XM670K	
<b>XM-FC21</b>	Female connectors 21 pins for XM669K and XM679K	
<b>XV-ACK</b>	Anti-condensing kit for XV110K and XV150K models	
<b>iPRINT</b>	Hand held infrared reader unit used to download recorded data from the controllers (up to 40) and transfer it directly to a printer provided with IR port. A PC is not required. To use with XR700-XW700 and XLR700 series.	
<b>T92</b>	Relay with a 30A current (3HP/240Vac or 1HP/110Vac) suitable for all those applications where the load current is higher than the rating value of the relays mounted on the instruments. Contacts: 2C/O - 2N/O. Rated current: 30/3 (NO/NC). Rated/max. voltage: 250/480Vac. Rated breaking capacity: 7500VA. Nominal coil voltage: 240Vac. Nominal coil power: 1.7W/4VA. Coil contact: fast-on: 8mm. Dimensions: 30,5x52,3x34,6mm. Ambient temperature: -40÷65°C (-40÷149°F)	

# DIMENSIONS & CUT OUT

## LS, CXLS – PANEL MOUNTING

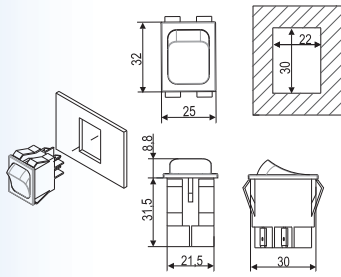

## WLS – PANEL MOUNTING

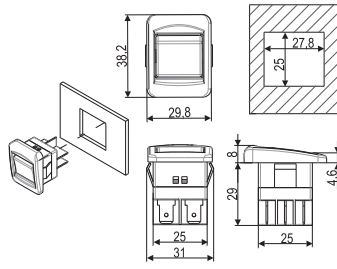

## CLS – PANEL MOUNTING

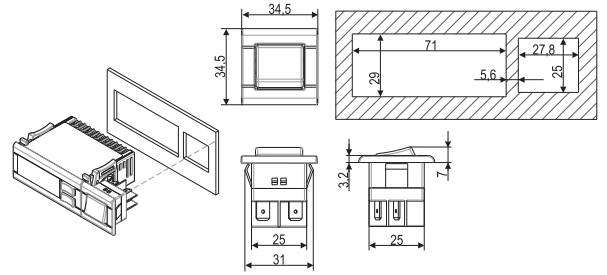

## LC11 (28,5x48) – PANEL MOUNTING

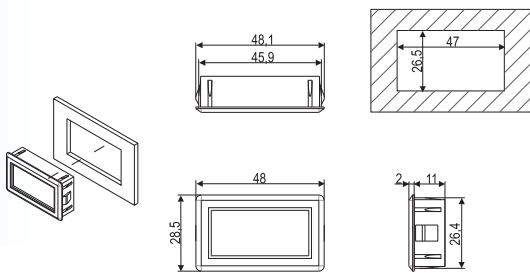

## XT11S, REP (31x64) – PANEL MOUNTING

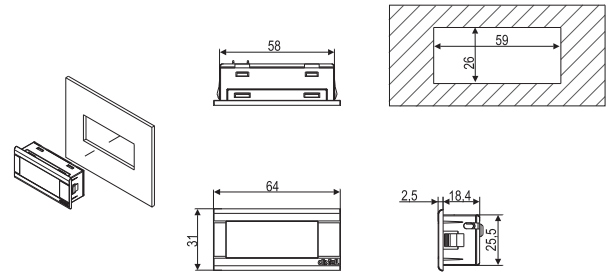

## C (32x74) – PANEL MOUNTING

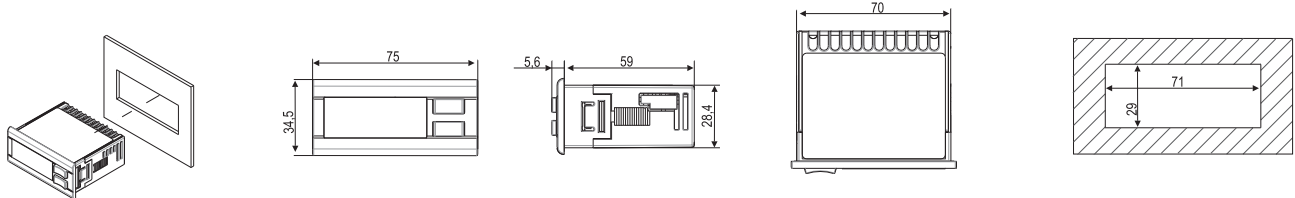

## CX, KEYBOARD (32x74) – PANEL MOUNTING

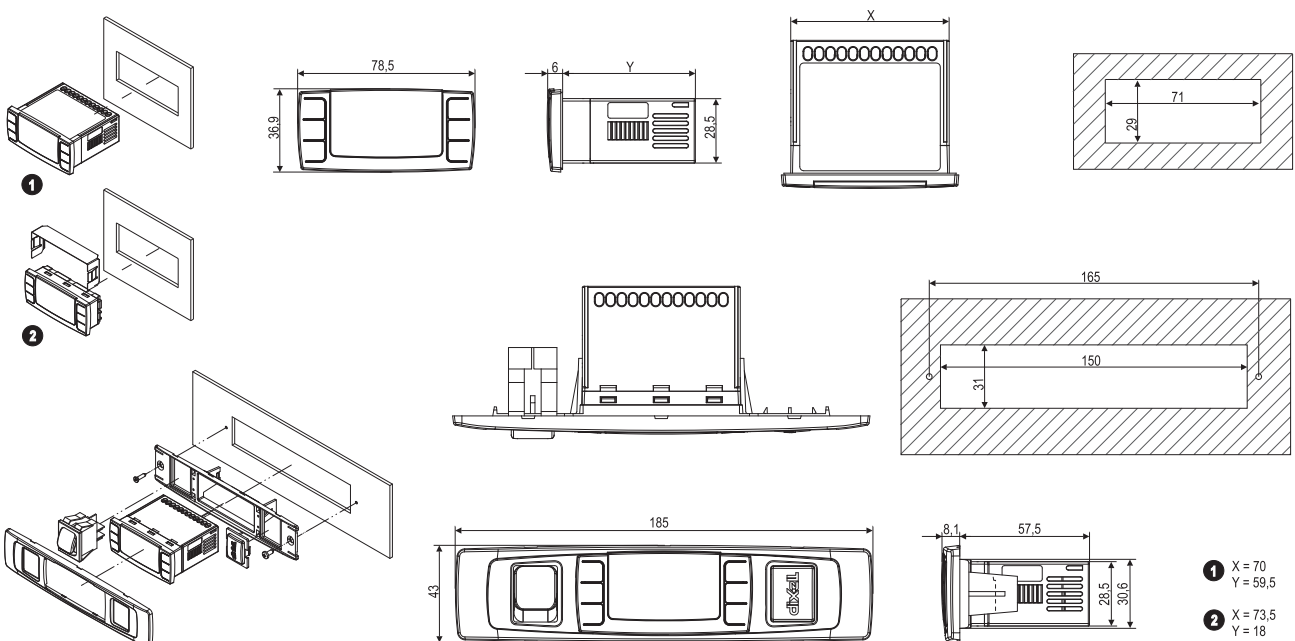

size in mm

### XDL (45x70) – WALL MOUNTING

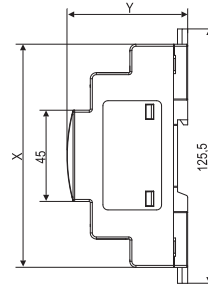
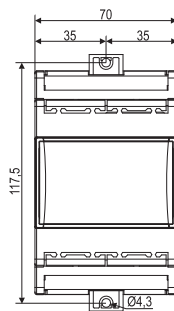
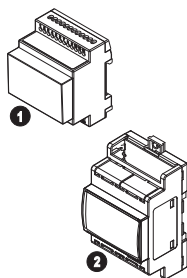
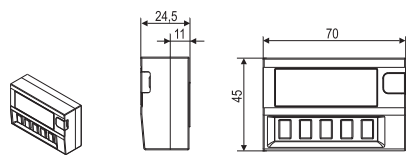

1 X = 84,5  
Y = 64

2 X = 110  
Y = 59,5

### 4 DIN (DIN RAIL) – WALL OR DIN RAIL MOUNTING

### ICOLL (80x56) – WALL MOUNTING

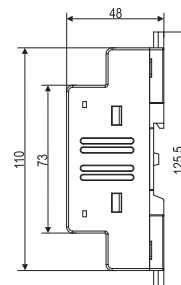
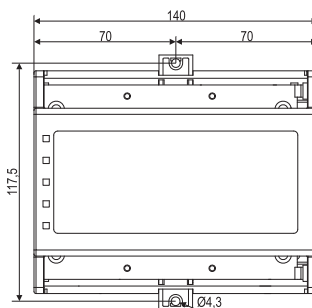
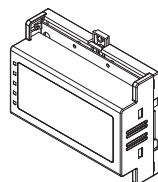
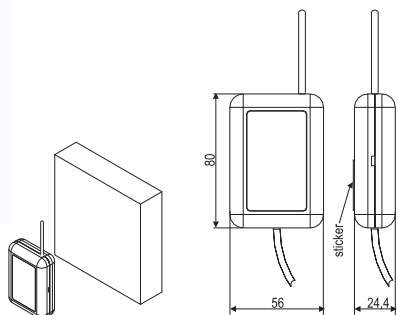

### 8 DIN (DIN RAIL) – WALL OR DIN RAIL MOUNTING

### R (72x72) – PANEL MOUNTING

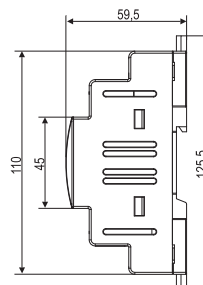
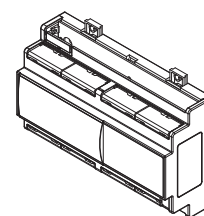
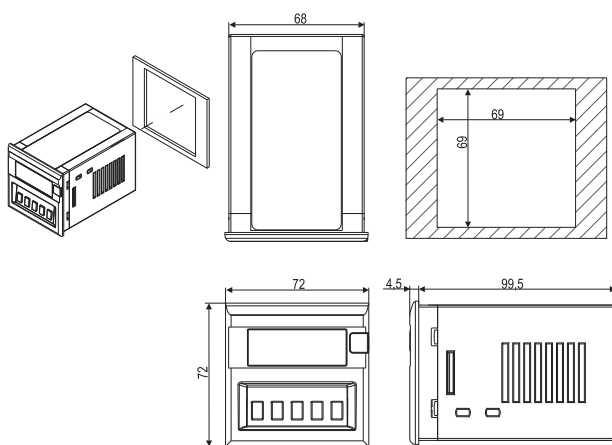

### 10 DIN (DIN RAIL) – WALL OR DIN RAIL MOUNTING

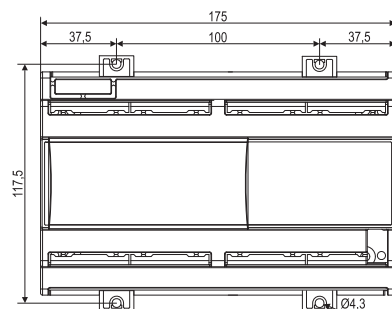

### M (144x72 – 72x144) – PANEL MOUNTING

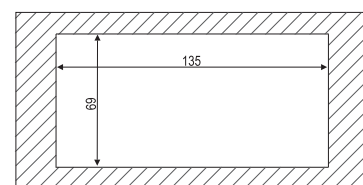
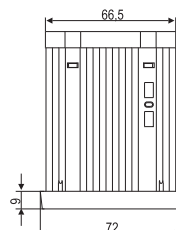
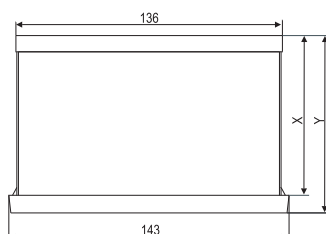
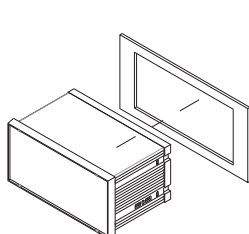

XCM X = 81 Y = 91

XF X = 68 Y = 77

size in mm

## VISOGRAPH (82x156) – WALL OR PANEL MOUNTING

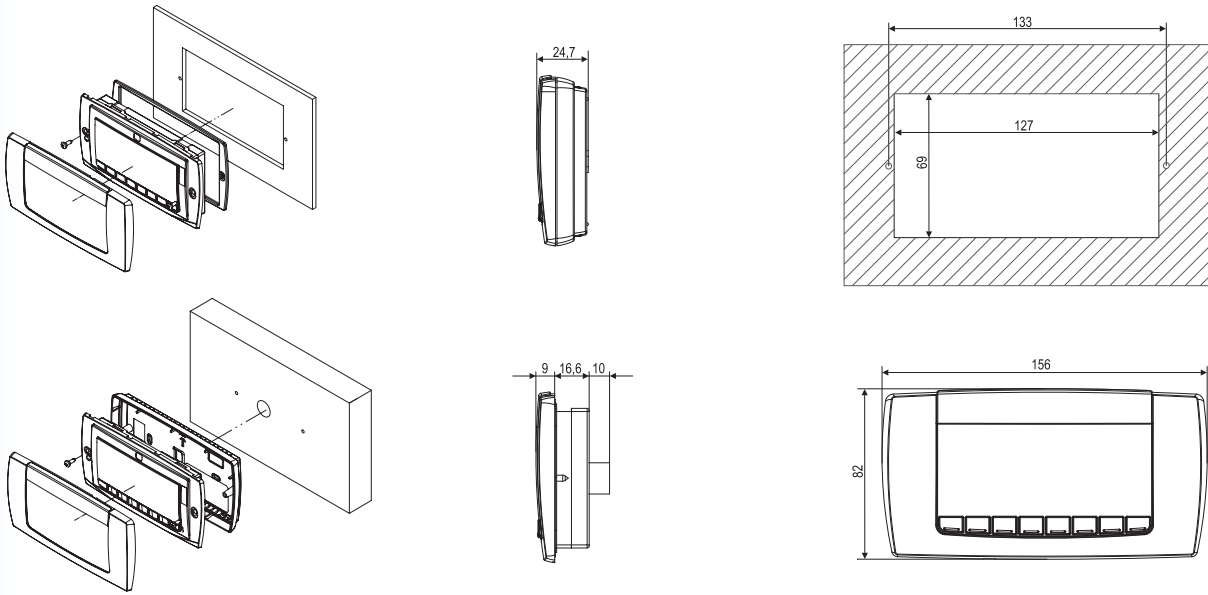

## L, LS, KEYBOARD (38x185) – PANEL MOUNTING

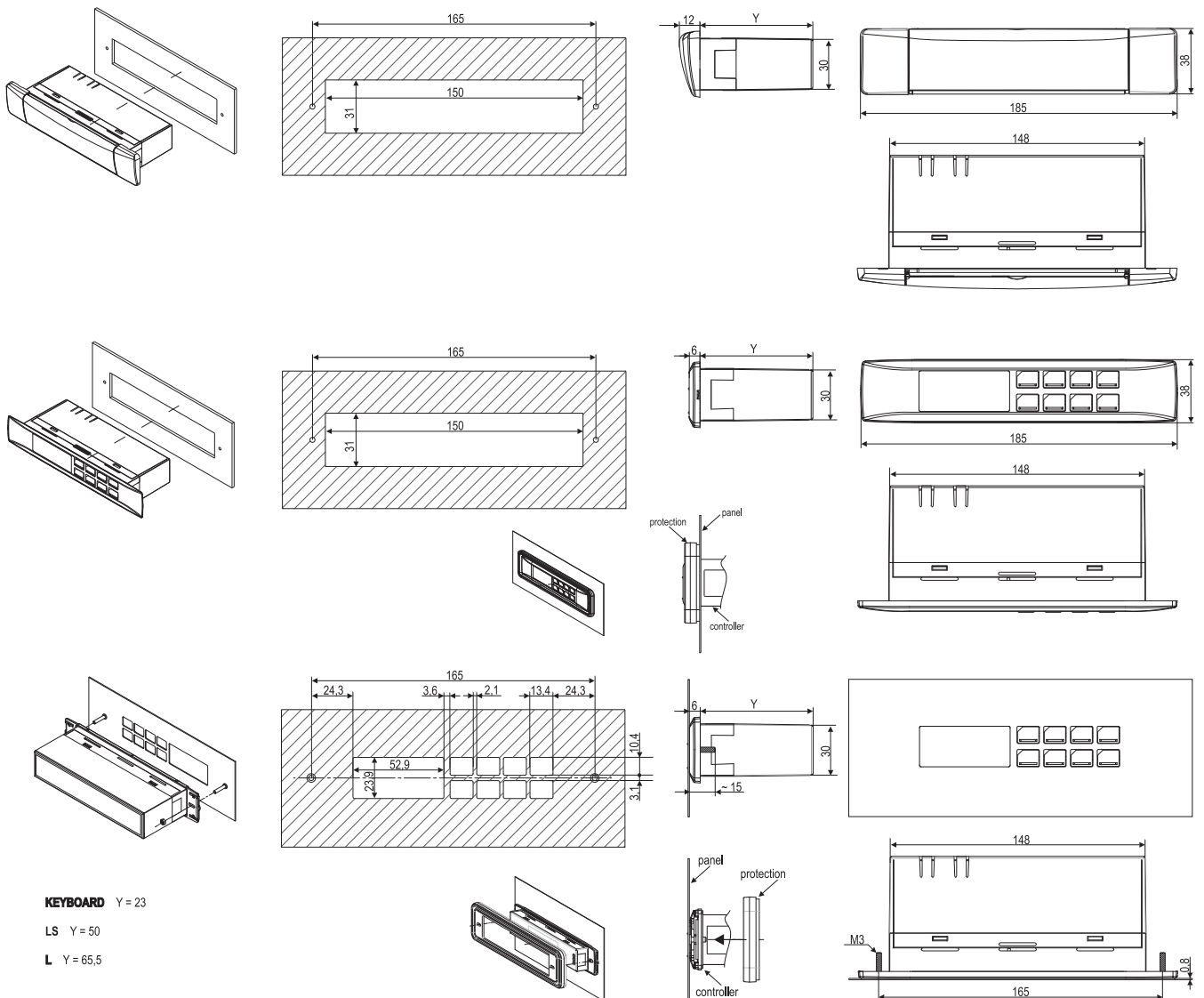

**KEYBOARD** Y = 23

**LS** Y = 50

**L** Y = 65.5

size in mm



V, VS, KEYBOARD (100x64) – PANEL MOUNTING

V-KIT (100x64) – WALL MOUNTING

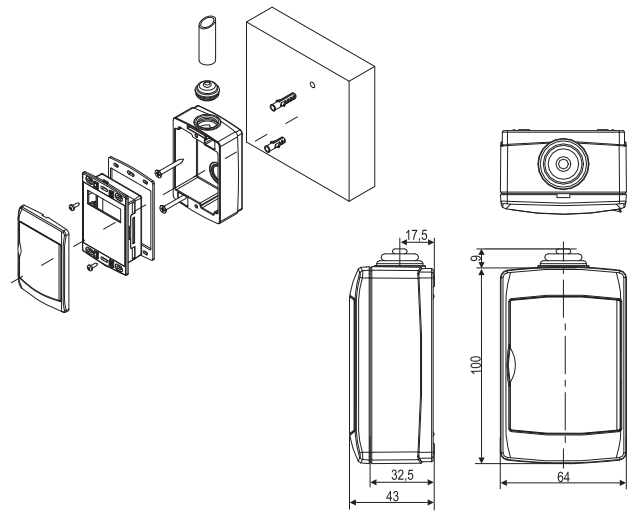
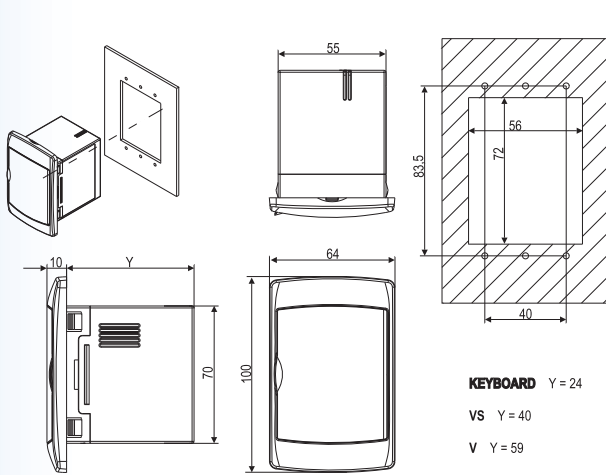

C-BOX (108x108) – WALL MOUNTING

VS-BOX (135x74) – WALL MOUNTING

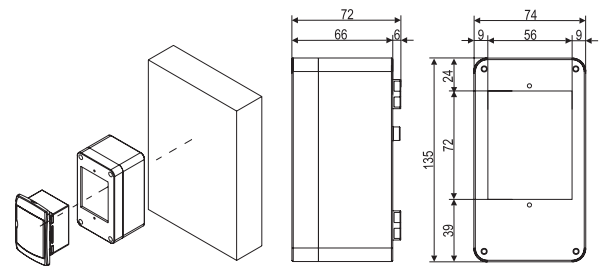
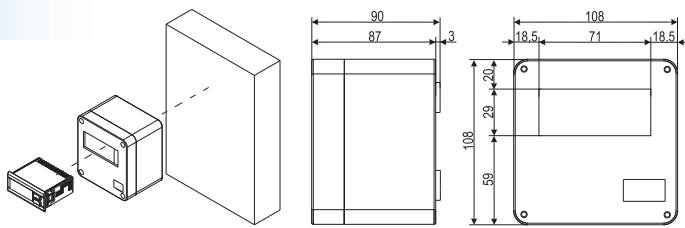

C-BOX2 (170x105) – WALL MOUNTING

VS-BOX2 (135x74) – WALL MOUNTING

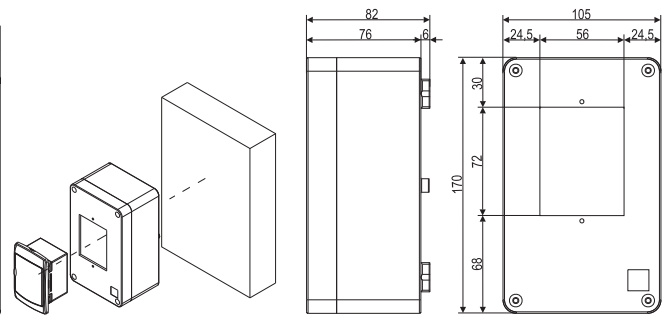
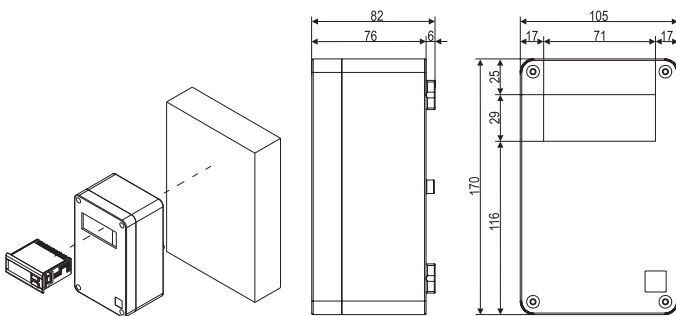

XV110K (118x158)

XV150K (154x200)

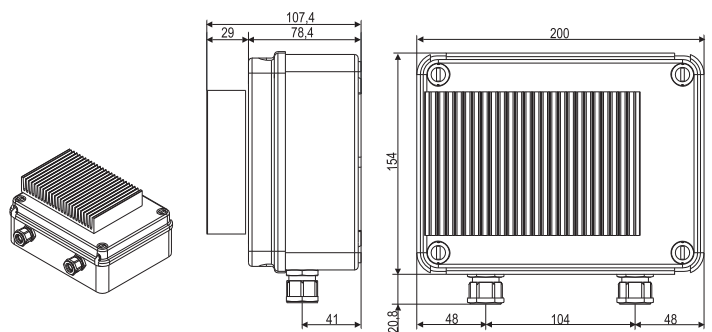
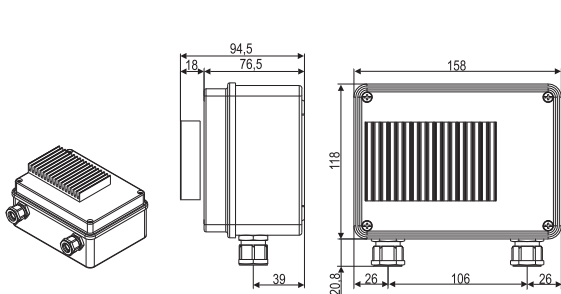

size in mm

**PK (70x80) – PANEL MOUNTING**

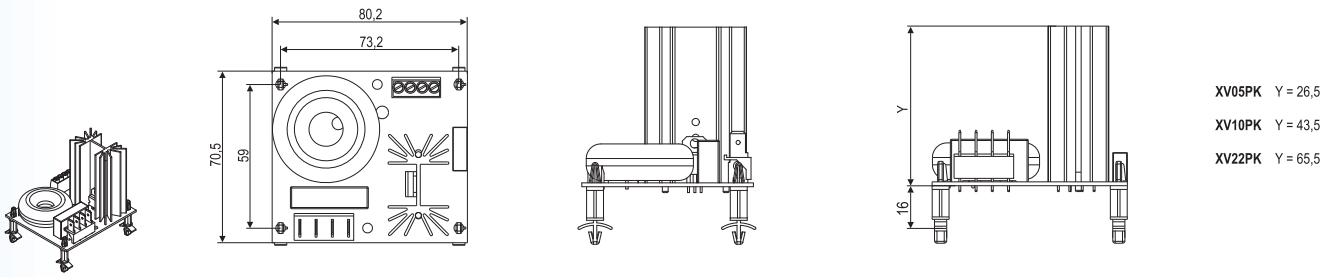

**XLR, XLH, XWEB500 (230x210) – WALL OR PANEL MOUNTING**

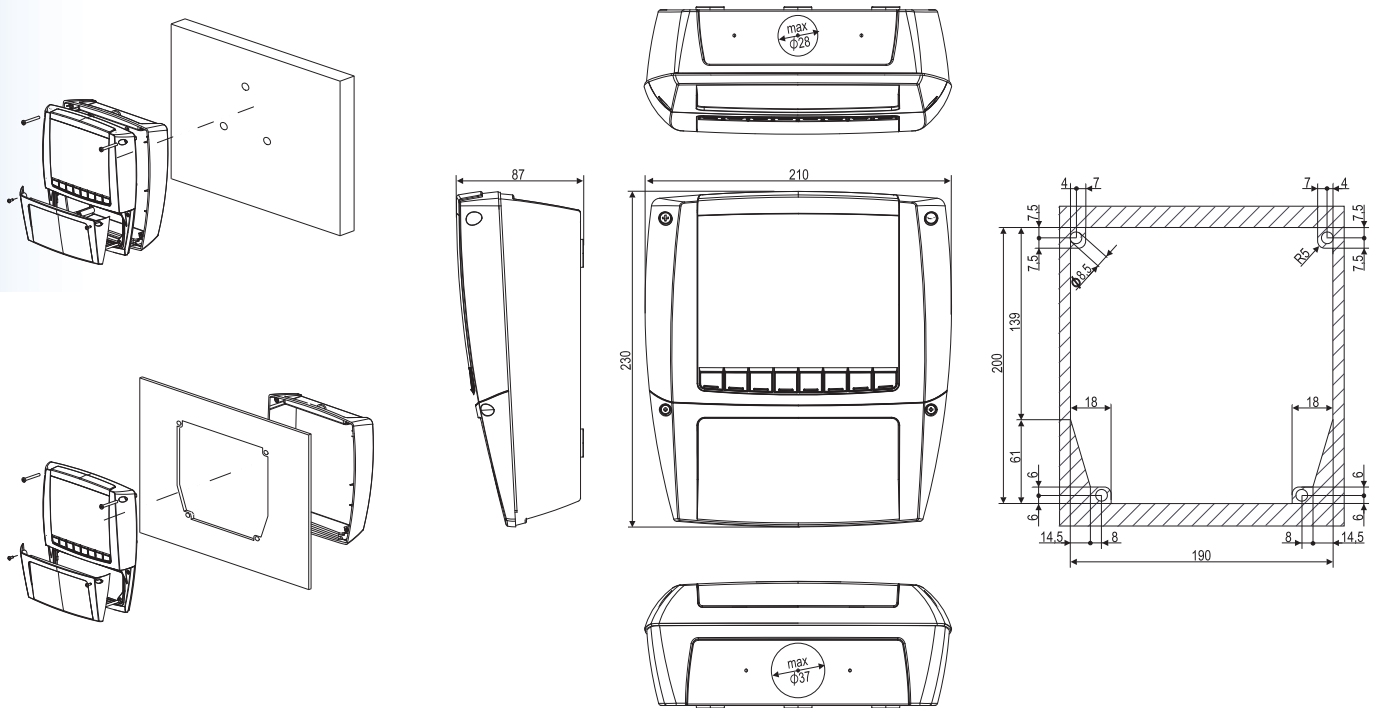

**XWEB3000, XWEB5000 (370x238) – 19" RACK MOUNTING**

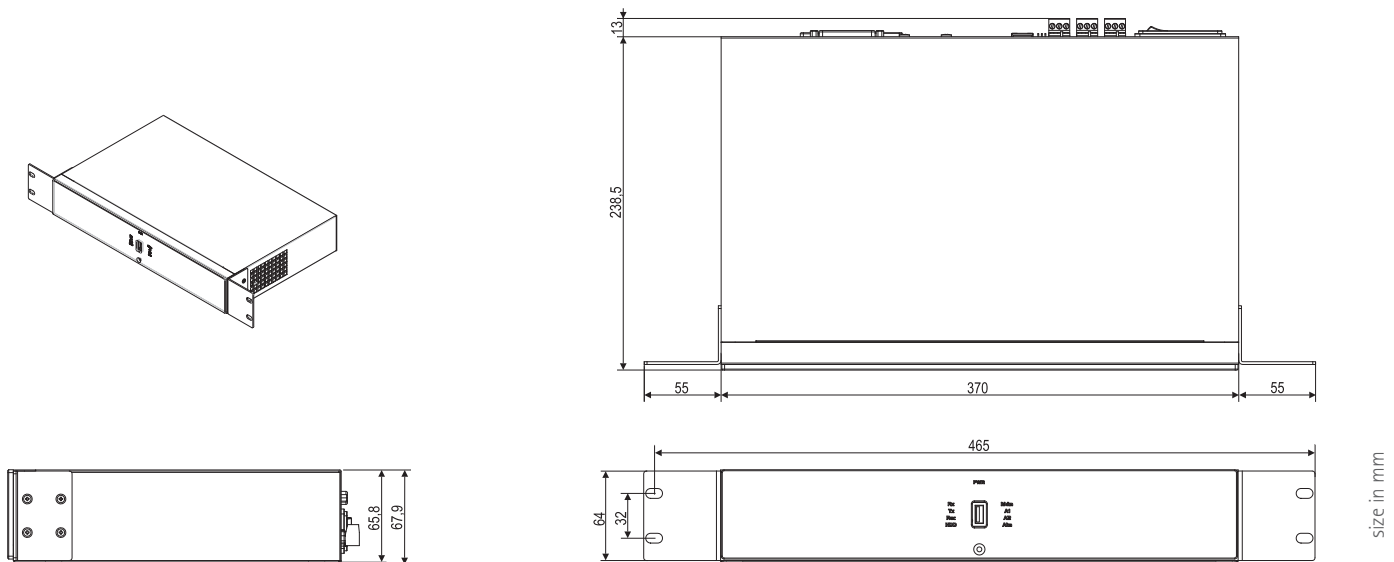

## GENERAL TECHNICAL FEATURES

The following technical features are ordinary for the products present in this catalogue, other main features are write on the preliminary section of the series.

**HOUSING:** self extinguishing ABS

**MOUNTING:** **S, REP formats** panel mounting in a 26x59mm panel cut-out  
**C, CX formats, CX horizontal keyboards** panel mounting in a 29x71mm panel cut-out  
**D format (4, 8, 10 modules)** DIN rail and wall for compatible models  
**L, LS formats, T horizontal keyboards** panel mounting in a 31x150mm panel cut-out  
**V, VS formats, V vertical keyboards** panel mounting in a 72x56mm panel cut-out  
**K format, power modules** panel mounting with screws  
**XLR, XLH formats** panel or wall mounting  
**M format** panel mounting in a 69x135mm panel cut-out  
**R format** panel mounting in a 69x69mm panel cut-out  
**VG format** panel mounting in a 69x127mm panel cut-out or wall mounting

**FRONT PROTECTION:** **S, REP, C, L, LS, V, VS, XLR, XLH, R formats, C and T horizontal keyboards, V vertical keyboards, VG keyboards** IP54 with gasket  
**M format** IP54 with gasket

**DISPLAY:** **single display** red LED  
**dual display** 1st: red LED - 2nd: yellow LED

**ACCURACY:** better than 1% of F.S.

**DATA STORAGE:** EEPROM memory

**OPERATING TEMPERATURE:** 0÷60°C (32÷140°F)

**STORAGE TEMPERATURE:** -30÷85°C (22÷185°F)

**RELATIVE HUMIDITY:** 20÷85%



**MEASUREMENT RANGE:** probe dependent

**Resolution:** 0,1°C or 1°F

**CONNECTIONS:** **C, D, XLR, XLH formats** screw-terminal block  $\leq 2.5\text{mm}^2$   
**M, R formats** disconnectable screw-terminal block  $\leq 2.5\text{mm}^2$   
**L, V, K formats, T horizontal keyboards, V vertical keyboards** screw-terminal block  $\leq 2.5\text{mm}^2$  and 6,3mm faston  
**S, REP, LS, VS formats** 2,8mm and 6,3mm faston

## CORPORATE AND HOMOLOGATIONS

All the production conforms to **CE** norms with regards to low voltage and electromagnetic compatibility. For many models, Dixell has the voluntary mark at approval Authority (**ENEC, usULc**) ensuring a reliable international rules conformance.

	<b>CE mark</b> It indicates conformity to the European Directives issued to guarantee the safety of the users and the environment. It is obligatory for all products distributed within the European Community. It does not replace the voluntary Quality Mark.
	<b>ENEC mark</b> Voluntary quality mark recognised as equivalent to the single national marks of the Countries adherent to the accord. It certifies that a product conforms to the European norms EN, and that it has been manufactured by a company with quality systems conforming to ISO 9000 norms.
	<b>UL mark</b> Voluntary quality mark, valid for the American Market. It certifies conformity of a product to the American safety directives, which sometimes differ from European ones.

Manuals and updating are available on our Web Site.

The continuous improvement of Dixell's products can cause some variations in the information included in this catalogue even without notice.

